

OWNER'S MANUAL

Operation

Maintenance

Specifications

All information in this Owner's Manual is current at the time of publication. However, HYUNDAI reserves the right to make changes at any time without prior notice and without obligation to incorporate such changes so that our policy of continual product improvement may be carried out.

This manual applies to all models of this vehicle and includes descriptions and explanations of optional as well as standard equipment. As a result, you may find material in this manual that does not apply to your specific vehicle.

This booklet is not intended to be a substitute for the Owner's Manual given in QR Code provided at the backside of the cover page.

CAUTION: MODIFICATIONS TO YOUR HYUNDAI

Your HYUNDAI should not be modified in any way. Such modifications may adversely affect the performance, safety or durability of your HYUNDAI vehicle and may, in addition, violate conditions of the limited warranties covering the vehicle. Certain modifications may also be in violation of regulations established by the Department of Transportation and other government agencies in your country.

TWO-WAY RADIO OR CELLULAR TELEPHONE INSTALLATION

Your vehicle is equipped with electronic components. It is possible for an improperly installed/adjusted two-way radio or cellular telephone to adversely affect electronic systems. For this reason, we recommend that you carefully follow the radio manufacturer's instructions or consult your HYUNDAI dealer for precautionary measures or special instructions if you choose to install one of these devices.

SAFETY AND VEHICLE DAMAGE WARNING

This manual includes information titled as DANGER, WARNING, CAUTION and NOTICE. These titles indicate the following:

DANGER

DANGER indicates a hazardous situation which, if not avoided, will result in death or serious injury.

CAUTION

CAUTION indicates a hazardous situation which, if not avoided, could result in minor or moderate injury.

WARNING

WARNING indicates a hazardous situation which, if not avoided, could result in death or serious injury.

NOTICE

NOTICE indicates a situation which, if not avoided, could result in vehicle damage.

TABLE OF CONTENTS - QR CODE

Starting Your Electric Vehicle	H
Hyundai Warranty Policy	1
Your Vehicle at a Glance	2
Safety System of Your Vehicle	3
Convenient Features of Your Vehicle	4
Multimedia System	5
Driving Your Vehicle	6
What to do in an Emergency	7
Maintenance	8
Specifications & Consumer Information	9

FOREWORD

Congratulations, and thank you for choosing HYUNDAI. We are pleased to welcome you to the growing number of discerning people who drive HYUNDAs. We are very proud of the advanced engineering and high-quality construction of each HYUNDAI we build.

Your Owner's Manual will introduce you to the features and operation of your new HYUNDAI. To become familiar with your new HYUNDAI, so that you can fully enjoy it, read this Owner's Manual carefully before driving your new vehicle.

This manual contains important safety information and instructions intended to familiarize you with your vehicle's controls and safety features so you can safely operate your vehicle.

This manual also contains information on maintenance designed to enhance safe operation of the vehicle. It is recommended that all service and maintenance on your car be performed by an authorized HYUNDAI dealer. HYUNDAI dealers are prepared to provide high-quality service, maintenance and any other assistance that may be required.

This Owner's Manual should be considered a permanent part of your vehicle, and should be kept in the vehicle so you can refer to it at any time. The manual should stay with the vehicle if you sell it to provide the next owner with important operating, safety and maintenance information.

CAUTION

Severe vehicle damage may result from the use of poor quality lubricants that do not meet HYUNDAI specifications. You must always use high quality lubricants that meet the specifications listed in the Vehicle Specifications chapter of the Owner's Manual.

HYUNDAI MOTOR COMPANY

Copyright 2023 HYUNDAI Motor Company. All rights reserved. No part of this publication may be reproduced, stored in any retrieval system or transmitted in any form or by any means without the prior written permission of HYUNDAI Motor Company.

VEHICLE MODIFICATIONS

- This vehicle should not be modified. Modification of your vehicle could affect its performance, safety or durability and may even violate governmental safety and vehicle regulations.

In addition, damage or performance problems resulting from any modification may not be covered under warranty.

- If you use unauthorized electronic devices, it may cause the vehicle to operate abnormally, wire damage, battery discharge and fire. For your safety, do not use unauthorized electronic devices.



Starting Your Electric Vehicle

Electric Vehicle	H-3	Charge indicator lamp for electric vehicle	H-14
Electric Vehicle	H-3	Charging Status	H-14
Characteristics of Electric Vehicles	H-3	Charging Connector AUTO/ LOCK Mode	H-16
Battery Information	H-3	Charging connector lock	H-16
Main Components of Electric Vehicle	H-4	Scheduled Charging	H-17
Main Components of Electric Vehicle	H-4	Scheduled Charging	H-17
High Voltage Battery (lithium-ion polymer)	H-5	Precautions for charging electric vehicle	H-18
High Voltage Battery Warmer System	H-6	Charging Precautions	H-18
EV Mode	H-7	Charging electric vehicle (AC charge)	H-20
Energy Information	H-7	AC Charge	H-20
Charge Management	H-8	Charging electric vehicle (DC charge)	H-26
ECO Driving	H-10	DC Charge	H-26
EV settings	H-11	Charging electric vehicle (trickle charge)	H-30
Charge types for electric vehicle	H-12	Trickle Charge	H-30
Charging Information	H-12	Action to be taken when charging stops abruptly ..	H-42
Charging Time Information	H-12	Charging the electric vehicle (abrupt stop)	H-42
Charging Types	H-13		

Driving electric vehicle	H-43
How to Start the Vehicle.....	H-43
How to Stop the Vehicle.....	H-44
Virtual Engine Sound System.....	H-44
Distance to Empty	H-45
Tips for Improving Distance to Empty.....	H-46
Power/Charge Gauge	H-47
State of charge (SOC) gauge for high voltage battery.....	H-47
Warning and Indicator Lights (related to electric vehicle)	H-48
LCD Display Messages.....	H-50
Energy flow.....	H-56
Aux. Battery Saver+.....	H-57
Utility Mode.....	H-59
Safety precautions for electric vehicle	H-61
Countermeasures for Accidents or Fire.....	H-61
Other Precautions for Electric Vehicle.....	H-62
Service Interlock Connector.....	H-63
Service Plug	H-63

ELECTRIC VEHICLE

Electric Vehicle

An electric vehicle is driven using a battery and an electric motor. While general vehicles use an internal combustion engine and gasoline as fuel, electric vehicles use electrical energy that is charged inside the high voltage battery. As a result, electric vehicles are eco-friendly in that they do not require fuel and do not emit exhaust gases.

Characteristics of Electric Vehicles

- 1.It is driven using the electrical energy that is charged inside the high voltage battery. This method prevents air pollution since fuel, like gasoline, is not required, negating the emission of exhaust gases.
- 2.A high performance motor is used in the vehicle as well. Compared to standard, internal combustion engine vehicles, engine noise and vibrations are much more minimal when driving.
- 3.When decelerating or driving downhill, regenerative braking is utilized to charge the high voltage battery. This minimizes energy loss and increases the distance to empty.
- 4.When the battery charge is not sufficient, AC charge, DC charge and trickle charge are available. (Refer to “Charge Types for Electric Vehicle” for details.)

i Information

What does regenerative braking do?

It uses an electric motor when decelerating and braking and transforms kinetic energy to electrical energy in order to charge the high voltage battery. (Torque is applied in the opposite direction when decelerating to generate braking force and electric energy.)

Battery Information

- The vehicle is composed of a high voltage battery that drives the motor and air-conditioner, and an auxiliary battery (12 V) that drives the lamps, wipers, and audio system.
- The auxiliary battery is automatically charged when the vehicle is in the ready () mode or the high voltage battery is being charged.

MAIN COMPONENTS OF ELECTRIC VEHICLE

Main Components of Electric Vehicle

- **On-Board Charger (OBC)** : A device that charges the high voltage battery by converting AC power of the power grid to DC power.
 - **Inverter** : Transforms direct current into alternate current to supply power to the motor, and transforms alternate current into direct current to charge the high voltage battery.
 - **LDC** : Transforms power from the high voltage battery to low voltage (12 V) to supply power to the vehicle (DC-DC).
 - **Motor** : Uses electrical energy stored inside the high voltage battery to drive the vehicle (functions like an engine in a standard vehicle).
 - **Reduction gear** : Delivers rotational force of the motor to the tires at appropriate speeds and torque.
 - **High voltage battery (lithium-ion polymer)** : Stores and supplies power necessary for the electric vehicle to operate (12 V auxiliary battery provides power to the vehicle features such as lights and wipers).
- * OBC : On-Board Charger
* LDC : Low Voltage DC-DC Converter

WARNING

- **Do not intentionally remove or disassemble high voltage components and high voltage battery connectors and wires. Also, be careful not to damage high voltage components and the high voltage battery. It may cause serious injury and significantly impact the performance and durability of the vehicle.**
- **When inspection and maintenance is required for high voltage components and the high voltage battery, we recommend that you contact an authorized HYUNDAI dealer.**

High Voltage Battery (lithium-ion polymer)

- The charge amount of the high voltage battery may gradually decrease when the vehicle is not driving.
- The battery capacity of the high voltage battery may decrease when the vehicle is stored in high/low temperatures.
- Distance to empty may vary depending on the driving conditions, even if the charge amount is the same. The high voltage battery may expend more energy when driving at high-speed or uphill. These actions may reduce the distance to empty.
- The high voltage battery is used when using the air-conditioner / heater. This may reduce the distance to empty. Make sure to set moderate temperatures when using the air-conditioner/heater.
- Natural degradation may occur with the high voltage battery depending on the number of years the vehicle is used. This may reduce the distance to empty.
- When the charge capacity and distance to empty keep falling, we recommend that you contact an authorized HYUNDAI dealer for inspection and maintenance.
- If the vehicle will not be in use for an extended period of time, charge the high voltage battery once every three months to prevent it from discharging. Also, if the charge amount is not enough, immediately charge to full and store the vehicle.
- AC charge is recommended to keep the high voltage battery in optimal condition.
If the high voltage battery charge amount is below 20%, you can keep the high voltage battery performance in optimal condition if you charge the high voltage battery to 100%. (Once a month or more is recommended.)

MAIN COMPONENTS OF ELECTRIC VEHICLE (CONT.)

CAUTION

- **Make sure to use a designated charger when charging the high voltage battery. Using different types of chargers may have a serious impact on vehicle durability.**
- **Make sure that the high voltage battery charger gauge does not reach "L (Low) or 0". If the vehicle is kept at "L (Low) or 0" for a long period, it may damage the high voltage battery and the high voltage battery may have to be replaced depending on the level of degradation.**
- **If the vehicle is in a collision, we recommend that you contact an authorized HYUNDAI dealer to inspect whether the high voltage battery is still connected.**

High Voltage Battery Warmer System

The high voltage battery warmer system prevents reduction of battery output when battery temperature is low. If the charging connector is connected, the warmer system automatically operate according to the battery temperature.

Charging time may shorten compare to vehicles without the high voltage battery warmer system. But, electricity charge may increase because of high voltage battery warmer system operation.

CAUTION

The high voltage battery warmer system operates when the charging connector is connected to the vehicle.

However, the high voltage warmer system may not operate when battery temperature drops below -35°C (-31°F).

EV MODE



If you select the "EV" menu at the home screen you can enter EV mode.

For details on EV Mode, refer to the Multimedia manual that is provided separately.



The EV mode has a total of 4 menus, Energy information, Charge management, ECO driving and EV settings.

* EV mode menu may vary depending on which functions are applicable to your vehicle.

Energy Information



Select 'EV → Energy information' on the screen.

You can check battery information and energy consumption.

EV MODE (CONT.)

Battery information



You can check the reachable range, total battery power remaining, and expected charging time for each charge type.

- The distance to empty is calculated based on the real-time fuel efficiency while driving. The distance may change if the driving pattern changes.
- The distance to empty may vary according to the change of the driving pattern even if the same target battery charge level is set.

Charge Management



Select 'EV → Charge management' on the screen. You can set the date and time of when to charge the battery, climate control temperature, location-based charging options and other various functions.

Charging and climate

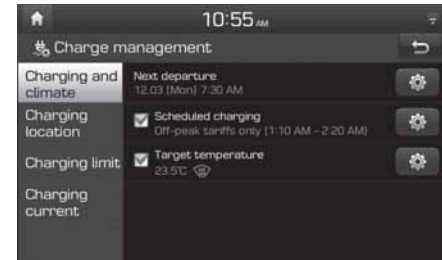

You can set the date and time of when to charge the battery and the climate control temperature. Also, you may select the time to start charging using the off-peak time setting.



Departure time

1. Set anticipated departure time for scheduled charging and target temperature.
2. Select the day of the week to activate scheduled charging and target temperature for departure time.



Target temperature settings

1. Set target temperature.

Off-peak time settings

1. If selected, starts charging only on the designated off-peak time
If deselected, starts charging only on the scheduled time
2. Set the most inexpensive time to complete charging
3.
 - Off-peak tariffs prioritised: If selected, starts charging at off-peak time (may keep on charging pass off-peak time to charge 100%)
 - Off-peak tariffs only: If selected, charges only within off-peak time (may not charge 100%)

EV MODE (CONT.)

Charging limit

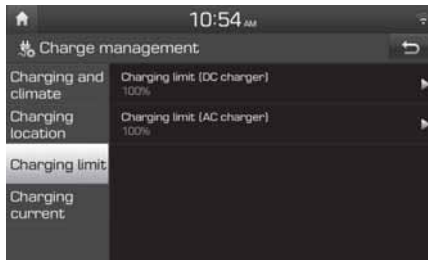

- The target battery charge level can be selected when charged with AC charger or DC charger
- The charging level can be changed by 10%.
- If the target battery charge level is lower than the high voltage battery charge level, the battery will not be charged.

Charging current

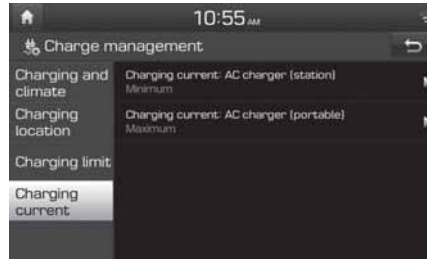

- You can adjust the charging current for an AC charger. Select an appropriate charging current for the charger used.
- If the charging process does not start or abruptly stops in the middle, re-select another proper current and re-try charging the vehicle.
- Charging time varies depending on which charging current is selected

ECO Driving



Select 'EV → ECO Driving' on the screen. You can check the CO2 reduction and ECO driving history.

CO2 reduction



You can check CO₂ reduction information compared to the gasoline vehicle of similar size.

Driving history

The screenshot shows the 'ECO driving' app interface. At the top, it says 'ECO driving' and '10:46 AM'. Below that, there are two tabs: 'CO₂ reduction' and 'History'. The 'History' tab is selected, showing a list of driving trips. The list has three columns: date, distance, and energy consumption. The first row is highlighted with a star icon.

Date	Distance	Energy consumption
02.03.2018	13 km	21.1 km/kWh
26.02.2018	31 km	18.6 km/kWh
★ 24.02.2018	25 km	22.8 km/kWh
15.02.2018	21 km	19.8 km/kWh
14.02.2018	12 km	17.5 km/kWh

You can check the date, driving distance and the energy efficient rating of the previous driving trips. The date with the highest energy efficient driving is marked with a star shaped icon.

EV settings (if equipped)

Select 'EV → EV settings' on the screen. You can select or deselect the Winter mode.

Winter mode increase the battery temperature in advance when you implement scheduled chargings or climate controls in winter time. This will enhance charging and driving performance. Using this feature drains the battery faster.

CHARGE TYPES FOR ELECTRIC VEHICLE

Charging Information

- **AC Charge :**

The electric vehicle is charged by plugging into a AC charger installed in your home or a public charging station. (For further details, refer to the 'AC Charge'.)

- **DC Charge :**

You can charge at high speeds at public charging stations. Refer to the respective company's manual that is provided for each DC charger type.

Battery performance and durability can deteriorate if the DC charger is used constantly.

Use of DC charge should be minimized in order to help prolong high voltage battery life.

- **Trickle Charge :**

The Electric vehicle can be charged by using household electricity. The electrical outlet in your home must comply with regulations and can safely accommodate the Voltage / Current (Amps) / Power (Watts) ratings specified on the portable charge.









Charging Time Information

Charging type		Economical battery type	Extended battery type
AC charge		Takes approx. 6 hours 10 minutes at room temperature when charged to 100%.	Takes approx. 9 hours 35 minutes at room temperature when charged to 100%.
DC charge	100 kW charger	Takes about 54 minutes at room temperature when charged to 80%. Can be charged to 100%.	Takes about 54 minutes at room temperature when charged to 80%. Can be charged to 100%.
	50 kW charger	Takes about 57 minutes at room temperature when charged to 80%. Can be charged to 100%.	Takes about 75 minutes at room temperature when charged to 80%. Can be charged to 100%.
Trickle charge		Takes approx. 19 hours at room temperature when charged to 100%.	Takes approx. 31 hours at room temperature when charged to 100%.

i Information

Depending on the condition and durability of the high voltage battery, charger specifications, and ambient temperature, the time required for charging the high voltage battery may vary.

Charging Types

Category	Charging inlet (Vehicle)	Charging connector	Charging outlet	How to charge
AC Charge	 OOSEVQ018003L	 OAEEQ016078L	 OLFP0Q5007K	Use AC charger installed in homes or public charging stations
DC Charge	 OOSEVQ018004L	 OAEEQ016022L	 OAEEQ016023	Use the DC charger at public charging stations
Trickle Charge	 OOSEVQ018003L	 OAEEQ016078L	 OAEEQ016024	Use household current

- Depending on the condition and durability of the high voltage battery, charger specifications, and ambient temperature, the time required for charging the high voltage battery may vary.
- Actual charger image and charging method may vary in accordance with the charger manufacturer.





CHARGE INDICATOR LAMP FOR ELECTRIC VEHICLE

Charging Status











When charging the high voltage battery, the charge level can be checked from outside the vehicle.

Charging status

Lamp status	Details
 white ON	Charging door open (charging standby)
 green ON	Charging
 green blink	Scheduled charging set
 red blink	Charging error (charging system malfunction)
 yellow ON	Charging 12 V auxiliary battery or scheduled air conditioner/heater is operating

Charging level

Lamp status		Details
Before charging (illuminate)	While charging (blink)	
		High voltage battery level very low
yellow	yellow	
		High voltage battery level low
green	green	
		High voltage battery level middle
green	green	
		High voltage battery level high
green	green	

High voltage warning

Lamp status	Details
	High voltage electricity flowing (Charging 12 V auxiliary battery or scheduled air conditioner/heater is operating)

Immediate charging

Lamp status	Details
	Scheduled charging deactivation button Press to charge immediately.

CHARGING CONNECTOR LOCK

Charging Connector AUTO/ LOCK Mode



You may select when the charging connector can be locked and unlocked in the charging inlet.

Press the  button to change between AUTO mode and LOCK mode.

Information

The charging inlet is locked during the DC charge regardless of AUTO/ LOCK mode. After charging is complete the locked charging inlet is unlocked.

When the Charging Connector Is Locked

	LOCK	AUTO
Before charging	O	X
While charging	O	O
Finished charging	O	X

- LOCK mode (button indicator off) :
The connector locks when the charging connector is plugged into the charging inlet. The connector is locked until all doors are unlocked by the driver. This mode can be used to prevent charging cable theft.
 - If the charging connector is unlocked when all doors are unlocked, but the charging cable is not disconnected within 15 seconds, the connector will be automatically locked again.
 - If the charging connector is unlocked when all doors are unlocked, but all doors are locked again, immediately, the connector will be automatically locked again.

- AUTO mode (button indicator on) :
The connector locks when charging starts. The connector unlocks when charging is complete. This mode can be used when charging in a public charging station.

SCHEDULED CHARGING

Scheduled Charging (if equipped)

- You can set-up a charging schedule for your vehicle using the Audio or Navigation screen or Blue Link application.

Refer to the Multimedia manual or the Blue Link manual for detailed information about setting scheduled charging.

- Scheduled charging can only be done when using a AC charger or the portable charger (ICCB: In-Cable Control Box).



- When scheduled charging is set and the AC charger or the portable charger (ICCB: In-Cable Control Box) is connected for charging, the indicator lamp blinks in green (1) for 3 minutes to indicate that scheduled charging is set.
- When scheduled charging is set, charging is not initiated immediately when the AC charger or portable charger (ICCB: In-Cable Control Box) is connected. When immediate charging is required, use the Audio or Navigation screen to deactivate the scheduled charge setting or press schedule charging deactivation button (2) for 3 seconds.

- If you press the scheduled charging deactivation button (2) to immediately charge the battery, charging must be initiated 3 minutes after the charging cable has been connected.

When you press the scheduled charging deactivation button (2) for immediate charging, the scheduled charge setting is not completely deactivated. If you need to completely deactivate the scheduled charge setting, use the Audio or Navigation screen to finalize the deactivation.

Refer to "AC Charge (Station) or Trickle Charge" for details about connecting the AC charger and the portable charger (ICCB: In-Cable Control Box).

PRECAUTIONS FOR CHARGING ELECTRIC VEHICLE

Charging Precautions

■ AC Charger



OLFP0Q5007K

■ DC Charger



OAEQ016023

Actual charger image and charging method may vary in accordance with the charger manufacturer.

⚠ WARNING

- Electromagnetic waves that are generated from the charger can seriously impact medical electric devices such as an implantable cardiac pacemaker.

If you are fitted with any electronic medical implants (for example, cardiac pacemaker), make sure to ask the medical team and manufacturer whether charging your electric vehicle will impact the operation of electronic medical implants.

- Check to make sure there is no water or dust on the charging cable connector and plug before connecting to the charger and charging inlet. Connecting while there is water or dust on the charging cable connector and plug may cause a fire or electric shock.

⚠ WARNING

- Be careful not to touch the charging connector, charging plug, and the charging inlet when connecting the cable to the charger and the charging inlet on the vehicle.
- Comply with the following in order to prevent electrical shock when charging:
 - Use a waterproof charger.
 - Do not touch the charging connector and charging plug with your hands wet, or do not stand in water or snow while connecting the charging cable.
 - Be careful when there is lightning.
 - Be careful when the charging connector and plug is wet.

 **WARNING**

- Immediately stop charging when you find abnormal symptoms (odor, smoke).
- Replace the charging cable if the cable coating is damaged to prevent electrical shock.
- When connecting or removing the charging cable, make sure to hold the charging connector handle and charging plug. If you pull the cable itself (without using the handle), the internal wires may be disconnected or get damaged. This may lead to electric shock or fire.

 **CAUTION**

- Always keep the charging connector and charging plug in clean and dry condition. Be sure to keep the charging cable in a condition where there is no water or moisture.
- Make sure to use the designated charger for charging the electric vehicle. Using any other charger may cause failure.
- Before charging the battery, turn the vehicle OFF.
- When the vehicle is switched OFF while charging, the cooling fan inside the motor compartment may automatically operate. Do not touch the cooling fan while charging.
- Be careful not to drop the charging connector. The charging connector can be damaged.

CHARGING ELECTRIC VEHICLE (AC CHARGE)

AC Charge

■ AC Charger



OLFP0Q5007K

Actual charger image and charging method may vary in accordance with the charger manufacturer.

How to Connect AC Charger

1. Depress the brake pedal and apply the parking brake.
2. Turn OFF all switches, shift to P (Park), and turn OFF the vehicle.
If charging is initiated without the gear in P (Park), the charging will start after the gear is automatically shifted to P (Park).



©OSEVQ018008L

3. Push the charging door where the icon is located to open. The charging door opens only when the door is unlocked.

i Information

If you cannot open the charging door due to freezing weather, tap lightly or remove any ice near the charging door. Do not try to forcibly open the charging door.



4. Remove the charging inlet cover (1).
5. Check if there is dust on the charging connector and charging inlet.
6. Hold the charging connector handle and connect it to the vehicle charging inlet. Push the connector all the way in. If the charging connector and charging terminal are not connected properly, this may cause a fire.

i Information

Charging connector AUTO/LOCK mode

The charging connector is locked in the inlet at a different period according to which mode is selected.

- **LOCK mode** : The connector locks when the charging connector is plugged into the charging inlet.
- **AUTO mode** : The connector locks when charging starts.

For more details, refer to “Charging Connector AUTO/ LOCK Mode” in this chapter.



7. Connect the charging plug to the electric outlet at an AC charging station to start charging.

CHARGING ELECTRIC VEHICLE (AC CHARGE) (CONT.)



8. Check if the charging indicator light of the high voltage battery on the instrument cluster is turned ON. Charging is not done when the charging indicator lamp is OFF.

When the charging connector and charging plug are not connected properly, reconnect the charging cable to charge.

i Information

- During AC charging, the radio reception may be poor.
- During charging, the gear cannot be shifted from P (Park) to any other gear.



9. After charging has started, the estimated charging time is displayed on the instrument cluster for about 1 minute.

If you open the driver seat door while charging, the estimated charging time is also displayed on the instrument cluster for about 1 minute. When scheduled charging or scheduled air conditioning/heating is set, the estimated charging time is displayed as "--" .

i Information

Depending on the condition and durability of the high voltage battery, charger specifications, and ambient temperature, the time required for charging the battery may vary.

Checking Charging Status



When charging the high voltage battery, the charge level can be checked from outside the vehicle.

Lamp status		Details
Before charging (illuminate)	While charging (blink)	
		High voltage battery level very low
yellow	yellow	
		High voltage battery level low
green	green	
		High voltage battery level middle
green	green	
		High voltage battery level high
green	green	

CHARGING ELECTRIC VEHICLE (AC CHARGE) (CONT.)

How to Disconnect AC Charger

■ AC Charger



1. When charging is complete, remove the charging plug from the electrical outlet of the AC charging station.



2. Hold the charging connector handle and pull it out.

i Information

To prevent charging cable theft, the charging connector cannot be disconnected from the inlet when the doors are locked. Unlock all doors to disconnect the charging connector from the inlet.

However, if the vehicle is in the charging connector AUTO mode, the charging connector automatically unlocks from the inlet when charging is completed.

For more details, refer to “Charging Connector AUTO/ LOCK Mode” in this chapter.



3. Make sure to install the charging inlet cover.
4. Make sure to completely close the charging door.

Unlock Charging Connector in Emergency

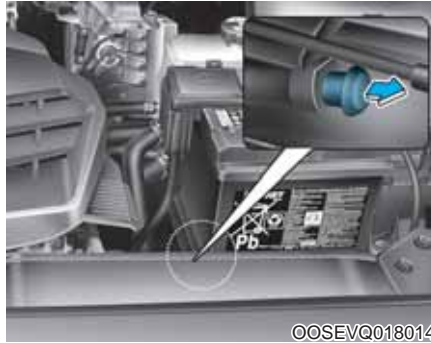

If the charging connector does not disconnect due to battery discharge and failure of the electric wires, open the hood and slightly pull the emergency cable. The charging connector will then disconnect.

CHARGING ELECTRIC VEHICLE (DC CHARGE)

DC Charge

■ DC Charger



You can charge at high speeds at public charging stations. Refer to the respective company's manual that is provided for each DC charger type.

Battery performance and durability can deteriorate if the DC charger is used constantly.

Use of DC charge should be minimized in order to help prolong high voltage battery life.

Actual charger image and charging method may vary in accordance with the charger manufacturer.

i Information

If you use a DC charger when the vehicle is already fully charged, some DC chargers will send out an error message. When the vehicle is fully charged, do not charge the vehicle.

How to Connect DC Charger

1. Depress the brake pedal and apply the parking brake.
2. Turn OFF all switches, shift to P (Park), and turn OFF the vehicle.



3. Push the charging door where the icon is located to open. The charging door opens only when the door is unlocked.

i Information

If you cannot open the charging door due to freezing weather, tap lightly or remove any ice near the charging door. Do not try to forcibly open the charging door.



4. Remove the charging inlet cover (1).
5. Check whether there is dust or foreign substances inside the charging connector and charging inlet.
6. Hold the charging connector handle and connect it to the vehicle charging inlet. Push the connector all the way in. If the charging connector and charging terminal are not connected properly, this may cause a fire.

Refer to the manual for each type of DC charger for how to charge and remove the charger.



7. Check if the charging indicator light of the high voltage battery in the instrument cluster is turned ON. Charging is not done when the charging indicator lamp is OFF.

When the charging connector is not connected properly, reconnect the charging cable to charge it again.

During cold weather, DC charging may not be available to prevent high voltage battery degradation.

CHARGING ELECTRIC VEHICLE (DC CHARGE) (CONT.)

i Information

To control the temperature of the high voltage battery while charging or when the battery temperature is high, the air conditioning is used to cool down the battery. This may generate noise or vibration from operation of the air conditioning compressor and cooling fan, but it is a normal condition when charging the high voltage battery. Also, the air conditioning performance may be degraded due to operation of the cooling system to charge the high voltage battery. This is a normal condition.

i Information

During charging, the gear cannot be shifted from P (Park) to any other gear.



8. After charging has started, the estimated charging time is displayed on the instrument cluster for about 1 minute.

If you open the driver seat door while charging, the estimated charging time is also displayed on the instrument cluster for about 1 minute.









i Information

Depending on the condition and durability of the high voltage battery, charger specifications, and ambient temperature, the time required for charging the battery may vary.

Checking Charging Status



When charging the high voltage battery, the charge level can be checked from outside the vehicle.

Lamp status		Details
Before charging (illuminate)	While charging (blink)	
		High voltage battery level very low
yellow	yellow	
		High voltage battery level low
green	green	
		High voltage battery level middle
green	green	
		High voltage battery level high
green	green	

How to Disconnect DC Charger

1. Remove the charging connector when DC charging is completed, or after you stop charging using the DC charger. Refer to each respective DC charger manual for details about how to disconnect the charging connector.



2. Make sure to install the charging inlet cover.
3. Make sure to completely close the charging door.

CHARGING ELECTRIC VEHICLE (TRICKLE CHARGE)

Trickle Charge

■ Portable Charger



- (1) Code and Plug (Code set)
- (2) Control Box
- (3) Charging Cable and Charging Connector

Trickle Charge can be used when AC Charge or DC Charge is not available by using household electricity.

How to Set the Charge Level of the Portable Charger

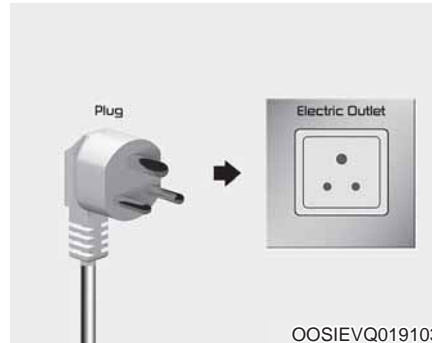

1. Check the rated current of the electric outlet prior to connecting the plug to the outlet.
2. Connect the plug to a household electric outlet.
3. Check the display window on the control box.



4. Press the button (1) on the back of the control box for more than 1 second to adjust the charge level. (Refer to charging cable type and example for setting the charge level.)
5. The charge level on the display window of the control box changes every time you press the button (1).
6. When setting the charge level is complete, start charging according to the trickle charge instructions.

*Example for setting the ICCB charge level

The example is only for reference and may vary according to the surrounding environment.

Outlet current	ICCB charge level	Control box display window
14-16A	12A	 OOSEVQ018055
13-12A	10A	
11-10A	8A	
9-8A	6A	

How to Connect Portable Charger (ICCB: In-Cable Control Box)

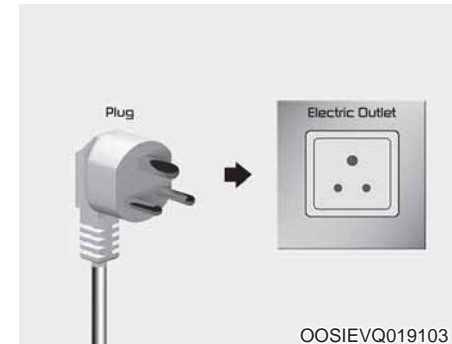

1. Connect the plug to a household electric outlet.

CHARGING ELECTRIC VEHICLE (TRICKLE CHARGE) (CONT.)



2. Check if the power lamp (green) illuminates on the control box.
3. Depress the brake pedal and apply the parking brake.
4. Turn OFF all switches, shift to P (Park), and turn OFF the vehicle.

If charging is initiated without the gear in P (Park), the charging will start after the gear is automatically shifted to P (Park).



5. Push the charging door where the icon is located to open. The charging door opens only when the door is unlocked.

i Information

If you cannot open the charging door due to freezing weather, tap lightly or remove any ice near the charging door. Do not try to forcibly open the charging door.



6. Remove the charging inlet cover (1).
7. Check if there is dust on the charging connector and charging inlet.
8. Hold the charging connector handle and connect it to the vehicle charging inlet. Push the connector all the way in. If the charging connector and charging terminal are not connected properly, this may cause a fire.

i Information

Charging connector AUTO/LOCK mode

The charging connector is locked in the inlet at a different period according to which mode is selected.

- **LOCK mode** : The connector locks when the charging connector is plugged into the charging inlet.
- **AUTO mode** : The connector locks when charging starts.

For more details, refer to “Charging Connector AUTO/ LOCK Mode” in this chapter.



9. Charging starts automatically (charging lamp blinks).



10. Check if the charging indicator light of the high voltage battery in the instrument cluster is turned ON. Charging is not done when the charging indicator lamp is OFF.

When the charging connector is not connected properly, reconnect the charging cable to charge it again.

i Information

During charging, the gear cannot be shifted from P (Park) to any other gear.

CHARGING ELECTRIC VEHICLE (TRICKLE CHARGE) (CONT.)



11. After charging has started, the estimated charging time is displayed on the instrument cluster for about 1 minute.

If you open the driver seat door while charging, the estimated charging time is also displayed on the instrument cluster for about 1 minute. When scheduled charging or scheduled air conditioner/heater is set, the estimated charging time is displayed as "--" .









i Information

Depending on the condition and durability of the high voltage battery, charger specifications, and ambient temperature, the time required for charging the battery may vary.

Checking Charging Status















When charging the high voltage battery, the charge level can be checked from outside the vehicle.

Lamp status		Details
Before charging (illuminate)	While charging (blink)	
		High voltage battery level very low
yellow	yellow	
		High voltage battery level low
green	green	
		High voltage battery level middle
green	green	
		High voltage battery level high
green	green	





CHARGING ELECTRIC VEHICLE (TRICKLE CHARGE) (CONT.)

Charging Status Indicator Lamp for Portable Charger

Control Box	Indicator		Details			
	PLUG	 (Green)	On : Power on Blink : Plug temperature sensor failure			
		 (Red)	On : Plug high temperature protection Blink : Plug high temperature warning			
	POWER	 POWER	On : Power on			
	CHARGE	 CHARGE	Blink : Charging In power saving mode, only the CHARGE indicator is illuminated.			
	FAULT	 FAULT	Blink : Charging interrupted			
	CHARGE LEVEL	 12A	Type A	Type B	Type C	The charging current changes (3 level) whenever the button (1) is pressed for 1 sec with the charger plugged into an electrical outlet but not the vehicle.
		 10A	12 A	10 A	8 A	
		 8A	10 A	8 A	7 A	
	VEHICLE	 (Green)	Charging connector plugged			
		 (Blue)	Charging			
 (Red)		Blink : Charging impossible				







Charging Status Indicator Lamp for Portable Charger

NO	Control Box	Status / Diagnosis / Countermeasure	NO	Control Box	Status / Diagnosis / Countermeasure
1		<ul style="list-style-type: none"> • Charging connector plugged into vehicle (Green ON) • Plug temperature sensor failure (Green blink) • Plug high temperature protection (Red blink) • Plug high temperature warning (Red ON) <p>We recommend that you contact an authorized HYUNDAI dealer.</p>	2		<ul style="list-style-type: none"> - Charging connector plugged into vehicle (Green ON)
3		<ul style="list-style-type: none"> - While charging • Charge indicator (Green blink) • Vehicle indicator (Blue ON) 	4		<ul style="list-style-type: none"> - Before plugging charging connector into vehicle (Red blink) • Abnormal temperature • ICCB (In-Cable Control Box) failure <p>We recommend that you contact an authorized HYUNDAI dealer.</p>

CHARGING ELECTRIC VEHICLE (TRICKLE CHARGE) (CONT.)

Charging Status Indicator Lamp for Portable Charger

NO	Control Box	Status / Diagnosis / Countermeasure	NO	Control Box	Status / Diagnosis / Countermeasure
5		<ul style="list-style-type: none"> - Plugged into vehicle (Red blink) • Diagnostic device failure • Current leakage • Abnormal temperature <p>We recommend that you contact an authorized HYUNDAI dealer.</p>	6		<ul style="list-style-type: none"> - After plugging charging connector into vehicle (Red blink) • Communication failure <p>We recommend that you contact an authorized HYUNDAI dealer.</p>
7		<ul style="list-style-type: none"> • Plug temperature sensor failure (Green blink) • Plug high temperature protection (Red blink) • Plug high temperature warning (Red ON) <p>We recommend that you contact an authorized HYUNDAI dealer.</p>	8		<ul style="list-style-type: none"> - Power saving mode • 3 minutes after charging starts (Green blink)

How to Disconnect Portable Charger (ICCB: In-Cable Control Box)



1. Hold the charging connector handle and pull it out.

i Information

To prevent charging cable theft, the charging connector cannot be disconnected from the inlet when the doors are locked. Unlock all doors to disconnect the charging connector from the inlet.

However, if the vehicle is in the charging connector AUTO mode, the charging connector automatically unlocks from the inlet when charging is completed.

For more details, refer to “Charging Connector AUTO/ LOCK Mode” in this chapter.



2. Make sure to install the charging inlet cover.
3. Make sure to completely close the charging door.

CHARGING ELECTRIC VEHICLE (TRICKLE CHARGE) (CONT.)

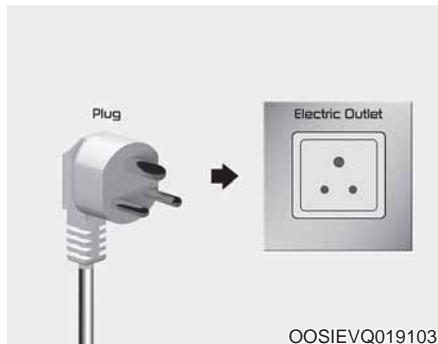

4. Disconnect the plug from the household electric outlet. Do not pull the cable when disconnecting the plug.
5. Close the protective cover for the charging connector so that foreign material cannot get into the terminal.
6. Put the charging cable inside the cable compartment to protect it.

Disconnecting Charging Connector in Emergency

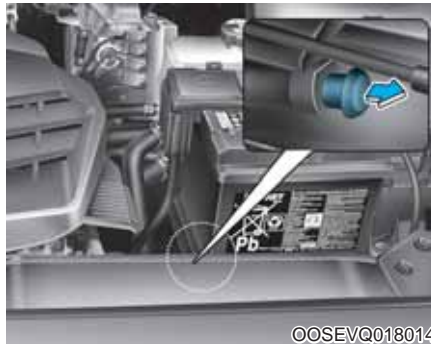

If the charging connector does not disconnect from the charging inlet due to battery discharge and failure of electric wires, open the hood and slightly pull the emergency cable. The charging connector will be disconnected from the charging inlet.

Precautions for Portable Charger (ICCB: In-Cable Control Box)

- Use the portable charger that is certified by HYUNDAI Motors.
- Do not try to repair, disassemble, or adjust the portable charger.
- Do not use an extension cord or adapter.
- Stop using immediately when failure occurs.
- Do not touch the plug and charging connector with wet hands.
- Do not touch the terminal part of the AC charging connector and the AC charging inlet on the vehicle.
- Do not connect the charging connector to voltage that does not comply with regulations.
- Do not use the portable charger if it is worn out, exposed, or there exists any type of damage on the portable charger.

- If the ICCB case and AC charging connector is damaged, cracked, or the wires are exposed in any way, do not use the portable charger.
- Do not let children operate or touch the portable charger.
- Keep the control box free of water.
- Keep the normal charging connector or plug terminal free of foreign substances.
- Do not step on the cable or cord. Do not pull the cable or cord and do not twist or bend it.
- Do not charge when there is lightning.
- Do not drop the control box or place a heavy object on the control box.
- Do not place an object that can generate high temperatures near the charger when charging.
- Charging with the worn out or damaged household electric outlet can result in a risk of electric shock. If you have doubts about the condition of a household electric outlet, have it checked by a licensed electrician.
- Stop using the portable charger immediately if the household electric outlet or any components is overheated or you notice burnt odors.

CHARGING THE ELECTRIC VEHICLE (ABRUPT STOP)

Action to be taken when charging stops abruptly

When the high voltage battery does not charge, check the followings:

1. Check the charging setting for the vehicle. Refer to “Charge Management”, in this chapter (for example, When scheduled charging is set, charging is not initiated immediately when the AC charger or portable charger (ICCB: In-Cable Control Box) is connected.)
2. Check the operation status of AC charger, portable charger and DC charger.
(Charging Status Indicator Lamp for Portable Charger, refer to “Checking Charging Status” for trickle charge in this chapter.)
* Actual method for indicating the charging status may vary in accordance with the charger manufacturer.
3. When the vehicle does not charge and a warning message appears on the cluster, check the corresponding message. Refer to “LCD Display Messages”, in this chapter.
4. If the vehicle is properly charged when charged with another normally working charger, contact the charger manufacturer.
5. If the vehicle does not charge when charged with another normally working charger, we recommend that you contact an authorized HYUNDAI dealer for inspection.

DRIVING ELECTRIC VEHICLE

How to Start the Vehicle

1. Holding the smart key, sit in the driver's seat.
2. Fasten the seat belt before starting the vehicle.
3. Make sure to engage the parking brake.
4. Turn OFF all electrical devices.
5. Make sure to depress and hold the brake pedal.
6. While depressing the brake pedal, shift to P (Park).
7. Depress and hold the brake pedal while pressing the START/STOP button.

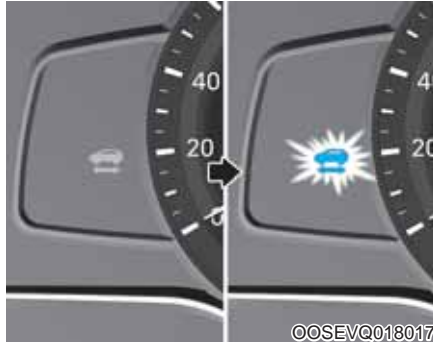

8. When the "P" indicator is ON, you can drive the vehicle.
When the "P" indicator is OFF, you cannot drive the vehicle. Start the vehicle again.
9. Depress and hold the brake pedal and shift to the desired position.

i Information

While the charging cable is connected, the gear cannot be shifted from P (Park) to any other gear for safety reasons.

10. Release the parking brake and slowly release the brake pedal. Check if the vehicle slowly moves forward, then depress the accelerator pedal.

DRIVING ELECTRIC VEHICLE (CONT.)

How to Stop the Vehicle

1. Hold down the brake pedal while the vehicle is parked.
2. While depressing the brake pedal, shift to P (Park).
3. While depressing the brake pedal, engage the parking brake.
4. While depressing the brake pedal, press the START/STOP button and turn off the vehicle.

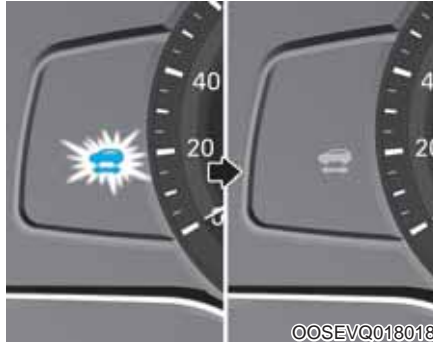

5. Check if the "⚡" indicator is turned OFF on the instrument cluster.

When the "⚡" indicator is ON and the gear is in a position other than P (Park), the driver can accidentally depress the accelerator pedal, causing the vehicle to move unexpectedly.

Virtual Engine Sound System



The Virtual Engine Sound System generates engine sound for pedestrians to hear vehicle sound because there is no sound while the Electric Vehicle (EV) is operating.

- The VESS may be turned ON or OFF by pressing the VESS button. (if equipped)
- If the vehicle is in the ready (⚡) mode and the gear is not in P (Park), the VESS will operation.
- When the gear is shifted to R (Reverse), an additional warning sound will be heard.

CAUTION

- For safety reasons, do not turn off the VESS system. If you are in a situation that the system needs to be turned off, check whether there are pedestrians around the vehicle.
- The vehicle is much quieter whilst driving than a conventional gasoline-powered vehicle. Be aware of your surroundings and always drive safely.
- After you park the vehicle or whilst you are waiting at a traffic light, check whether there are children or obstacles around the vehicle.
- Check if there is something behind the vehicle when driving in reverse. Pedestrians may not hear the sound of the vehicle.

Distance to Empty



The distance to empty is displayed differently according to the selected drive mode in the Drive Mode Integrated Control System.

For more information, refer to “Drive Mode Integrated Control System” in chapter 5.

When destination is not set

- On average, a vehicle can drive about 241 km (Economical type) / 400 km (Extended type).

Under certain circumstances where the air conditioner/heater is ON, the distance to empty is impacted, resulting in a possible distance range from 175~340 km (Economical type) / 335~500 km (Extended type). When using the heater during cold weather or driving at high speed, the high voltage battery consumes a lot more electricity. This may reduce the distance to empty significantly.

- After “---” has been displayed, the vehicle can drive an additional 3~8 km (2~5 miles) depending on driving speed, heater/air conditioner, weather, driving style, and other factors.

DRIVING ELECTRIC VEHICLE (CONT.)

- Distance to empty that is displayed on the instrument cluster after completing a recharge may vary significantly depending on previous operating patterns.

When previous driving patterns include high speed driving, resulting in the high voltage battery using more electricity than usual, the estimated distance to empty is reduced. When the high voltage battery uses little electricity in ECO mode, the estimated distance to empty increases.

- Distance to empty may depend on many factors such as the charge amount of the high voltage battery, weather, temperature, durability of the battery, geographical features, and driving style. When the ambient temperature is low such as in winter, the actual driving distance may reduce due to degradation of the battery.
- Natural degradation may occur with the high voltage battery depending on the number of years the vehicle is used. This may reduce the distance to empty.

When destination is set

When the destination is set, the distance to empty may change. The distance to empty is recalculated using the information of the destination. However, the distance to empty may vary significantly based on traffic conditions, driving habits, and condition of the vehicle.

Tips for Improving Distance to Empty

- If you operate the air conditioner / heater too much, the driving battery uses too much electricity. This may reduce the distance to empty. Therefore, it is recommended that you set the cabin temperature to 22°C AUTO. This setting that has been certified by various assessment tests to maintain optimal energy consumption rates while keeping the temperature fresh.
Turn OFF the heater and air conditioner if you do not need them.
- When the heater or air conditioning system is on the energy consumption is reduced if recirculation mode is selected instead of selecting the fresh mode. The fresh mode requires large amount of energy consumption as the outside air has to be re-heated or cooled.
- When using the heater or air conditioning system use the DRIVER ONLY or scheduled air conditioner/ heater function.

- Depress and hold the accelerator pedal to maintain speed and drive economically.
- Gradually depress and release the accelerator pedal when accelerating or decelerating.
- Always maintain specified tire pressures.
- Do not use unnecessary electrical components while driving.
- Do not load unnecessary items in the vehicle.
- Do not mount parts that may increase air resistance.

Power/Charge Gauge



The Power/Charge Gauge shows the energy consumption rate of the vehicle and the charge/discharge status of the regenerative brakes.

- **POWER :**

It shows the energy consumption rate of the vehicle when driving uphill or accelerating. The more electric energy is used, the higher the gauge level.

- **CHARGE :**

It shows the charging status of the battery when it is being charged by the regenerative brakes (decelerating or driving on a downhill road). The more electric energy is charged, the lower the gauge level.

State of charge (SOC) gauge for high voltage battery



- The SOC gauge shows the charging status of the high voltage battery.

"L (Low)" position on the indicator indicates that there is not enough energy in the high voltage battery. "H (High)" position indicates that the driving battery is fully charged.

- When driving on highways or motorways, make sure to check in advance if the driving battery is charged enough.

DRIVING ELECTRIC VEHICLE (CONT.)



When there are 2 gauge bars (near the "L (Low)" area) on the SOC gauge, the warning lamp turns ON to alert you of the battery level.

When the warning lamp turns ON, the vehicle can drive an additional 20~30 km (12~18 miles) depending on the driving speed, heater/air conditioner, weather, driving style, and other factors. Charging is required.

NOTICE

When there are 1-2 gauge bars left for the high voltage battery, the vehicle speed is limited and then eventually the vehicle will turn OFF. Charge the vehicle immediately.

Warning and Indicator Lights (related to electric vehicle)

Ready Indicator



This indicator illuminates :

When the vehicle is ready to be driven.

- ON : Normal driving is possible.
- OFF : Normal driving is not possible, or a problem has occurred.
- Blinking : Emergency driving.

When the ready indicator goes OFF or blinks, there is a problem with the system. In this case, we recommend that you have your vehicle inspected by an authorized HYUNDAI dealer.

Service Warning Light



This warning light illuminates :

- When the START/STOP button is in the ON position.
 - It illuminates for approximately 3 seconds and then goes off.
- When there is a problem with related parts of the electric vehicle control system, such as sensors, etc.

When the warning light illuminates while driving, or does not go OFF after starting the vehicle, we recommend that you have your vehicle inspected by an authorized HYUNDAI dealer.

Power Down Indicator Light



This indicator light illuminates :

- When the START/STOP button is in the ON position.
 - It illuminates for approximately 3 seconds and then goes off.
- When the power is limited for the safety of the electric vehicle.

The power is limited for the following reasons.

 - The high voltage battery level is below a certain level or voltage is decreasing
 - The temperature of the motor or high voltage battery is too high or too low
 - There is a problem with the cooling system, or a failure that may interrupt normal driving

NOTICE

- **Do not accelerate or start the vehicle suddenly when the power down warning light is ON.**
- **When the power is limited for the safety of the high-powered parts of an electric vehicle, the power down indicator light illuminates. Your vehicle may not be driven, or may roll back on a slope with the indicator light ON due to the limitation of vehicle power.**

Charging Indicator Light

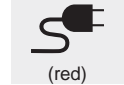

This warning light illuminates :

- When charging the high voltage battery.

High Voltage Battery Level Warning Light



This warning light illuminates :

- When the high voltage battery level is low.

When the warning light turns ON, charge the battery immediately.

DRIVING ELECTRIC VEHICLE (CONT.)

Regenerative Brake Warning Light



This warning light illuminates :

When the regenerative brake does not operate and the brake does not perform well. This causes the Brake Warning light (red) and Regenerative Brake Warning Light (yellow) to illuminate simultaneously.

In this case, drive safely and we recommend that you have your vehicle inspected by an authorized HYUNDAI dealer.

The operation of the brake pedal may be more difficult than normal and the braking distance can increase.

LCD Display Messages Shift to P to charge



This message is displayed if you connect the charging cable without the gear in the P (Park) position.

Shift to P (Park) before connecting the charging cable.

Remaining time

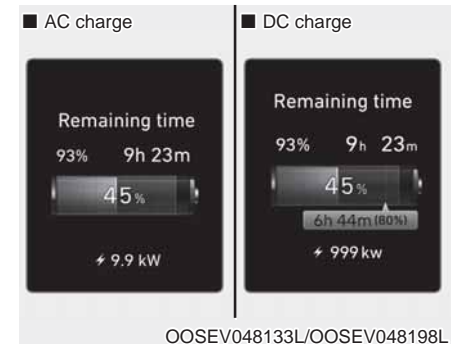

This message displays how much time remains until the battery is charged to the selected target battery charge level.

Unplug vehicle to start



This message is displayed when you start the vehicle without unplugging the charging cable. Unplug the charging cable, and then turn on the vehicle.

Charging door open



This message is displayed when the vehicle is driven with the charging door opened. Close the charging door and then start driving.

Charging stopped. Check the AC/DC charger

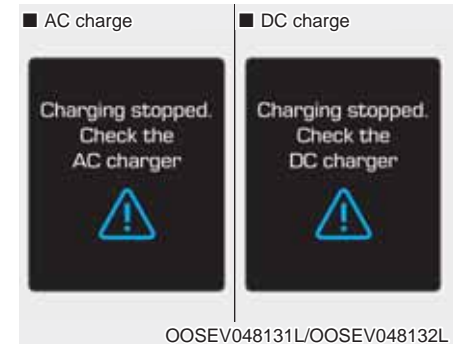

- This warning message is displayed when charging is stopped for the reasons below:
 - There is a problem with the external AC charger or DC charger
 - The external AC charger stopped charging
 - The charging cable is damaged

In this case, check whether there is any problem with the external AC or DC charger and charging cable.

DRIVING ELECTRIC VEHICLE (CONT.)

If the same problem occurs when charging the vehicle with a normally operating AC charger or genuine HYUNDAI portable charger, we recommend that you have your vehicle inspected by an authorized HYUNDAI dealer.

Charging stopped. Check the cable connection



This warning message is displayed when charging is stopped because the charging connector is not correctly connected to the charging inlet

In this case, separate the charging connector and re-connect it and check whether there is any problem (external damage, foreign substances, etc.) with the charging connector and charging inlet.

If the same problem occurs when charging the vehicle with a replaced charging cable or genuine HYUNDAI portable charger, we recommend that you have your vehicle inspected by an authorized HYUNDAI dealer.

Check regenerative brakes / Stop vehicle and check brakes



This warning message is displayed when the regenerative brake system does not work properly.

In this case, we recommend that you have the vehicle inspected by an authorized HYUNDAI dealer.

Low battery



When the high voltage battery level reaches below approximately 8%, this warning message is displayed.

The warning light on the instrument cluster (🔋) will turn ON simultaneously.

Charge the high voltage battery immediately.

Charge immediately. Power limited



When the high voltage battery level reaches below approximately 3%, this warning message is displayed.

The warning light on the instrument cluster (🔋) and the power down warning light (⊖) will turn on simultaneously.

The vehicle's power will be reduced to minimize the energy consumption of the high voltage battery. Charge the battery immediately.

Low outside temp. may limit power output. Charge EV battery/ Low battery temperature. Power limited

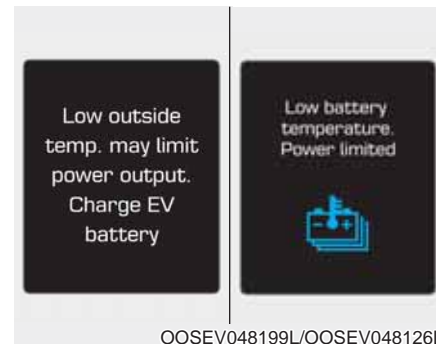

[A] : Displays when turning off vehicle.

[B] : Displays when turning on vehicle.

Both warning messages are displayed to protect electric vehicle system when outside temperature is low. If the high voltage battery charging level is low and parked outside in low temperature for a long time, vehicle power could be limited.

Charging the battery before driving helps increase power.

DRIVING ELECTRIC VEHICLE (CONT.)

NOTICE

If this warning message is still displayed even after the ambient temperature has increased, we recommend that you have the vehicle inspected by an authorized HYUNDAI dealer.

Battery overheated! Stop safely



This warning message is displayed to protect battery and electric vehicle system when the high voltage battery temperature is too high.

Turn off the START/STOP button and stop the vehicle so that the battery temperature decreases.

Power limited



In the following cases, this warning message is displayed when the vehicle's power is limited for safety.

- When the high voltage battery is below a certain level, or voltage is decreasing.
- When the temperature of the motor or high voltage battery is too high very high.
- When there is a problem with the cooling system or a failure that may interrupt normal driving.

NOTICE

- When this warning message is displayed, do not accelerate or start the vehicle suddenly.
- When the power is limited for the safety of the high-powered parts of an electric vehicle, the warning message is displayed. Your vehicle may not be driven, or may roll back on a slope with the warning message displayed due to the limitation of vehicle power.

Stop safely and check power



This warning message is displayed when a failure occurs in the power supply system.

In this case, park the vehicle in a safe location and we recommend that you have your vehicle towed to the nearest authorized HYUNDAI dealer and have the vehicle inspected.

Check virtual engine sound system



This message is displayed when there is a problem with the Virtual Engine Sound System (VESS).

In this case, we recommend that you have the vehicle inspected by an authorized HYUNDAI dealer.

DRIVING ELECTRIC VEHICLE (CONT.)

Check electric vehicle system



This warning message is displayed when there is a problem with the electric vehicle control system.

Refrain from driving when the warning message is displayed.

In this case, we recommend that you have the vehicle inspected by an authorized HYUNDAI dealer.

Energy flow

The electric vehicle system informs the drivers its energy flow in various operating modes. While driving, the current energy flow is specified in 3 modes.

Vehicle Stop



The vehicle is stopped.
(No energy flow)

EV Propulsion

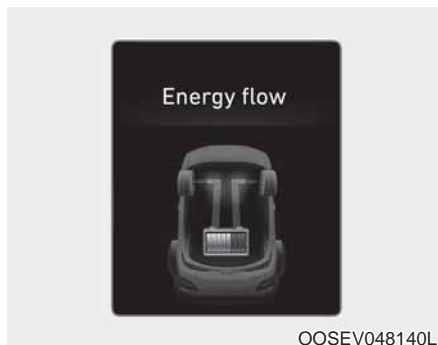

Only the motor power is used to drive the vehicle.
(Battery Wheel)

Regeneration



The high-voltage battery is charged up by the regenerative brake system.
(Wheel Battery)

Aux. Battery Saver+

The Aux. Battery Saver+ is a function that monitors the charging status of the 12 V auxiliary battery.

If the auxiliary battery level is low, the main high voltage battery charges the auxiliary battery.

i Information

The Aux. Battery Saver+ function will be ON when the vehicle is delivered. If the function is not needed, you may turn it off in the Users Settings mode on the cluster. For more information, refer to the following page.

DRIVING ELECTRIC VEHICLE (CONT.)

Mode

- Cycle Mode :

When the START/STOP button is in the OFF position with all doors, hood and tailgate closed, the Aux. Battery Saver+ periodically activates according to the auxiliary battery status.

- Automatic Mode :

When the START/STOP button is in the ON position with the charging connector plugged in, the function activates according to the auxiliary battery status to prevent overdischarge of the auxiliary battery.

i Information

- **The Aux. Battery Saver+ activates maximum of 20 minutes. If the Aux. Battery Saver+ function activates more than 10 times consecutively, in the Automatic Mode the function will stop activating, judging that there is a problem with the auxiliary battery. In this case, drive the vehicle for some period of time. The function will start activating if the auxiliary battery returns to normal.**
- **The Aux. Battery Saver+ function cannot prevent battery discharge if the auxiliary battery is damaged, worn out, used as a power supply or unauthorized electronic devices are used.**

System Setting

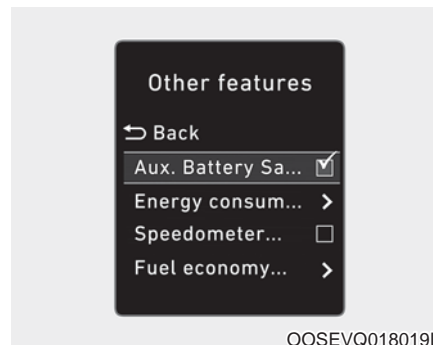

The driver can activate the Aux. Battery Saver+ function by placing the START/STOP button to the ON position and by selecting: 'User settings → Other features → Aux. Battery Saver+'

The Aux. Battery Saver+ function deactivates, when the driver cancels the system setting.

⚠ WARNING



When this function is activating the indicator lamp will illuminate and high voltage electricity will be flowing into the vehicle. Do not touch the high voltage electric wire (orange), connector, or any electrical components and devices. This may cause an electric shock and lead to injuries. Also, do not modify your vehicle in any way. This may affect your vehicle performance and lead to an accident.

Utility Mode

The high voltage battery is used instead of the 12V auxiliary battery for operating the convenient features of the vehicle. When driving is not necessary such as while camping or when stopping the vehicle for a long time, it is possible to use the electrical devices (audio, lights, etc.) for long hours.

System Setting and Activation

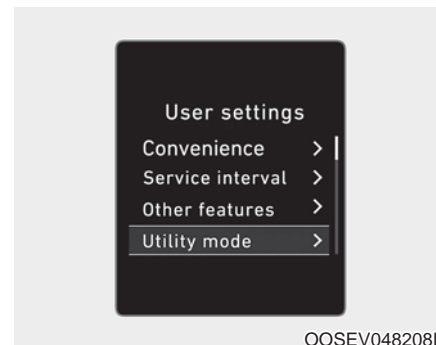

System setting



The driver can activate the Utility Mode function when the following conditions are satisfied.

- The vehicle is in the ready () mode and the gear is shifted to P (Park).
- The EPB (Electronic Parking Brake) is applied.
- 'User Settings → Utility Mode' is selected in the cluster.

DRIVING ELECTRIC VEHICLE (CONT.)

System Activation

When the system is activated:

- The  indicator will turn off and the  indicator will illuminate on the cluster.
- All electric devices are usable but the vehicle cannot be driven.
- The EPB can be cancelled by pressing the EBP switch.
- Gear cannot be shifted out of P (Park). If a shift attempt is made, a message “Shifting conditions not met” will be displayed on the cluster.

System Deactivation

The Utility Mode can be deactivated by pressing the START/STOP button to the OFF position. The function cannot be deactivated from the User Settings mode.

SAFETY PRECAUTIONS FOR ELECTRIC VEHICLE

Countermeasures for Accidents or Fire

When an accident occurs while driving the electric vehicle, turn on the hazard warning flasher, move the vehicle to a safe place, and do not let other people approach the site.

WARNING

When an accident occurs, and the high voltage battery is damaged, harmful gas and electrolytes may leak.

- Be careful not to touch the leaked liquid.
- When you suspect leakage of inflammable gas and other harmful gases, open the windows and immediately evacuate to a safe location.
- If any leaked fluid comes in contact with your eyes or skin, immediately clean the affected area thoroughly with tap water or saline solution and have doctors inspect it as soon as possible.

If the electric vehicle catches fire

If a fire occurs, evacuate to a safe place and do not let other people approach the site.

- Contact the fire department, report an electric vehicle fire, and then follow its instructions.

CAUTION

- If a fire occurs, evacuate to a safe place and wait until the firefighters arrive.
- If the lower part of the vehicle where the high voltage battery is located catches fire, large amount of water must be supplied continuously for a long time to completely extinguish the fire. It is hard to extinguish the fire without sufficient water and appropriate fire extinguishers. If you approach the vehicle carelessly, it may cause accidents, such as electric shock, and result in serious injury.

If the electric vehicle is submerged

If the electric vehicle is submerged while driving, follow the instructions below:

- Immediately turn off the vehicle and evacuate to a safe place with your key.
- Contact the emergency rescue service such as a fire department, or an authorized HYUNDAI dealer.

WARNING

Never touch the submerged electric vehicle. This may lead to an accident such as an electric shock or fire.

SAFETY PRECAUTIONS FOR ELECTRIC VEHICLE (CONT.)

⚠ WARNING

- Flatbed Towing

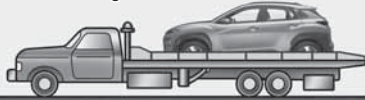

- Tires Locked Towing



Dolly

- Tires Locked Towing



Dolly

OOSEV068009

- **If towing is required, lift all four wheels off the ground and tow the vehicle. If you must tow the vehicle using only two wheels, lift the front wheels off the ground and tow the vehicle.**

⚠ WARNING



OOS067022

- **If you tow the vehicle while the front wheels are touching the ground, the vehicle motor may generate electricity and the motor components may be damaged or a fire may occur.**
- **When a vehicle fire occurs due to the battery, there is a risk of a second fire. Contact the fire department when towing the vehicle.**

Other Precautions for Electric Vehicle

- When you paint or apply heat treatment to the vehicle as a result of an accident, the performance of the high voltage battery can be reduced.

If heat treatment is required, we recommend that you contact an authorized HYUNDAI dealer.

- When you clean the motor compartment, do not use high pressure water to wash. This may cause an electric shock due to a discharge in high voltage electricity, or damage the vehicle's electric system.
- Do not use or install non-genuine parts. This may damage the electric power system.

Service Interlock Connector

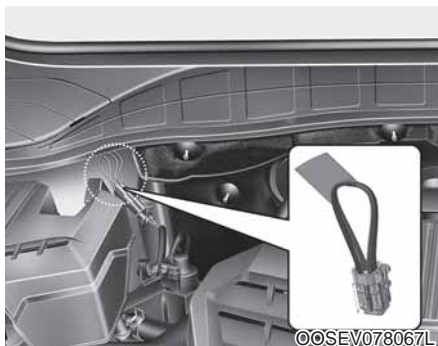

Service interlock connector is a device located inside the motor compartment to block the battery's high voltage when your vehicle is inspected at an authorized HYUNDAI dealer.

⚠ WARNING

- **Never touch the service interlock connector. This could result in serious injury or death in a collision or electric shock.**
- **If the service interlock connector requires an inspection or repair, we recommend that you contact an authorized HYUNDAI dealer.**
- **Never disconnect or cut the interlock connector except in an emergency situation. Serious problems may occur, such as the vehicle may not start.**

Service Plug (if equipped)

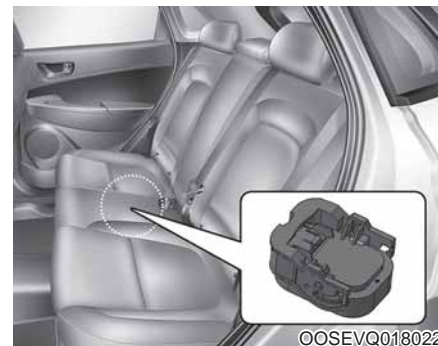

⚠ DANGER

Never touch the service plug under the rear seat.

The service plug is attached to the high voltage battery system. Touching the service plug will result in death or serious injury. Service personnel should follow procedures in service manual.

Hyundai Warranty Policy

- Hyundai new vehicle warranty 1-2
- Replacement parts warranty 1-3
- Hyundai extended warranty 1-4
- Hyundai Road Side Assistance 1-5
- Labour Free Service Coupons 1-6

HYUNDAI NEW VEHICLE WARRANTY

Hyundai Motor India Limited hereinafter called "HMIL", warrants that each new Hyundai vehicle sold shall be free from any defects in material and workmanship, under normal use and maintenance, subject to the following terms and conditions.

1. Warranty period

This warranty shall exist for a period of 36 months from the date of delivery to the first purchaser irrespective of the Mileage. However, the warranty for Hyundai vehicle being used for commercial purpose such as Taxi/Tourist operation is 36 months/100,000 kilometers from the date of delivery which soever is earlier. The warranty on **High Voltage Battery** shall exist for a period of 96 months/160,000 kms whichever is earlier from the date of delivery to the first purchaser. Both the warranties are transferable to subsequent owner for the remaining warranty period. These warranties are applicable only in India and not transferable to any other country.

2. What is covered

Except as provided in paragraph 3 hereof, our Authorized Dealers shall either repair or replace, any Hyundai genuine part that is acknowledged by HMIL to be defective in material or workmanship within the warranty period stipulated above, at no cost to the owner of the Hyundai vehicle for parts or labour. Such defective parts which have been replaced will become the property of HMIL.

3. What is not covered

This warranty shall not apply to:

- o Normal maintenance services other than the three free services, including without limitation, cleaning and polishing, minor adjustments, vehicle tuning, oil/fluid changes filters replenishment, fastener retightening, wheel balancing, wheel alignment and tyre rotation etc.
- o If the degree of degradation of the high-voltage battery is within the normal aging level according to the use of the vehicle.
- The criterion for normal aging of high-voltage battery conforms to our internal quality standards.

- o Replacement of parts as a result of normal wear and tear such as belts, brake pads and linings, filters, wiper blades, bulbs, fuses, etc.
- o Damage or failure resulting from:
 - ❖ Negligence of proper maintenance as required in this Owner's Manual and Service Booklet.
 - ❖ Misuse, abuse, accident, theft, flooding or fire.
 - ❖ Use of improper battery charger, fluids or lubricants.
 - ❖ Use of parts other than Hyundai Genuine Parts.
 - ❖ Any device and/or accessories not supplied by HMIL.
 - ❖ Modifications, alterations, tampering or improper repair.
 - ❖ Parts used in applications of which they were not designed or not approved by HMIL.
 - ❖ Slight irregularities not recognised as affecting quality or function of the vehicle or parts, such as slight noise or vibrations, or items considered characteristic of the vehicle.
 - ❖ Airborne "fallout", Industrial fall out, acid rain, hail and wind storms, or other Acts of God.

- ❖ Paint scratches, dents or similar paint or body damage.
- ❖ Action of road elements (sand, gravel, dust or road debris) which results in stone chipping of paint or glass.

Audio System, Auxillary Batteries, Wireless charger, Tyres & Tubes and originally equipped on Hyundai vehicles are warranted directly by the respective manufacturers and not by HMIL.

PARTS REPLACEMENT WARRANTY

- o Incidental or consequential damages, including without limitation, loss of time, inconvenience, loss of use of vehicle or commercial loss.

This warranty is the entire warranty given by HMIL for Hyundai vehicles and no dealer or its or his agent or employee is authorized to extend or enlarge this warranty and no dealer or its or his agent or employee is authorized to make any oral warranty on HMIL's behalf.

HMIL reserves the right to make any change in design or make any improvement on the vehicle at any

time without any obligation to make the same change on vehicles previously sold.

HMIL reserves the right for the final decision in all warranty matters.

Owner's Responsibilities

- o Proper use, maintenance and care of vehicle in accordance with the instructions contained in this Owner's Manual and Service Booklet. If the vehicle is subject to severe usage conditions, such as operation in extremely dusty, rough, more repeated short distance driving or heavy city traffic during hot weather, maintenance of vehicle should be done more frequently as mentioned in this Owner's Manual and Service Booklet.
- o Retention of maintenance service records. It may be necessary for the customer to show that the required maintenance has been performed, as specified in this Owner's Manual and Service Booklet.
- o Delivery of the vehicle during regular service business hours to any authorized Hyundai Dealer to

obtain warranty service.

- o In order to maintain the validity of this Basic Warranty, the vehicle must be serviced by Hyundai Authorized workshop in accordance to the Owner's Manual and Service Booklet.

Hyundai Motor India Limited hereinafter called "HMIL", warrants that each new Hyundai Genuine replacement part purchased from and installed by Hyundai Authorized Dealer shall be free from any defects in material or workmanship, under normal use and maintenance, subject to the following terms and conditions.

1. Warranty period

This warranty shall exist for a period of 6 months or until the vehicle has been driven for a distance of 10,000 Kilometers from the date of installation of replacement part by Hyundai Authorized Dealer, whichever occurs first.

2. What is covered

Except as provided in paragraph 3 hereof, our Authorized Dealer who had sold and installed the replacement part earlier shall either repair or replace the said Hyundai genuine part that is acknowledged by HMIL to be defective in material or workmanship within the warranty period stipulated above, at no cost to the owner of the Hyundai vehicle for parts or labour.

3. What is not covered

This warranty shall not apply to:

- o Normal maintenance services of parts such as cleaning, adjustment or replacement.
- o Parts that fail due to abuse, misuse, neglect, alteration or accident or which have been improperly lubricated or repaired.
- o Parts used in applications for which they were not designed or approved by HMIL.
- o Failure due to normal wear of parts.
- o Direct or indirect failures caused by misuse and improper maintenance of vehicle and installation of non-Hyundai parts on the vehicle.

- o Any vehicle on which the odometer reading has been altered so that mileage cannot be accurately determined.
- o Incidental or consequential damages, including without limitation, loss of time, inconvenience, loss of use of vehicle or commercial loss.

This warranty is the entire warranty given by HMIL for Hyundai replacement parts and no dealer or its or his agent or employee is authorized to extend or enlarge this warranty and no dealer or its or his agent or employee is authorized to make any oral warranty on HMIL's behalf.

HMIL reserves the right for the final decision in all warranty matters.

Owner's Responsibilities

- o Proper use, maintenance and care of the vehicle in accordance with the instructions contained in the Owner's Manual and Service Booklet.
- o Retention of maintenance service records. It may be necessary for the customer to show that the

required maintenance has been performed, as specified in this Owner's Manual and Service Booklet.

- o Retention of the customer's copy of the original repair order and its invoice/bill against which the part was replaced.
- o Delivery of the vehicle during regular service business hours to the same Hyundai Authorized Dealer who had sold and installed the replacement part.
- o In order to maintain the validity of this Parts replacement Warranty, the vehicle must be serviced by Hyundai Authorized workshop in accordance to the Owner's Manual and Service Booklet.

HYUNDAI EXTENDED WARRANTY*

HMIL offers optional paid extended warranty on selected models, in addition to the basic new vehicle warranty. For more details on Hyundai Extended Warranty please call the nearest dealer or our toll free number 1-800-11-4645

**Conditions apply*

We are pleased to introduce you to our 24 X 7 Hyundai Road Side Assistance Programme

**Our Road Side Assistance number is : 1800 102 4645 (toll free),
(0124)2564645 (call charges apply)**

Hyundai Roadside assistance is a 24 X 7 emergency support provided in the event of any mechanical/electrical breakdown and/or road traffic accident of a vehicle.

Covered Events & Benefits *

Break Down/Accident

Roadside repair or vehicle recovery in case of breakdown/road traffic accident

Tire Related

Tire Puncture – Replacement of Punctured tire with the spare tire

Battery Related

Dead Battery – Jump Start

Key Related

Locked keys, lost keys or broken vehicle keys

* Terms and Conditions apply.

Terms and Conditions

- 1) The Service is applicable for 3 years from the date of sale
- 2) The 24 X 7 Road Side Assistance is available up to a nearest Hyundai Authorised dealer workshop
- 3) The Service is applicable for a condition in which the vehicle has been immobile
- 4) Cost of parts replacement is not included, unless covered under Hyundai Warranty
- 5) Cost of repairs made to your vehicle is not included, unless it is covered under Hyundai Warranty.
- 6) For Online retail RSA & Complete TnC's, kindly visit:
<https://hyundai.awpassistance.in/>

1st FREE SERVICE COUPON

(1,200-1,500 km or within 2 months of delivery; whichever is earlier)

Customer Copy

Model Name _____

Customer's Name _____

VIN _____

Registration No. _____

Mileage _____

Delivery Date _____

Service Date _____

RO Number _____

Dealer/HASC code _____

Servicing Dealer's Stamp

Service Mgr's Signature _____

2nd FREE SERVICE COUPON

(9,000-10,000 km or within 12 months of delivery whichever is earlier)

Customer Copy

Model Name _____

Customer's Name _____

VIN _____

Registration No. _____

Mileage _____

Delivery Date _____

Service Date _____

RO Number _____

Dealer/HASC code _____

Servicing Dealer's Stamp

Service Mgr's Signature _____

3rd FREE SERVICE COUPON

(19,000-20,000 km or within 24 months of delivery whichever is earlier)

Customer Copy

Model Name _____

Customer's Name _____

VIN _____

Registration No. _____

Mileage _____

Delivery Date _____

Service Date _____

RO Number _____

Dealer/HASC code _____

Servicing Dealer's Stamp

Service Mgr's Signature _____

Free Service Coupons are valid at all Hyundai dealerships, dealer branches and Authorized service centres in India.

**For more information on vehicles service check pts. during free service period, pls refer page 5-3 "Maintenance schedule".*

CHECK LIST FOR FREE SERVICE 1500 KM - 20,000 KM

T-TEACHING I-INSPECT C-CLEAN R-REPLACE L-LUBRICATE I(IR)-INSPECT IF REQUIRED ADJUST/CORRECT

(AFTER INSPECTION, ADD, REPAIR OR REPLACE IF NECESSARY)

No.	Item Description	1st Service		2nd Service		3rd Service	
		Reqd.	Done	Reqd.	Done	Reqd.	Done
A. ENGINE BAY							
1	Battery condition & specific gravity	I		I		I	
2	Power steering fluid and leakages	-		-		-	
3	Brake fluid*	-		I		R	
4	Coolant*	-		-		I	
5	Reduction Gear Fluid	I		I		I	
B. VEHICLE ON FLOOR							
6	Wiper (wiper blade, washer fluid)	I		I		I	
7	Brake (free play & leakages)	I		I		I	
8	Fuel filler cap	-		I		I	
9	Climate control air filter*	I		R		R	
10	Check AC system (refrigerant/compressor)	I		I		I	
11	Cooling system & leakage	I		I		I	

*NOTICE

All consumables are chargeable to the customer(s).

1st Service - 1500 km/2 months
 2nd Service - 10000 km/12 months
 3rd Service - 20000 km/24 months

No.	Item Description	1st Service		2nd Service		3rd Service	
		Reqd.	Done	Reqd.	Done	Reqd.	Done
C. VEHICLE ON LIFT							
12	Steering gear rack, linkage and boots	I		I		I	
13	Exhaust system	I		I		I	
14	Front & rear suspension (linkages & ball joints)	I		I		I	
15	Driveshafts & boots	I		I		I	
16	Fluid leakages	I		I		I	
17	Front and rear wheel bearing & bushes	I(IR)		I(IR)		I(IR)	
18	Front and rear disc/drum brakes & pads	I		I		I	
19	Parking brake (disc, shoe & operation)	I		I		I	
20	Wheel Alignment & Balancing*	-		I(IR)		I(IR)	
21	Tyre pressure, condition & rotation*	I,TR		I,TR		I,TR	
22	TPMS Sensor ID writing *	-		T		T	
D. FINAL CHECKS							
23	Bolt and nuts on chassis and body	I		I		I	
24	Lubricate locks & hinges	I		L		L	
25	All electrical systems (drive belts, alternator)	I		I		I	
26	Warning lights operation & GDS system tool	I		I		I	
27	Ext & int. lights, horn & gauges	I		I		I	
28	Power window / sunroof operation (if equipped)	I		I		I	
29	All seat belt operation	I		I		I	
30	Road test	I(IR)		I(IR)		I(IR)	

*Chargeable basis

Your Vehicle at a Glance

Exterior overview (front view)	1-2
Exterior overview (rear view).....	1-3
Interior overview	1-4
Instrument panel overview	1-5
Motor compartment	1-6

EXTERIOR OVERVIEW (FRONT VIEW)



- 1. Hood.....3-33
- 2. Front lamps7-51
- 3. Tires and wheels 7-25, 8-4
- 4. Outside rearview mirror.....3-19
- 5. Sunroof.....3-28
- 6. Charging door.....3-37
- 7. Front windshield wiper blades.....7-18
- 8. Windows.....3-23

The actual shape may differ from the illustration.

OOSEV018001AU

EXTERIOR OVERVIEW (REAR VIEW)



The actual shape may differ from the illustration.

- 1. Antenna 4-3
- 2. Doors 3-9
- 3. Rear lamps 7-56
- 4. High mounted stop lamp 7-59
- 5. Tailgate 3-34
- 6. Rear view monitor 3-99
- 7. Rear window wiper blades 7-20

OOSIEV019002

INTERIOR OVERVIEW



- 1. Door lock/unlock button.....3-10
- 2. Outside rearview mirror folding switch3-21
- 3. Outside rearview mirror control switch3-19
- 4. Central door lock switch.....3-11
- 5. Power window lock switch.....3-26
- 6. Power window switches3-23
- 7. Headlight leveling device3-90
- 8. Instrument panel illumination control switch 3-39
- 9. ESC OFF button.....5-33
- 10. AUTO/LOCK mode selection button.... H18
- 11. VESS (Vehicle Engine Sound System) button H46
- 12. Hood release lever3-33
- 13. Fuse box.....7-36
- 14. Steering wheel.....3-15
- 15. Seat.....2-4

The actual shape may differ from the illustration.

OOSIEV019003

INSTRUMENT PANEL OVERVIEW



The actual shape may differ from the illustration.

1. Instrument cluster.....3-38
2. Horn.....3-17
3. Driver's front air bag.....2-50
4. START/STOP button.....5-5
5. Light control/Turn signals.....3-85
6. Wiper/Washer.....3-95
7. Infotainment system4-5
8. Hazard warning flasher6-2
9. Automatic climate control system..... 3-109
10. Passenger's front air bag2-50
11. Glove box3-126
12. Reduction gear (shift button)..... 5-10
13. Wireless cellular phone charging system3-131
14. AUX, USB and iPod® port4-2
15. Seat warmer/Air ventilation seat2-21/2-22
16. Drive mode button.....5-39
17. Heated steering wheel3-17
18. Auto hold5-27
19. Parking Distance Warning (Reverse/Forward) ON button/.....3-104
Parking Distance Warning (Reverse) OFF button.....3-100
20. EPB (Electronic Parking brake).....5-21
21. Cup holder.....3-128
22. Cruise controls5-40
23. Steering wheel audio controls/.....4-3
Bluetooth® wireless technology hands-free controls.....4-5

MOTOR COMPARTMENT

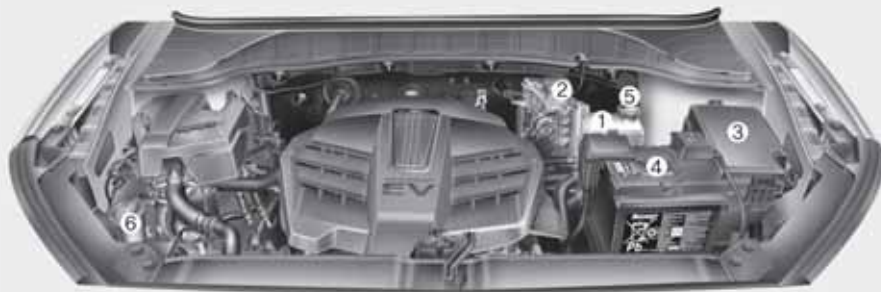

- 1. Coolant reservoir 7-13
- 2. Brake fluid reservoir 7-14
- 3. Fuse box..... 7-36
- 4. Battery (12 volt) 7-21
- 5. Coolant reservoir cap 7-13
- 6. Windshield washer fluid reservoir 7-15

The actual motor compartment in the vehicle may differ from the illustration.

O0SEV078001

Safety System of Your Vehicle

This chapter provides you with important information about how to protect yourself and your passengers. It explains how to properly use your seats and seat belts, and how your air bags work. Additionally, this chapter explains how to properly restrain infants and children in your vehicle.

Important safety precautions	3-2	Child Restraint System (CRS)	3-37
Always wear your seat belt.....	3-2	Our recommendation:Children always in the rear ...	3-37
Restrain all children.....	3-2	Selecting a Child Restraint System (CRS)	3-38
Air bag hazards	3-2	Installing a Child Restraint System (CRS).....	3-40
Driver distraction	3-2	Air bag – supplemental restraint system	3-49
Control your speed.....	3-3	Where are the air bags?	3-51
Keep your vehicle in safe condition	3-3	How does the air bags system operate?	3-56
Seats	3-4	What to expect after an air bag inflates	3-60
Safety precautions	3-5	Why didn't my air bag go off in a collision?	3-62
Front seats	3-6	SRS care.....	3-67
Rear seats.....	3-12	Additional safety precautions.....	3-68
Headrest.....	3-15	Air bag warning labels	3-68
Seat warmers and air ventilation seats.....	3-20		
Seat belts	3-23		
Seat belt safety precautions.....	3-23		
Seat belt warning light	3-24		
Seat belt restraint system	3-27		
Additional seat belt safety precautions	3-33		
Care of seat belts	3-36		

IMPORTANT SAFETY PRECAUTIONS

You will find many safety precautions and recommendations throughout this section, and throughout this manual. The safety precautions in this section are among the most important.

Always wear your seat belt

A seat belt is your best protection in all types of accidents. Air bags are designed to supplement seat belts, not replace them. So even though your vehicle is equipped with air bags, ALWAYS make sure you and your passengers wear your seat belts, and wear them properly.

Restrain all children

All children under age 13 should ride in your vehicle properly restrained in a rear seat, not the front seat. Infants and small children should be restrained in an appropriate Child Restraint System. Larger children should use a booster seat with the lap/shoulder belt until they can use the seat belt properly without a booster seat.

Air bag hazards

While air bags can save lives, they can also cause serious or fatal injuries to occupants who sit too close to them, or who are not properly restrained. Infants, young children, and short adults are at the greatest risk of being injured by an inflating air bag. Follow all instructions and warnings in this manual.

Driver distraction

Driver distraction presents a serious and potentially deadly danger, especially for inexperienced drivers. Safety should be the first concern when behind the wheel and drivers need to be aware of the wide array of potential distractions, such as drowsiness, reaching for objects, eating, personal grooming, other passengers, and using cellular phones.

Drivers can become distracted when they take their eyes and attention off the road or their hands off the wheel to focus on activities other than driving. To reduce your risk of distraction and an accident:

- ALWAYS set up your mobile devices (for example, MP3 players, phones, navigation units, etc.) when your vehicle is parked or safely stopped.
- ONLY use your mobile device when allowed by laws and conditions permit safe use. NEVER text or email while driving. Most countries have laws prohibiting drivers from texting. Some countries and cities also prohibit drivers from using handheld phones.

- NEVER let the use of a mobile device distract you from driving. You have a responsibility to your passengers and others on the road to always drive safely, with your hands on the wheel as well as your eyes and attention on the road.

Control your speed

Excessive speed is a major factor in crash injuries and deaths. Generally, the higher the speed, the greater the risk, but serious injuries can also occur at lower speeds. Never drive faster than is safe for current conditions, regardless of the maximum speed posted.

Keep your vehicle in safe condition

Having a tire blowout or a mechanical failure can be extremely hazardous. To reduce the possibility of such problems, check your tire pressures and condition frequently, and perform all regularly scheduled maintenance.

SEATS

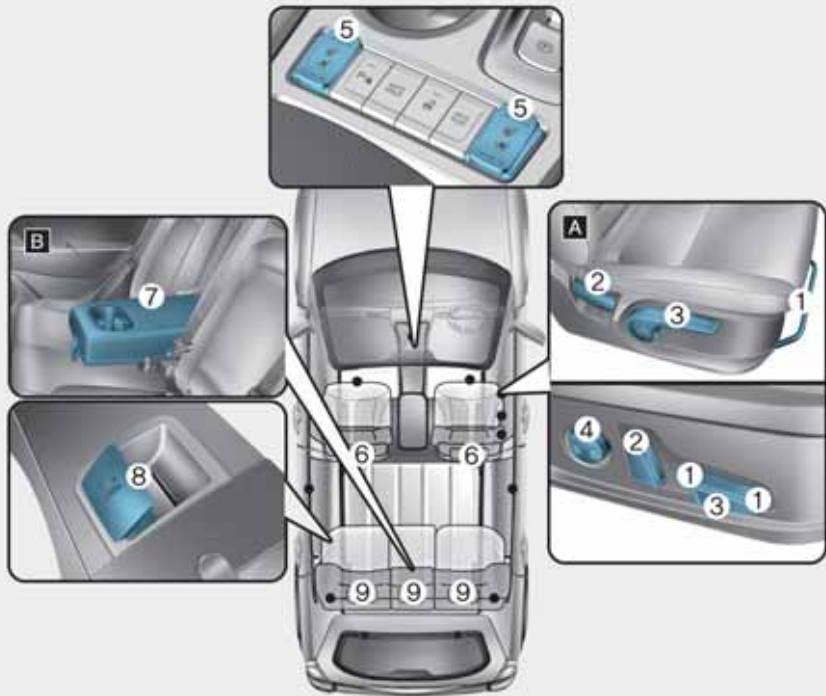

Front seat

- (1) Forward and backward
- (2) Seatback angle
- (3) Seat height*
- (4) Lumbar support (Driver's seat)*
- (5) Seat warmer */ Air ventilation seat *
- (6) Headrest

Rear seat

- (7) Armrest*
- (8) Seatback angle and folding
- (9) Headrest

* : if equipped

[A] : Front seat, [B] : Rear seat

OOSEV038026R

Safety precautions

Adjusting the seats so that you are sitting in a safe, comfortable position plays an important role in driver and passenger safety together with the seat belts and air bags in an accident.

WARNING

Do not use a cushion that reduces friction between the seat and the passenger. The passenger's hips may slide under the lap portion of the seat belt during an accident or a sudden stop.

Serious or fatal internal injuries could result because the seat belt cannot operate properly.

Air bags

You can take steps to reduce the risk of being injured by an inflating air bag. Sitting too close to an air bag greatly increases the risk of injury in the event the air bag inflates. Move your seat as far back as possible from front air bags, while still maintaining control of the vehicle.

WARNING

To reduce the risk of serious injury or death from an inflating air bag, take the following precautions:

- **Adjust the driver's seat as far to the rear as possible while maintaining the ability to control of the vehicle.**
- **Adjust the front passenger seat as far to the rear as possible.**

- **Hold the steering wheel by the rim with your hands at the 9 o'clock and 3 o'clock positions to minimize the risk of injuries to your hands and arms.**
- **NEVER place anything or anyone between the air bag.**
- **Do not allow the front passenger to place feet or legs on the dashboard to minimize the risk of leg injuries.**

Seat belts

Always fasten your seat belt before starting any trip.

At all times, passengers should sit upright and be properly restrained. Infants and small children must be restrained in appropriate Child Restraint Systems. Children who have outgrown a booster seat and adults must be restrained using the seat belts.

WARNING

Take the following precautions when adjusting your seat belt:

- **NEVER** use one seat belt for more than one occupant.
- Always position the seatback upright with the lap portion of the seat belt snug and low across the hips.
- **NEVER** allow children or small infants to ride in a passenger's lap.

- **Do not route the seat belt across your neck, across sharp edges, or reroute the shoulder strap away from your body.**
- **Do not allow the seat belt to become caught or jammed.**

Front seats

The front seat can be adjusted by using the control lever or switches located on the outside of the seat cushion. Before driving, adjust the seat to the proper position so that you can easily control the steering wheel, foot pedals and controls on the instrument panel.

WARNING

Take the following precautions when adjusting your seat:

- **NEVER** attempt to adjust the seat while the vehicle is moving. The seat could respond with unexpected movement and may cause loss of vehicle control resulting in an accident.
- Do not place anything under the front seats. Loose objects in the driver's foot area could interfere with the operation of the foot pedals, causing an accident.

- Do not allow anything to interfere with the normal position and proper locking of the seatback.
- Do not place a cigarette lighter on the floor or seat. When you operate the seat, gas may exit out of the lighter causing a fire.
- Use extreme caution when picking small objects trapped under the seats or between the seat and the center console. Your hands might be cut or injured by the sharp edges of the seat mechanism.
- If there are occupants in the rear seats, be careful while adjusting the front seat position.
- Make sure that the seat is locked in place after the adjustment. If not, the seat might move unexpectedly resulting in an accident.

⚠ CAUTION

To prevent injury:

- Do not adjust your seat while wearing your seat belt. Moving the seat cushion forward may cause strong pressure on your abdomen.
- Do not allow your hands or fingers to get caught in the seat mechanisms while the seat is moving.

Manual adjustment (if equipped)



Forward and rearward adjustment

To move the seat forward or rearward:

1. Pull up the seat slide adjustment lever and hold it.
2. Slide the seat to the position you desire.
3. Release the lever and make sure the seat is locked in place. Move forward and rearward without using the lever. If the seat moves, it is not locked properly.

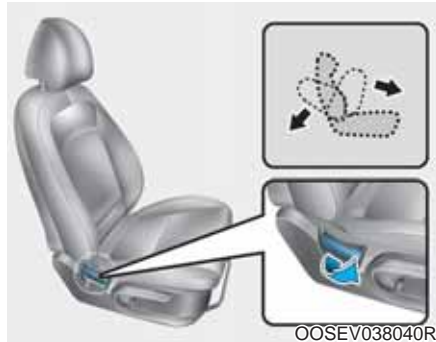

Seatback angle

To recline the seatback:

1. Lean forward slightly and lift up the seatback lever.
2. Carefully lean back on the seat and adjust the seatback to the position you desire.
3. Release the lever and make sure the seatback is locked in place. (The lever **MUST** return to its original position for the seatback to lock.)

Reclining seatback

Sitting in a reclined position when the vehicle is in motion can be dangerous. Even when buckled up, the protections of your restraint system (seat belts and/or air bags) is greatly reduced by reclining your seatback.

⚠ WARNING

NEVER ride with a reclined seatback when the vehicle is moving.

Riding with a reclined seatback increases your chance of serious or fatal injuries in the event of a collision or sudden stop.

Drivers and passengers should ALWAYS sit well back in their seats, properly belted, and with the seatbacks upright.

Seat belts must be snug against your hips and chest to work properly. When the seatback is reclined, the shoulder belt cannot do its job because it will not be snug against your chest. Instead, it will be in front of you. During an accident, you could be thrown into the seat belt, causing neck or other injuries.

The more the seatback is reclined, the greater chance the passenger's hips will slide under the lap belt or the passenger's neck will strike the shoulder belt.



Seat height (for driver's seat)

To change the height of the seat cushion:

- Push down the lever several times, to lower the seat cushion.
- Pull up the lever several times, to raise the seat cushion.

Power adjustment (if equipped)

WARNING

NEVER allow children in the vehicle unattended. Children might push the adjustment switch accidentally and get caught in the seat mechanisms while the seat is moving.

NOTICE

To prevent damage to the seats:

- Always stop adjusting the seats when the seat has been adjusted as far forward or rearward as possible.
- Do not adjust the seats longer than necessary when the vehicle is turned off. This may result in unnecessary battery drain.
- Do not operate two or more seats at the same time. This may result in an electrical malfunction.



Forward and rearward adjustment

To move the seat forward or rearward:

1. Push the control switch forward or rearward.
2. Release the switch once the seat reaches the desired position.



Seatback angle

To recline the seatback:

1. Push the control switch forward or rearward.
2. Release the switch once the seatback reaches the desired position.

Reclining seatback

Sitting in a reclined position when the vehicle is in motion can be dangerous. Even when buckled up, the protections of your restraint system (seat belts and air bags) is greatly reduced by reclining your seatback.

⚠ WARNING

NEVER ride with a reclined seatback when the vehicle is moving.

Riding with a reclined seatback increases your chance of serious or fatal injuries in the event of a collision or sudden stop.

Driver and passengers should ALWAYS sit well back in their seats, properly belted, and with the seatbacks upright.

Seat belts must be snug against your hips and chest to work properly. When the seatback is reclined, the shoulder belt cannot do its job because it will not be snug against your chest. Instead, it will be in front of you. During an accident, you could be thrown into the seat belt, causing neck or other injuries.

The more the seatback is reclined, the greater chance the passenger's hips will slide under the lap belt or the passenger's neck will strike the shoulder belt.

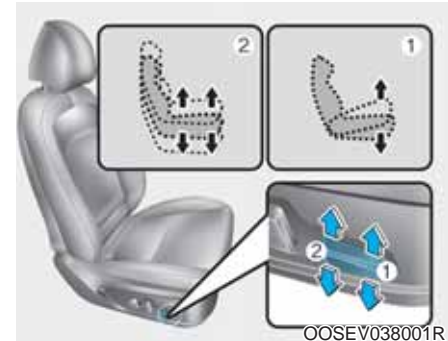

Seat cushion tilt (1, if equipped)

To change the angle of the front part of the cushion:

Push the front portion of the control switch up to raise or down to lower the front part of the seat cushion.

Release the switch once the seat reaches the desired position.

Seat height (2, if equipped)

To change the height of the seat cushion:

Push the rear portion of the control switch up to raise or down to lower the height of the seat cushion.

Release the switch once the seat reaches the desired position.



Lumbar support (for driver's seat, if equipped)

To adjust the lumbar support:

1. Press the front portion of the switch (1) to increase support or the rear portion of the switch (2) to decrease support.
2. Release the switch once it reaches the desired position.

Seatback pocket (if equipped)

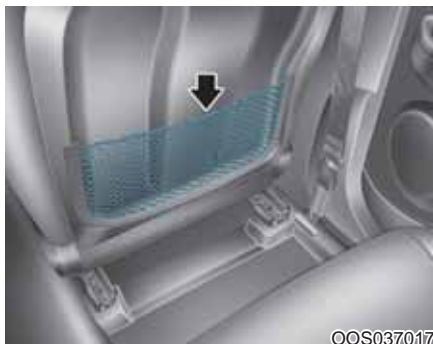

The seatback pocket is provided on the back of the front seatbacks.

CAUTION

Do not put heavy or sharp objects in the seatback pockets. In an accident they could come loose from the pocket and injure occupants.

Rear seats

Folding the rear seat

The rear seatbacks can be folded to facilitate carrying long items or to increase the luggage capacity of the vehicle.

WARNING

- Never allow passengers to sit on top of the folded down seatback while the vehicle is moving. This is not a proper seating position and no seat belts are available for use. This could result in serious injury or death in case of an accident or sudden stop.
- Objects carried on the folded down seatback should not extend higher than the top of the front seatbacks. This could allow cargo to slide forward and cause injury or damage during sudden stops.

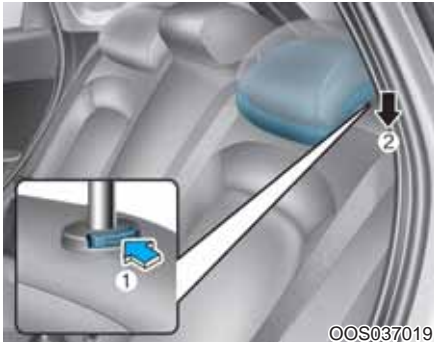

To fold down the rear seatback:

1. Set the front seatback to the upright position.
2. Lower the rear headrests down(2) pushing the adjusting button(1).



3. Locate the seatbelt toward the outboard position before folding down the seatback. If not, the seatbelt system may be interfered by the seatback.



4. Remove the belt from the guide (1) and pull up the seatback folding lever (2), then fold the seat toward the front of the vehicle.



5. To use the rear seat, lift and push the seatback rearward.

Push the seatback firmly until it clicks into place. Make sure the seatback is locked in place.

Return the belt in the guide.

WARNING

When returning the rear seatback from a folded to an upright position, hold the seatback and return it slowly. Ensure that the seatback is completely locked into its upright position by pushing on the top of the seatback. In an accident or sudden stop, the unlocked seatback could allow cargo to move forward with great force and enter the passenger compartment, which could result in serious injury or death.

WARNING

Do not place objects in the rear seats, since they cannot be properly secured and may hit vehicle occupants in a collision causing serious injury or death.

Armrest



The armrest is located in the center of the rear seat. Pull the armrest down by using the strap from the seatback to use it.

Headrest

The vehicle's front and rear seats have adjustable headrests. The headrests provide comfort for passengers, but more importantly they are designed to help protect passengers from whiplash and other neck and spinal injuries during an accident, especially in a rear impact collision.

WARNING

To help reduce the risk of serious injury or death in an accident, take the following precautions when adjusting your headrests:

- Always properly adjust the headrests for all passengers **BEFORE** starting the vehicle.
- **NEVER** let anyone ride in a seat with the headrest removed or reversed.



Adjust the headrests so the middle of the headrests is at the same height as the height of the top of the eyes.

- **NEVER** adjust the headrest position of the driver's seat when the vehicle is in motion.
- Adjust the headrest as close to the passenger's head as possible. Do not use a seat cushion that holds the body away from the seatback.
- Make sure the headrest locks into position after adjusting it.

NOTICE

To prevent damage, **NEVER** hit or pull on the headrests.

CAUTION

When there is no occupant in the rear seats, adjust the height of the headrest to the lowest position. The rear seat headrest can reduce the visibility of the rear area.

Front seat headrests

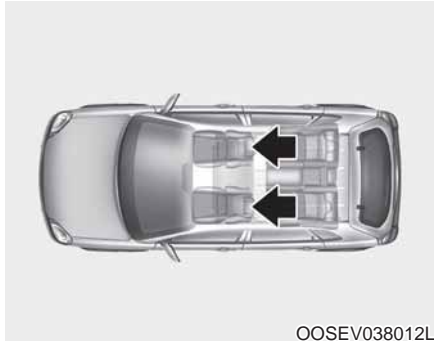

The driver's and front passenger's seats are equipped with adjustable headrests for the passengers safety and comfort.

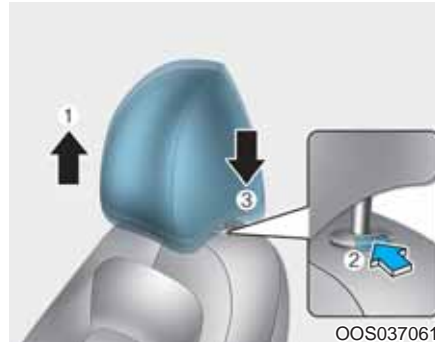

Adjusting the height up and down

To raise the headrest:

1. Pull it up to the desired position (1).

To lower the headrest:

1. Push and hold the release button (2) on the headrest support.
2. Lower the headrest to the desired position (3).

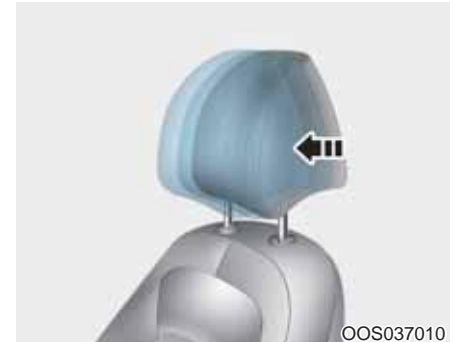

Forward and rearward adjustment (for driver's seat)

The headrest may be adjusted forward to 3 different positions by pulling the headrest forward to the desired detent. To adjust the headrest to its furthest rearwards position, pull it fully forward to the farthest position and release it.

NOTICE



If you recline the seatback towards the front with the headrest and seat cushion raised, the headrest may come in contact with the sunvisor or other parts of the vehicle.

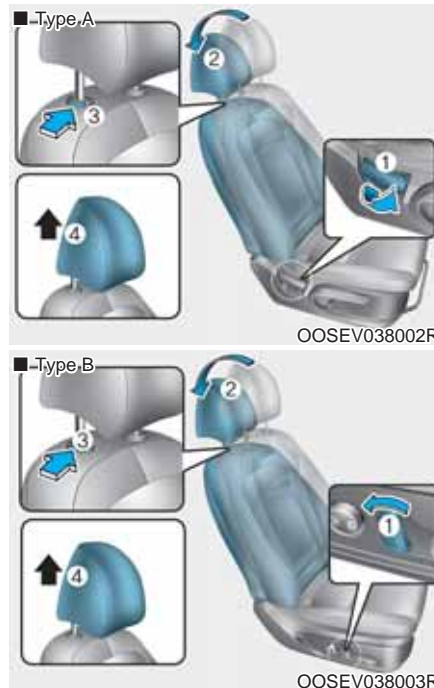

Removal/Reinstall

To remove the headrest:

1. Recline the seatback (2) with using the seatback angle lever or switch (1).

2. Raise headrest as far as it can go.
3. Press the headrest release button (3) while pulling the headrest up (4).

⚠ WARNING

NEVER allow anyone to travel in a seat with the headrest removed.

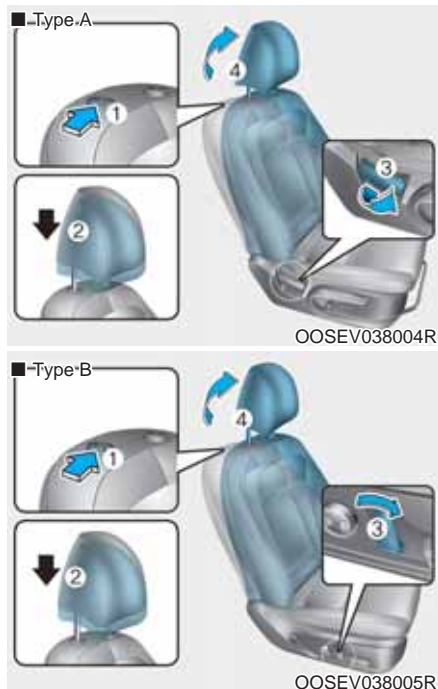

To reinstall the headrest :

1. Recline the seatback.
2. Put the headrest poles (2) into the holes while pressing the release button (1).

3. Adjust the headrest to the appropriate height.
4. Recline the seatback (4) with the seatback angle lever or switch (3).

! WARNING

Always make sure the headrest locks into position after reinstalling and adjusting it properly.

Rear seat headrests

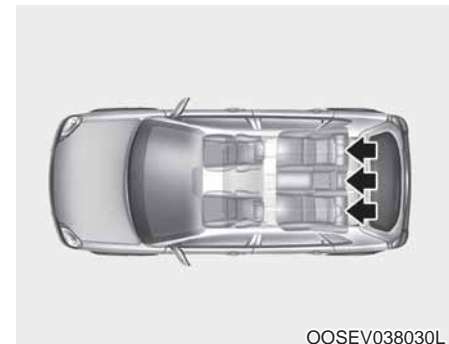

The rear seats are equipped with headrests in all the seating positions for the passenger's safety and comfort.

⚠ CAUTION

- Adjust the headrests so the middle of the headrest is at the same height as the height of the top of the eyes.
- When sitting on the rear seat, do not adjust the height of the headrest to the lowest.

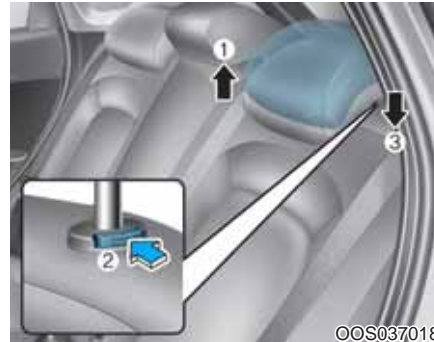
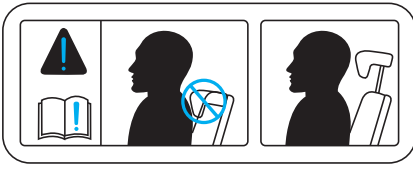

©OS037018

Adjusting the height up and down

To raise the headrest:

1. Pull it up to the desired position (1).

To lower the headrest:

1. Push and hold the release button (2) on the headrest support.
2. Lower the headrest to the desired position (3).

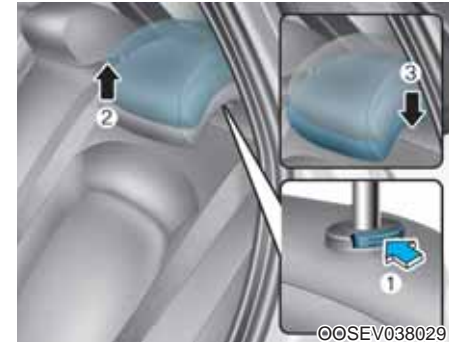

©OSEV038029

Removal/Reinstallation

To remove the headrest:

1. Raise the headrest as far as it can go.
2. Press the headrest release button (1) while pulling the headrest up (2).

To reinstall the headrest:

1. Put the headrest poles into the holes (3) while pressing the release button (1).
2. Adjust the headrest to the appropriate height.

 **WARNING**

Make sure the headrest locks in position after adjusting it to properly protect the occupants.

Seat warmers and air ventilation seats

Front seat warmers (if equipped)

Seat warmers are provided to warm the seats during cold weather.

 **WARNING**

The seat warmers can cause a **SERIOUS BURN**, even at low temperatures and especially if used for long periods of time.

Passengers must be able to feel if the seat is becoming too warm so they can turn it off, if needed.

People who cannot detect temperature change or pain to the skin should use extreme caution, especially the following types of passengers:

- Infants, children, elderly or disabled persons, or hospital outpatients.
- People with sensitive skin or who burn easily.

- Fatigued individuals.
- Intoxicated individuals.
- People taking medication that can cause drowsiness or sleepiness.

 **WARNING**

NEVER place anything on the seat that insulates against heat when the seat warmer is in operation, such as a blanket or seat cushion. This may cause the seat warmer to overheat, causing a burn or damage to the seat.

NOTICE

To prevent damage to the seat warmers and seats:

- Never use a solvent such as paint thinner, benzene, alcohol or gasoline to clean the seats.
- Do not place heavy or sharp objects on seats equipped with seat warmers.
- Do not change the seat cover. It may damage the seat warmer.

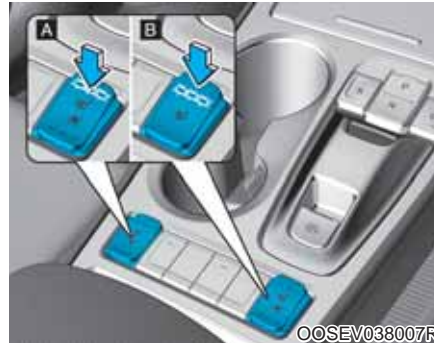

[A] : Type A, [B] : Type B

While the vehicle is ON, push either of the switches to warm the driver's seat or front passenger's seat.

During mild weather or under conditions where the operation of the seat warmer is not needed, keep the switches in the OFF position.

- Each time you push the switch, the temperature setting of the seat is changed as follows :

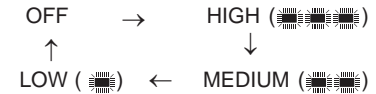

- When pressing the switch for more than 1.5 seconds with the seat warmer operating, the seat warmer will turn OFF.
- The seat warmer defaults to the OFF position whenever the START/STOP button is placed to the ON position.

i Information

With the seat warmer switch in the ON position, the heating system in the seat turns off or on automatically depending on the seat temperature.

**Front air ventilation seat
(if equipped)**



The air ventilation seats are provided to cool the front seats by blowing air through small vent holes on the surface of the seat cushions and seatbacks.

When the operation of the air ventilation seat is not needed, keep the switches in the OFF position.

While the vehicle is ON, push the switch to cool the driver's seat or the front passenger's seat (if equipped).

- Each time you push the switch, the airflow changes as follows:

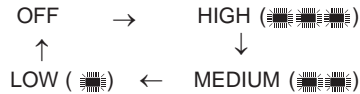

- When pressing the switch for more than 1.5 seconds with the air ventilation seat operating, the operation will turn OFF.
- The air ventilation seats defaults to the OFF position whenever the START/STOP button is placed to the ON position.

NOTICE

To prevent damage to the air ventilation seat:

- **Use the air ventilation seat ONLY when the climate control system is on. Using the air ventilation seat for prolonged periods of time with the climate control system off could cause the air ventilation seat to malfunction.**

- **Never use a solvent such as paint thinner, benzene, alcohol or gasoline to clean the seats.**
- **Avoid spilling liquids on the surface of the front seats and seatbacks; this may cause the air vent holes to become blocked and not work properly.**
- **Do not place materials such as plastic bags or newspapers under the seats. They may block the air intake causing the air vents to not work properly.**
- **Do not change the seat covers. It may damage the air ventilation seat.**
- **If the air vents do not operate, restart the vehicle. If there is no change, we recommend that you have your vehicle inspected by an authorized HYUNDAI dealer.**

SEAT BELTS

This section describes how to use the seat belts properly. It also describes some of the things not to do when using seat belts.

Seat belt safety precautions

Always fasten your seat belt and make sure all passengers have fastened their seat belts before starting any trip. Air bags (if equipped) are designed to supplement the seat belt as an additional safety device, but they are not a substitute. Most countries require all occupants of a vehicle to wear seat belts.

WARNING

Seat belts must be used by ALL passengers whenever the vehicle is moving. Take the following precautions when adjusting and wearing seat belts:

- **Children under the age of 13 should be properly restrained in the rear seats.**
- **Never allow children to ride in the front passenger seat, unless the air bag is deactivated. If a child is seated in the front passenger seat, move the seat as far back as possible. And the child must always be restrained in the seat properly.**
- **NEVER allow an infant or child to be carried on an occupant's lap.**
- **NEVER ride with the seatback reclined when the vehicle is moving.**
- **Do not allow children to share a seat or seat belt.**

- **Do not wear the shoulder belt under your arm or behind your back.**
- **Never wear a seat belt over fragile objects. If there is a sudden stop or impact, the seat belt can damage it.**
- **Do not use the seat belt if it is twisted. A twisted seat belt will not protect you properly in an accident.**
- **Do not use a seat belt if the webbing or hardware is damaged.**
- **Do not latch the seat belt into the buckles of other seats.**
- **NEVER unfasten the seat belt while driving. This may cause loss of vehicle control resulting in an accident.**
- **Make sure there is nothing in the buckle interfering with the seat belt latch mechanism, because any materials in the buckle can cause the seat belt not to be fastened securely.**

- No modifications or additions should be made by the user which will either prevent the seat belt adjusting devices from operating to remove slack, or prevent the seat belt assembly from being adjusted to remove slack.

WARNING

Damaged seat belts and seat belt assemblies will not operate properly. Always replace:

- Frayed, contaminated, or damaged webbing.
- Damaged hardware.
- The entire seat belt assembly after it has been worn in an accident, even if damage to webbing or assembly is not apparent.

Seat belt warning light

Driver's seat belt



As a reminder to the driver, the driver's seat belt warning light will illuminate for approximately 6 seconds each time you turn the Start/Stop button ON regardless of seat belt fastening.

If you start to drive without the seat belt fastened or you unfasten the seat belt when you drive under 20 km/h (12 mph) or stop, the corresponding warning light will illuminate.

If you start to drive without the seat belt fastened or you unfasten the seat belt when you drive 20 km/h (12 mph) and faster, the warning light will blink and warning chime will sound for approximately 100 seconds.

When the seat belt is unfastened during driving, the warning light will illuminate when the speed is under 20 km/h (12 mph).

When the speed is 20 km/h (12 mph) and faster, the warning light will blink and warning chime will sound for approximately 100 seconds.

Front passenger's seat belt warning



As a reminder to the front passenger, the front passenger's seat belt warning lights will illuminate for approximately 6 seconds each time you turn the Start/Stop button ON regardless of belt fastening.

If you start to drive without the seat belt fastened or you unfasten the seat belt when you drive under 20 km/h (12 mph) or stop, the corresponding warning light will illuminate.

If you start to drive without the seat belt fastened or you unfasten the seat belt when you drive 20 km/h (12 mph) and faster, the warning light will blink and warning chime will sound for approximately 100 seconds.

When the seat belt is fastened during driving, the warning light will illuminate when the speed is under 20 km/h (12 mph). When the speed is 20 km/h (12 mph) and faster, the warning light will blink and warning chime will sound for approximately 100 seconds.

⚠ WARNING

Riding in an improper position adversely affects the front passenger's seat belt warning system. It is important for the driver to instruct the passenger to be seated properly as instructed in this manual.

i Information

- You can find the front passenger's seat belt warning light on the center fascia panel.
- Although the front passenger seat is not occupied, the seat belt warning light will blink or illuminate for 6 seconds.
- The front passenger's seat belt warning may operate when luggage is placed on the front passenger seat.

Rear passenger's seat belt warning

■ Type A



■ Type B



For rear left and right side seat

As a reminder to the rear passenger, the rear passenger's seat belt warning lights will illuminate for approximately 6 seconds each time you turn the Start/Stop button ON regardless of belt fastening.

If you start to drive without the seat belt fastened or you unfasten the seat belt when you drive under 20 km/h (12 mph), the corresponding warning light will continue to illuminate until you fasten the seat belt.

If you continue to drive without the seat belt fastened or you unfasten the seat belt when you drive 20 km/h (12 mph) and faster, the seat belt warning chime will sound for approximately 35 seconds and the corresponding warning light will blink.

When the seat belt is unfastened during driving, the warning light will illuminate when the speed is under 20 km/h (12 mph).

When the speed is 20 km/h (12 mph) and faster, the warning light will blink and warning chime will sound for approximately 35 seconds.

⚠ WARNING

Riding in an improper position adversely affects the rear passenger's seat belt warning system.

It is important for the driver to instruct the passenger to properly be seated as instructed in this manual.

i Information

- You can find the rear passenger's seat belt warning light on the center fascia panel.
- Although the rear side passenger seat is not occupied, the seat belt warning light will blink or illuminate for 6 seconds.
- The rear side passenger's seat belt warning may operate when luggage, laptop or other electronic device is placed on the rear side passenger seat.

For rear center seat

As a reminder to the rear passenger, the rear passenger's seat belt warning light will illuminate for approximately 6 seconds each time you turn the Start/Stop button ON regardless of belt fastening.

If the seat belt is not fastened when the Start/Stop button is turned ON, the seat belt warning light will illuminate for approximately 70 seconds.

If you start to drive without the seat belt fastened or you unfasten the seat belt when you drive under 20 km/h (12 mph), the corresponding warning light will continue to illuminate for approximately 70 seconds.

If you continue to drive without the seat belt fastened or you unfasten the seat belt when you drive over 20 km/h (12 mph), the seat belt warning chime will sound for approximately 35 seconds and the corresponding warning light will blink.

If the rear door is opened or closed under 10 km/h (6 mph), warning light and warning sound does not work even if driving over 20 km/h (12 mph).

Seat belt restraint system

Lap/shoulder belt



To fasten your seat belt:

Pull it out of the retractor and insert the metal tab (1) into the buckle (2). There will be an audible "click" when the tab locks into the buckle.



You should place the lap belt (1) portion across your hips and the shoulder belt (2) portion across your chest.

The seat belt automatically adjusts to the proper length after the lap belt portion is adjusted manually so that it fits snugly around your hips. If you lean forward in a slow, easy motion, the belt will extend and move with you.

If there is a sudden stop or impact, the belt will lock into position. It will also lock if you try to lean forward too quickly.

NOTICE

If you are not able to smoothly pull enough of the seat belt out from the retractor, firmly pull the seat belt out and release it. After release, you will be able to pull the belt out smoothly.



⚠ WARNING

Improperly positioned seat belts may increase the risk of serious injury in an accident. Take the following precautions when adjusting the seat belt:

- **Position the lap portion of the seat belt as low as possible across your hips, not on your waist, so that it fits snugly. This allows your strong pelvic bones to absorb the force of the crash, reducing the chance of internal injuries.**
- **Position one arm under the shoulder belt and the other over the belt, as shown in the illustration.**
- **Always position the shoulder belt anchor into locked position at the appropriate height.**
- **Never position the shoulder belt across your neck or face.**

Height adjustment

You can adjust the height of the shoulder belt anchor to one of the four different positions for maximum comfort and safety.

The shoulder portion should be adjusted so it lies across your chest and midway over your shoulder nearest the door, not over your neck.

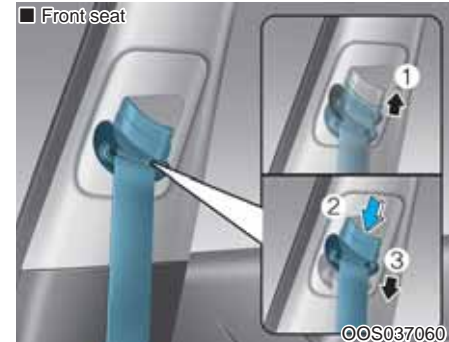

To adjust the height of the seat belt anchor, lower or raise the height adjuster into an appropriate position.

To raise the height adjuster, pull it up (1). To lower it, push it down (3) while pressing the height adjuster button (2).

Release the button to lock the anchor into position. Try sliding the height adjuster to make sure that it has locked into position.



To release your seat belt:

Press the release button (1) in the locking buckle.

When it is released, the belt should automatically draw back into the retractor. If this does not happen, check the belt to be sure it is not twisted, then try again.

**Rear center seatbelt
(3-point rear center seat belt)**



Insert the tongue plate (1) into the buckle (2) until an audible “click” is heard, indicating the latch is locked. make sure the belt is not twisted.

When using the rear center seat belt, the buckle with the “CENTER” mark must be used.

i Information

If you are not able to pull out the safety belt from the retractor, firmly pull the belt out and release it. After release, you will be able to pull the belt out smoothly.

⚠ WARNING

Make sure that the seatback is locked in place when using the rear center seat belt.

If not, the seatback may move when there is a sudden stop or collision, which could result in serious injury.

Pre-tensioner seat belt



Your vehicle is equipped with Pre-tensioner Seat Belts (Retractor Pretensioner). The purpose of the pre-tensioner is to make sure the seat belts fit tightly against the occupant's body in certain frontal collisions. The pre-tensioner seat belts may be activated in crashes where the frontal collision is severe enough, together with the air bags.

When the vehicle stops suddenly, or if the occupant tries to lean forward too quickly, the seat belt retractor will lock into position. In certain frontal collisions, the pre-tensioner will activate and pull the seat belt into tighter contact against the occupant's body.

If the system senses excessive tension on the driver or passenger's seat belt when the pre-tensioner system activates, the load limiter (if equipped) inside the retractor pre-tensioner will release some of the pressure on the affected seat belt.

⚠ WARNING

- **Always wear your seat belt and sit properly in your seat.**
- **Do not use the seat belt if it is loose or twisted. A loose or twisted seat belt will not protect you properly in an accident.**
- **Do not place anything near the buckle. This may adversely affect the buckle and cause it to function improperly.**
- **Always replace your pre-tensioners after activation or an accident.**
- **NEVER inspect, service, repair or replace the pre-tensioners by yourself. This must be done by an authorized HYUNDAI dealer.**
- **Do not hit the seat belt assemblies.**

⚠ WARNING

Do not touch the pre-tensioner seat belt assemblies for several minutes after they have been activated. When the pre-tensioner seat belt mechanism deploys during a collision, the pre-tensioner can become hot and can burn you.

⚠ CAUTION

Body work on the front area of the vehicle may damage the pre-tensioner seat belt system. Therefore, we recommend the system to be serviced by an authorized HYUNDAI dealer.

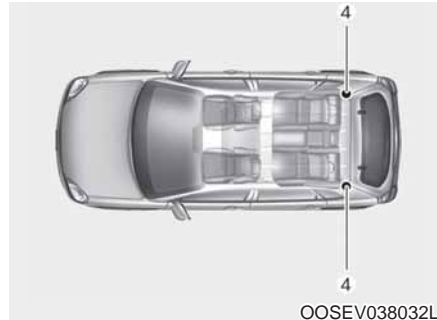
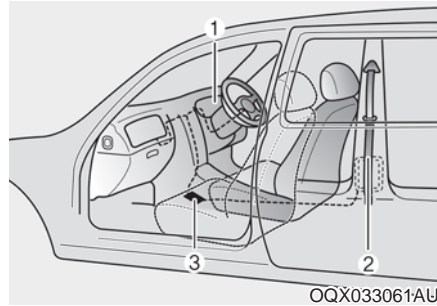

The Pre-Tensioner Seat Belt System consists mainly of the following components. Their locations are shown in the illustration above:

- (1) SRS air bag warning light
- (2) Front retractor pre-tensioner
- (3) SRS control module
- (4) Rear retractor pre-tensioner

NOTICE

The sensor that activates the SRS control module is connected with the pre-tensioner seat belts. The SRS air bag warning light on the instrument panel will illuminate for approximately 6 seconds after the START/STOP button is placed to the ON position, and then it should turn off.

If the pre-tensioner is not working properly, the warning light will illuminate even if the SRS control module is not malfunctioning. If the warning light does not illuminate when the vehicle is turned ON, stays illuminated or illuminates when the vehicle is being driven, we recommend the pre-tensioner seat belts and/or SRS air bags be inspected by an authorized HYUNDAI dealer as soon as possible.

i Information

- Both the driver's and front passenger's pre-tensioner seat belts may be activated in certain frontal or side collisions.
- The pre-tensioners will be activated even if the seat belts are not worn at the time of the collision.
- When the pre-tensioner seat belts are activated, a loud noise may be heard and fine dust, which may appear to be smoke, may be visible in the passenger compartment. These are normal operating conditions and are not hazardous.
- Although it is non-toxic, the fine dust may cause skin irritation and should not be breathed for prolonged periods. Wash all exposed skin areas thoroughly after an accident in which the pre-tensioner seat belts were activated.

Additional seat belt safety precautions

Seat belt use during pregnancy

The seat belt should always be used during pregnancy. The best way to protect your unborn child is to protect yourself by always wearing the seat belt.

Pregnant women should always wear a lap-shoulder seat belt. Place the shoulder belt across your chest, routed between your breasts and away from your neck. Place the lap belt below your belly so that it fits SNUGLY across your hips and pelvic bone, under the rounded part of the belly.

⚠ WARNING

- **Pregnant women and patients are more vulnerable to any impacts on the abdomen during an abrupt stop or accident. If you are in an accident while pregnant, consult your doctor.**
- **To reduce the risk of serious injury or death to an unborn child during an accident, pregnant women should NEVER place the lap portion of the seat belt above or over the area of the abdomen where the unborn child is located.**

Seat belt use and children

Infant and small children

Most countries have Child Restraint System laws which require children to travel in approved Child Restraint System devices, including booster seats. The age at which seat belts can be used instead of Child Restraint System differs among countries, so you should be aware of the specific requirements in your country, and where you are travelling. Infant and Child Restraint System must be properly placed and installed in a rear seat.

For more information refer to the “Child Restraint Systems” in this chapter.

⚠ WARNING

ALWAYS properly restrain infants and small children in a Child Restraint System appropriate for the child’s height and weight.

To reduce the risk of serious injury or death to a child and other passengers, NEVER hold a child in your lap or arms when the vehicle is moving. The violent forces created during an accident will tear the child from your arms and throw the child against the interior of the vehicle.

Small children are best protected from injury in an accident when properly restrained in the rear seat by a Child Restraint System that meets the requirements of the Safety Standards of your country. Before buying any Child Restraint System, make sure that it has a label certifying that it meets Safety Standard of your country. The Child Restraint System must be appropriate for your child's height and weight. Check the label on the Child Restraint System for this information. Refer to "Child Restraint Systems" in this chapter.

Larger children

Children under age 13 and who are too large for a booster seat should always occupy the rear seat and use the available lap/shoulder belts. A seat belt should lie across the upper thighs and be snug across the shoulder and chest to restrain the child safely. Check belt fit periodically. A child's squirming could put the belt out of position. In the event of an accident, children are afforded the best safety restrained by a proper Child Restraint System in the rear seats.

If a larger child over age 13 must be seated in the front seat, the child must be securely restrained by the available lap/shoulder belt and the seat should be placed in the rearmost position.

If the shoulder belt portion slightly touches the child's neck or face, try placing the child closer to the center of the vehicle. If the shoulder belt still touches their face or neck, they need to be returned to an appropriate booster seat in the rear seat.

WARNING

- **Always make sure larger children's seat belts are worn and properly adjusted.**
- **NEVER allow the shoulder belt to contact the child's neck or face.**
- **Do not allow more than one child to use a single seat belt.**

Seat belt use and injured people

A seat belt should be used when an injured person is being transported. Consult a physician for specific recommendations.

One person per belt

Two people (including children) should never attempt to use a single seat belt. This could increase the severity of injuries in case of an accident.

Do not lie down

Sitting in a reclined position when the vehicle is in motion can be dangerous. Even when buckled up, the protections of your restraint system (seat belts and/or air bags) is greatly reduced by reclining your seatback.

Seat belts must be snug against your hips and chest to work properly.

During an accident, you could be thrown into the seat belt, causing neck or other injuries.

The more the seat back is reclined, the greater the chance for the passenger's hips to slide under the lap belt or the passenger's neck to strike the shoulder belt.

⚠ WARNING

- **NEVER ride with a reclined seatback when the vehicle is moving.**
- **Riding with a reclined seatback increases your chance of serious or fatal injuries in the event of a collision or sudden stop.**
- **Driver and passengers should always sit well back in their seats with the seatbacks upright and should be belted properly.**

Care of seat belts

Seat belt systems should never be disassembled or modified. In addition, care should be taken to assure that seat belts and belt hardware are not damaged by seat hinges, doors or other abuse.

Periodic inspection

All seat belts should be inspected periodically for wear or damage of any kind. Any damaged parts should be replaced as soon as possible.

Keep belts clean and dry

Seat belts should be kept clean and dry. If belts become dirty, they can be cleaned by using a mild soap solution and warm water. Bleach, dye, strong detergents or abrasives should not be used because they may damage and weaken the fabric.

When to replace seat belts

The entire seat belt assembly or assemblies should be replaced if the vehicle has been involved in an accident. This should be done even if no damage is visible. We recommend that you consult an authorized HYUNDAI dealer.

CHILD RESTRAINT SYSTEM (CRS)

**Our recommendation:
Children always in the rear**

WARNING

Always properly restrain children in the vehicle. Children of all ages are safer when riding in the rear seats. Never place a rearward-facing Child Restraint System on the front passenger seat, unless the air bag is deactivated.

Children under age 13 should always ride in the rear seats and must always be properly restrained to minimize the risk of injury in an accident, sudden stop or sudden maneuver.

According to accident statistics, children are safer when properly restrained in the rear seats than in the front seat. Children too large for a Child Restraint System must use the seat belts provided.

Most countries have regulations which require children to travel in approved Child Restraint Systems.

The laws governing the age or height/weight restrictions at which seat belts can be used instead of Child Restraint System differs among countries, so you should be aware of the specific requirements in your country, and where you are travelling.

Child Restraint Systems must be properly installed in the vehicle seat. Always use a commercially available Child Restraint System that meets the requirements of your country.

Child Restraint System (CRS)

Infants and younger children must be restrained in an appropriate rearward-facing or forward-facing CRS that has first been properly secured to the seat of the vehicle. Read and comply with the instructions for installation and use provided by the manufacturer of the Child Restraint System.

WARNING

- **Always follow the Child Restraint System manufacturer's instructions for installation and use.**
- **Always properly restrain your child in the Child Restraint System.**
- **Do not use an infant carrier or a child safety seat that "hooks" over a seatback, it may not provide adequate protection in an accident.**
- **After an accident, we recommend a HYUNDAI dealer to check the Child Restraint System, seat belts, ISOFIX anchorages and top-tether anchorages.**

Selecting a Child Restraint System (CRS)

When selecting a Child Restraint System for your child, always:

- Make sure the Child Restraint System has a label certifying that it meets applicable Safety Standards of your country.

A Child Restraint System may only be installed if it was approved in accordance with the requirements of ECE-R44 or ECE-R129.

- Select a Child Restraint System based on your child's height and weight. The required label or the instructions for use typically provide this information.
- Select a Child Restraint System that fits the vehicle seating position where it will be used.
- Read and comply with the warnings and instructions for installation and use provided with the Child Restraint System.

Child Restraint System types

There are three main types of Child Restraint Systems: rearward-facing, forward-facing and booster Child Restraint Systems.

They are classified according to the child's age, height and weight.



Rearward-facing Child Restraint System

A rearward-facing Child Restraint System provides restraint with the seating surface against the back of the child. The harness system holds the child in place, and in an accident, acts to keep the child positioned in the Child Restraint Systems and reduce the stress to the fragile neck and spinal cord.

All children under the age of one year must always ride in a rearward-facing Child Restraint System. There are different types of rearward-facing Child Restraint Systems: infant-only Child Restraint Systems can only be used rearward-facing. Convertible and 3-in-1 Child Restraint Systems typically have higher height and weight limits for the rearward-facing position, allowing you to keep your child rearward-facing for a longer period of time.

Keep using Child Restraint Systems in the rearward-facing position as long as children fit within the height and weight limits allowed by the Child Restraint System's manufacturer.



Forward-facing Child Restraint System

A forward-facing Child Restraint System provides restraint for the child's body with a harness. Keep children in a forward-facing Child Restraint System with a harness until they reach the top height or weight limit allowed by your Child Restraint System's manufacturer.

Once your child outgrows the forward-facing Child Restraint System, your child is ready for a booster seat.

Booster seats

A booster seat is a Child Restraint System designed to improve the fit of the vehicle's seat belt system. A booster seat positions the seat belt so that it fits properly over the stronger parts of your child's body. Keep your children in booster seats until they are big enough to fit in a seat belt properly.

For a seat belt to fit properly, the lap belt must lie comfortable across the upper thighs, not the stomach. The shoulder belt should lie comfortable across the shoulder and chest and not across the neck or face. Children under age 13 must always be properly restrained to minimize the risk of injury in an accident, sudden stop or sudden maneuver.

Installing a Child Restraint System (CRS)

WARNING

Before installing your Child Restraint System always:

Read and follow the instructions provided by the manufacturer of the Child Restraint System.

Failure to follow all warnings and instructions could increase the risk of the SERIOUS INJURY or DEATH if an accident occurs.

WARNING

If the vehicle headrest prevents proper installation of a Child Restraint System, the headrest of the respective seating position shall be readjusted or entirely removed.

After selecting a proper Child Restraint System for your child and checking that the Child Restraint System fits properly on the seating position, there are three general steps for a proper installation:

- **Properly secure the Child Restraint System to the vehicle.** All Child Restraint Systems must be secured to the vehicle with the lap belt or lap part of a lap/shoulder belt or with the ISOFIX top-tether and/or ISOFIX anchorage and/or with the support leg.
- **Make sure the Child Restraint System is firmly secured.** After installing a Child Restraint System to the vehicle, push and pull the seat forward and from side-to-side to verify that it is securely attached to the seat. A Child Restraint System secured with a seat belt should be installed as firmly as possible. However, some side-to-side movement can be expected.

When installing a Child Restraint System, adjust the vehicle seat and seatback (up and down, forward and rearward) so that your child fits in the Child Restraint System in a comfortable manner.

- **Secure the child in the Child Restraint System.** Make sure the child is properly strapped in the Child Restraint System according to the Child Restraint System manufacturer's instructions.

CAUTION

A Child Restraint System in a closed vehicle can become very hot. To prevent burns, check the seating surface and buckles before placing your child in the Child Restraint System.

Suitability of each seating position for belted & ISOFIX Child Restraint Systems according to UN regulations (Information for vehicle users and CRS manufacturers)

- Yes : Suitable for fitment of the designated category of CRS
- No : Not suitable for fitment of the designated category of CRS
- "-" : Not applicable
- The table is based on LHD vehicle. Except for the front passenger seat, the table is valid for RHD vehicle. For RHD vehicle front passenger seat, please use information for the seating position number 3.

CRS categories		Seating positions						Seating position
		1	2	3	4	5	6	
Universal belted CRS		-	-	Yes ¹⁾ F, R	Yes F, R	Yes ²⁾ F, R	Yes F, R	F : Forward facing R : Rearward facing 
i-size CRS		-	-	No	Yes F, R	No	Yes F, R	
ISOFIX infant CRS (i.e. CRS for a baby)	ISOFIX (R1)	-	-	No	Yes R	No	Yes R	
Carry cot (ISOFIX lateral facing CRS)	ISOFIX (L1,L2)	-	-	No	No	No	No	
ISOFIX toddler CRS - small	ISOFIX (F2,F2X, R2X)	-	-	No	Yes F, R	No	Yes F, R	
ISOFIX toddler CRS – large* (* : not booster seats)	ISOFIX (F3, R3)	-	-	No	Yes ³⁾ F, R	No	Yes ³⁾ F, R	
Booster Seat – reduced Width	ISO CRF : B2	-	-	No	Yes	No	Yes	
Booster Seat – full Width	ISO CRF : B3	-	-	No	No	No	No	

OOSEV038035L

Seat number	Position in the vehicle	Seat number	Position in the vehicle
1	Front left	4	2 nd row left
2	Front center	5	2 nd row center
3	Front right	6	2 nd row right

Note¹) : You should adjust seatback or seat pumping(if equipped) properly.

Note²) : The seating position(number 5) is not suitable for fitment of child restraint system with support leg.

Note³) : For fitment of ISOFIX toddler's rearward facing large CRS

- Driver's seat : Seat pumping should be adjusted to appropriate height.

- Front passenger seat : Seat sliding should be adjusted to appropriate position.

✳ Never place a rearward facing Child Restraint System on the front passenger seat, unless the passenger air bag is deactivated.

✳ For semi-universal or vehicle specific CRS (ISOFIX or belted CRS), see the vehicle list provided in the manual of CRS.

✳ It is recommended to remove the head restraint, when CRS is unstable due to head restraint

ISOFIX anchorage and top-tether anchorage (ISOFIX anchorage system) for children

The ISOFIX system holds a Child Restraint System during driving and in an accident. This system is designed to make installation of the Child Restraint System easier and reduce the possibility of improperly installing your Child Restraint System. The ISOFIX system uses anchors in the vehicle and attachments on the Child Restraint System. The ISOFIX system eliminates the need to use seat belts to secure the Child Restraint System to the rear seats.

ISOFIX anchorages are metal bars built into the vehicle. There are two lower anchors for each ISOFIX seating position that will accommodate a Child Restraint System with lower attachments.

To use the ISOFIX system in your vehicle, you must have a Child Restraint System with ISOFIX attachments.

The Child Restraint System manufacturer will provide you with instructions on how to use the Child Restraint System with its attachments for the ISOFIX anchorages.

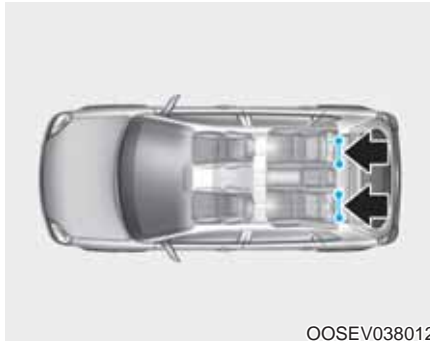

ISOFIX anchorages have been provided in the left and right outboard rear seating positions. Their locations are shown in the illustration.

⚠ WARNING

Do not attempt to install a Child Restraint System using ISOFIX anchorages in the rear center seating position. There are no ISOFIX anchorages provided for this seat. Using the outboard seat anchorages, for the CRS installation on the rear center seating position, can damage the anchorages.



[A] : ISOFIX Anchorage Position Indicator,
[B] : ISOFIX Anchorage

ISOFIX anchorages are located between the seatback and the seat cushion of the rear seat left and right outboard seating positions, indicated by the symbols .

Securing a Child Restraint System with the "ISOFIX Anchorage System"

To install an ISOFIX-compatible Child Restraint System in either of the rear outboard seating positions:

1. Move the seat belt buckle away from the ISOFIX anchorages.
2. Move any other objects away from the anchorages that could prevent a secure connection between the Child Restraint System and the ISOFIX anchorages.
3. Place the Child Restraint System on the vehicle seat, then attach the seat to the ISOFIX anchorages according to the instructions provided by the Child Restraint System manufacturer.
4. Follow the instructions of the Child Restraint System's manufacturer for proper installation and connection of the ISOFIX attachments on the Child Restraint System to the ISOFIX anchorages.

⚠ WARNING

Take the following precautions when using the ISOFIX system:

- Read and follow all installation instructions provided with your Child Restraint System.
- To prevent the child from reaching and taking hold of unretracted seat belts, buckle all unused rear seat belts and retract the seat belt webbing behind the child. Children can be strangled if a shoulder belt becomes wrapped around their neck and the seat belt tightens.
- **NEVER** attach more than one Child Restraint System to a single anchorage. This could cause the anchor or attachment to come loose or break.
- Always have the ISOFIX system inspected by your dealer after an accident. An accident can damage the ISOFIX system and may not properly secure the Child Restraint System.

Securing a Child Restraint System seat with “Top-tether Anchorage” system



Top-tether anchorages for Child Restraint Systems are located on the rear of the seatbacks.

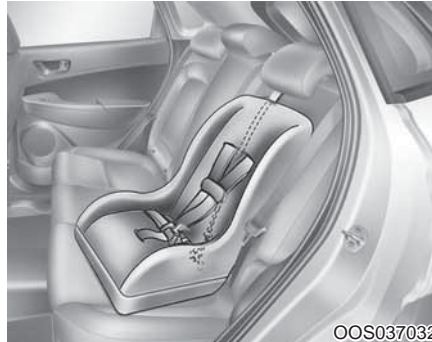

1. Route the Child Restraint System top-tether strap over the seatback. Placing the top tether strap, follow the instructions of the Child Restraint System manufacturer.
2. Connect the top-tether strap to the top-tether anchorage, then tighten the top-tether strap according to the instructions of your Child Restraint System's manufacturer to firmly attach the Child Restraint System to the seat.

⚠ WARNING

Take the following precautions when installing the top-tether:

- Read and follow all installation instructions provided with your Child Restraint System.
- **NEVER** attach more than one Child Restraint System to a single ISOFIX top-tether anchorage. This could cause the anchorage or attachment to come loose or break.
- **Do not attach the top-tether to anything other than the correct top-tether anchorage. It may not work properly if attached to something else.**
- **Child Restraint System anchorages are designed to withstand only those loads imposed by correctly fitted Child Restraint System.**

Do not use them for adult seat belts, harnesses, or for attaching other items or equipment to the vehicle.

Securing a Child Restraint System with a lap/shoulder belt

When not using the ISOFIX system, all Child Restraint Systems must be secured to a rear seat with the lap part of a lap/shoulder belt.

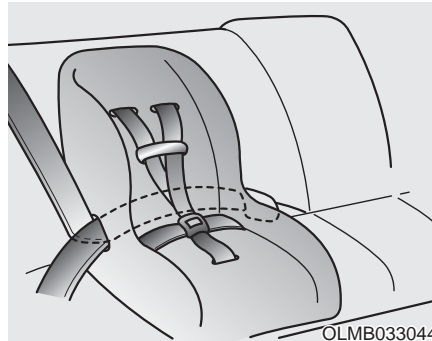

Installing a Child Restraint System with a lap/shoulder belt

To install a Child Restraint System on the rear seats, do the following:

1. Place the Child Restraint System on a rear seat and route the lap/shoulder belt around or through the Child Restraint System, following the Child Restraint System manufacturer's instructions.



2. Make sure to insert the belt into the guide (1) and check that the seat belt is not twisted.

***i* Information**

When using the rear center seat belt, you should also refer to the “Rear Center Seat Belt” in this chapter.

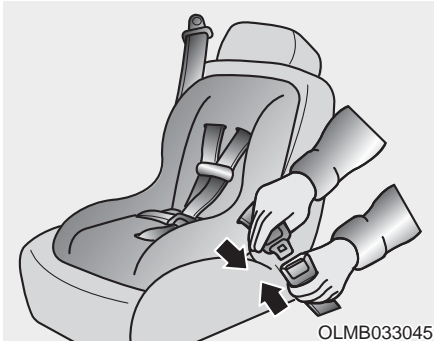

3. Fasten the lap/shoulder belt latch into the buckle. Listen for the distinct “click” sound.

i Information

Position the release button so that it is easy to access in case of an emergency.



4. Remove as much slack from the belt as possible by pushing down on the Child Restraint System while feeding the shoulder belt back into the retractor.
5. Push and pull on the Child Restraint System to confirm that the seat belt is holding it firmly in place.

If your Child Restraint System manufacturer recommends the use of a top-tether with the lap/shoulder belt, see page 2-47.

To remove the Child Restraint System, press the release button on the buckle and then pull the lap/shoulder belt out of the Child Restraint System and allow the seat belt to retract fully.

Child Seat Restraint suitability for seat position using the seat belt

Use child safety seats that have been officially approved and are appropriate for your children. When using the child safety seats, refer to following table:

Mass Group	Co-Driver	2nd Row LH	2nd Row RH	2nd Row Center	Intermediate Centre
Group 0 (up to 10kg)	X	U	U	U	-
Group 0+ (up to 13kg)	X	U	U	U	-
Group I (9 to 18kg)	UF	U	U	U	-
Group II (15 to 25kg)	UF	U	U	U	-
Group III (22 to 36kg)	UF	U	U	U	-

U = Suitable for “Universal” category Child Restraints Systems approved for use in mass group.

UF = Suitable for forward facing “universal” category restraints for use in this mass group.

X = Seat position not suitable for children in this mass group.

LF - Left Hand; RH - Right Hand

Remarks: Front LH seat upright. Rearmost position. Seatbelt shoulder anchorage to lowest position.

AIR BAG – SUPPLEMENTAL RESTRAINT SYSTEM

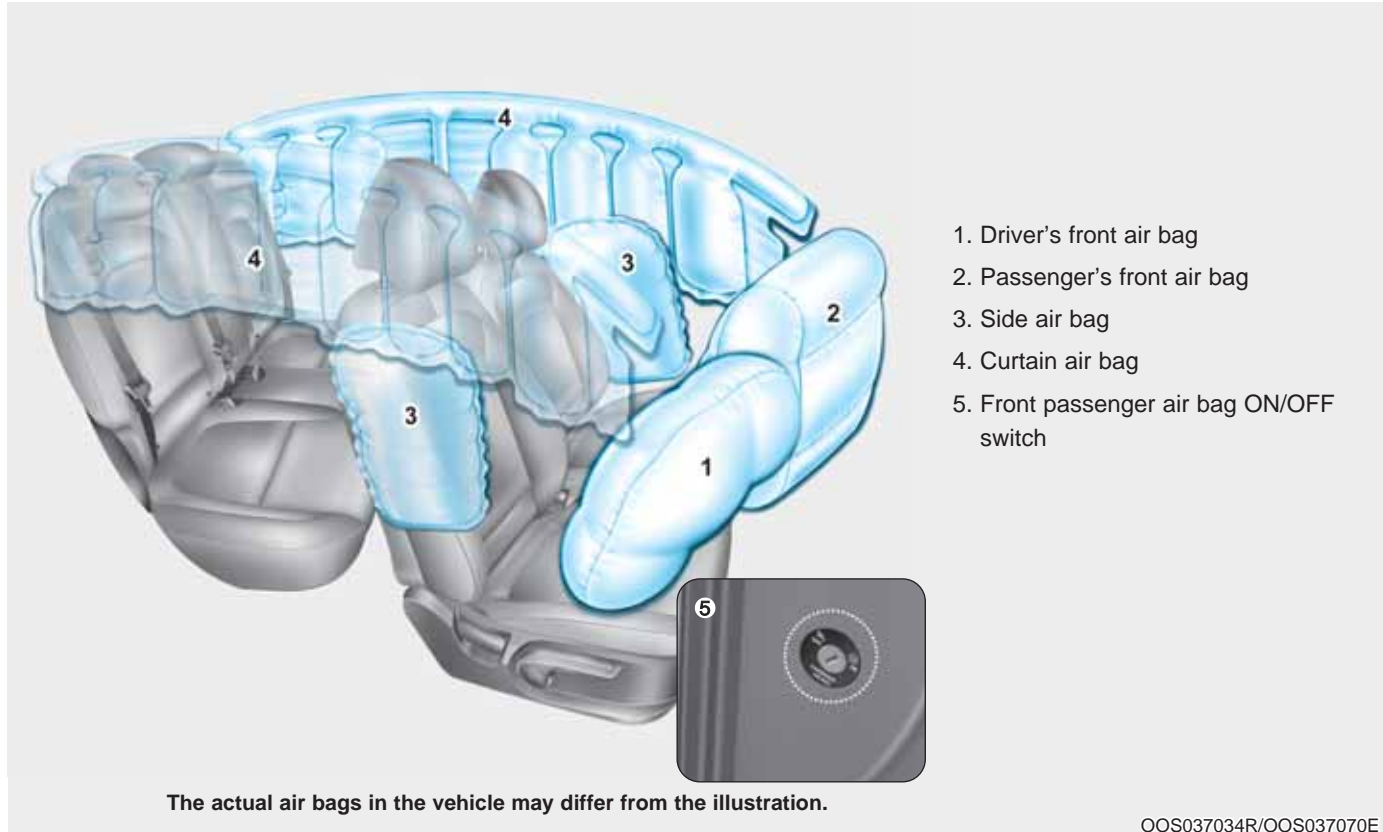

This vehicle is equipped with a Supplemental Air Bag System for the driver's seat and front passenger's seats.

The front air bags are designed to supplement the three-point seat belts. For these air bags to provide protection, the seat belts must be worn at all times when driving.

You can be severely injured or killed in an accident if you are not wearing a seat belt. Air bags are designed to supplement seat belts, but do not replace them. Also, air bags are not designed to deploy in every collision. In some accidents, the seat belts are the only restraint protecting you.

WARNING

AIR BAG SAFETY PRECAUTIONS

ALWAYS use seat belts and Child Restraint Systems - every trip, every time, everyone! Even with air bags, you can be seriously injured or killed in a collision if you are improperly belted or not wearing your seat belt when the air bag inflates.

NEVER place a child in any Child Restraint System or booster seat in the front passenger seat, unless the air bag is deactivated.

An inflating air bag could forcefully strike the infant or child causing serious or fatal injuries.

ABC - Always Buckle Children under age 13 in the back seat. It is the safest place for children of any age to ride. If a child age 13 or older must be seated in the front seat, he or she must be properly belted and the seat should be moved as far back as possible.

All occupants should sit upright with the seatback in an upright position, centered on the seat cushion with their seat belt on, legs comfortably extended and their feet on the floor until the vehicle is parked and the vehicle is turned off. If an occupant is out of position during an accident, the rapidly deploying air bag may forcefully contact the occupant causing serious or fatal injuries.

You and your passengers should never sit or lean unnecessarily close to the air bags or lean against the door or center console.

Move your seat as far back as possible from front air bags, while still maintaining control of the vehicle.

Where are the air bags?

Driver's and passenger's front air bags



Your vehicle is equipped with a Supplemental Restraint System (SRS) and lap/shoulder belts at both the driver and passenger seating positions.

The SRS consists of air bags which are located in the center of the steering wheel, and the passenger's side front panel pad above the glove box.

The purpose of the SRS is to provide the vehicle's driver and front passengers with additional protection than that offered by the seat belt system alone in case of a frontal impact of sufficient severity.

⚠ WARNING

To reduce the risk of serious injury or death from inflating front air bags, take the following precautions:

- Seat belts must be worn at all times to help keep occupants positioned properly.
- Move your seat as far back as possible from front air bags, while still maintaining control of the vehicle.
- Never lean against the door or center console.
- Do not allow the front passenger to place their feet or legs on the dashboard.

- No objects (such as crash pad cover, cellular phone holder, cup holder, air fresheners or stickers) should be placed over or near the air bag modules on the steering wheel, instrument panel, windshield glass, and the front passenger's panel above the glove box. Such objects could cause harm if the vehicle is in a crash severe enough to cause the air bags to deploy.
- Do not attach any objects on front windshield and inside mirror.



Passenger's front air bag ON/OFF switch (if equipped)

The purpose of the switch is to disable the passenger's front air bag in order to transport occupants who are at increased risk for air bag-related injury due to age, size, or medical condition.



To deactivate the passenger's front air bag:

Insert the key or a similar rigid device into the passenger's front air bag ON/OFF switch and turn it to the OFF position. The passenger air bag OFF indicator (⊗) will illuminate and stay on until the passenger's front air bag is reactivated.



To reactivate the passenger's front air bag:

Insert the key or a similar rigid device into the passenger's front air bag ON/OFF switch and turn it to the ON position. The passenger air bag ON indicator (⊗) will illuminate and stay on for 60 seconds.

i Information

The passenger's front air bag ON/OFF indicator illuminates for about 4 seconds after the START/STOP button is placed in the ON position.

⚠ WARNING

Never allow an adult passenger to ride in the front passenger seat when the passenger air bag OFF indicator is illuminated. During a collision, the air bag will not inflate if the indicator is illuminated. Turn on the passenger's front air bag or have your passenger move to the rear seat.

⚠ WARNING

If the passenger's front air bag ON/OFF switch malfunctions, the following conditions may occur:

- The air bag warning light (⚠) on the instrument panel will illuminate.
- The passenger air bag OFF indicator (⊗) will not illuminate and the ON indicator (⊗) will come on and go off after approximately 60 seconds. The passenger's front air bag will inflate in a frontal impact even though the passenger's front air bag ON/OFF switch is set to the OFF position.
- We recommend that an authorized HYUNDAI dealer inspect the passenger's front air bag ON/OFF switch and the SRS air bag system as soon as possible.

Side air bags



Your vehicle is equipped with a side air bag in each front seat.

The purpose of the air bag is to provide the vehicle's driver and the front passenger with additional protection than that offered by the seat belt alone.

The side air bags are designed to deploy during certain side impact collisions, depending on the crash severity.

The side air bags are not designed to deploy in all side impact situations.

WARNING

To reduce the risk of serious injury or death from an inflating side air bag, take the following precautions:

- Seat belts must be worn at all times to help keep occupants positioned properly.
- Do not allow passengers to lean their heads or bodies onto doors, put their arms on the doors, stretch their arms out of the window, or place objects between the doors and seats.

- **Hold the steering wheel at the 9 o'clock and 3 o'clock positions, to minimize the risk of injuries to your hands and arms.**
- **Do not use any accessory seat covers. This could reduce or prevent the effectiveness of the system.**
- **Do not hang other objects except clothes on the clothes hanger. In an accident it may cause vehicle damage or personal injury especially when airbag is inflated.**
- **Do not place any objects over the air bag or between the air bag and yourself. Also, do not attach any objects around the area the air bag inflates such as the door, side door glass, front and rear pillar.**
- **Do not place any objects between the door and the seat. They may become dangerous projectiles if the side air bag inflates.**

- Do not install any accessories on the side or near the side air bags.
- Do not put any objects between the side airbag label and seat cushion. It could cause harm if the vehicle is in a crash severe enough to cause the air bags to deploy.
- Do not cause impact to the doors when the START/STOP button is in the ON position or this may cause the side air bags to inflate.
- If the seat or seat cover is damaged, we recommend that the system be serviced by an authorized HYUNDAI dealer.

Curtain air bags



Curtain air bags are located along both sides of the roof rails above the front and rear doors.

They are designed to help protect the heads of the front seat occupants and the rear outboard seat occupants in certain side impact collisions.

The curtain air bags are designed to deploy during certain side impact collisions, depending on the crash severity.

The curtain air bags are not designed to deploy in all side impact situations.

⚠ WARNING

To reduce the risk of serious injury or death from an inflating curtain air bags, take the following precautions:

- All seat occupants must wear seat belts at all times to help keep occupants positioned properly.
- Properly secure Child Restraint System as far away from the door as possible.

- Do not place any objects over the air bag. Also, do not attach any objects around the area the air bag inflates such as the door, side door glass, front and rear pillar, roof side rail.
- Do not hang other objects except clothes, especially hard or breakable objects on the clothes hanger. In an accident, it may cause vehicle damage or personal injury.
- Do not allow passengers to lean their heads or bodies onto doors, put their arms on the doors, stretch their arms out of the window, or place objects between the doors and seats.
- Do not attempt to open or repair the side curtain air bags yourself. If necessary, we recommend that the air bag be inspected by an authorized HYUNDAI dealer.

How does the air bags system operate?

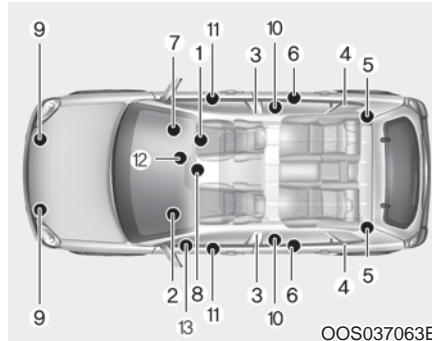

The SRS consists of the following components:

- (1) Driver's front air bag module
- (2) Passenger's front air bag module
- (3) Side air bag modules
- (4) Curtain air bag modules
- (5) Rear retractor pre-tensioner assemblies
- (6) Front retractor pre-tensioner
- (7) Air bag warning light
- (8) SRS control module (SRSCM)
- (9) Front impact sensors

- (10) Side impact sensors
- (11) Side pressure sensors
- (12) Passenger's front air bag ON/OFF indicator (front passenger's seat only)
- (13) Passenger's front air bag ON/OFF switch

The SRSCM continually monitors all SRS components while the START/STOP button is ON to determine if a crash impact is severe enough to require air bag deployment or pre-tensioner seat belt deployment.



SRS warning light

The SRS (Supplement Restraint System) air bag warning light on the instrument panel displays the air bag symbol depicted in the illustration. The system checks the air bag electrical system for malfunctions. The light indicates that there is a potential problem with your air bag system.

WARNING

If your SRS malfunctions, the air bag may not inflate properly during an accident, increasing the risk of serious injury or death.

If any of the following conditions occur, your SRS is malfunctioning:

- **The light does not turn on for approximately six seconds when the START/STOP button is in the ON position.**
- **The light stays on after illuminating for approximately six seconds.**
- **The light comes on while the vehicle is in motion.**
- **The light blinks when the vehicle is running.**

We recommend that an authorized HYUNDAI dealer inspect the SRS as soon as possible if any of these conditions occur.

During a moderate to severe frontal collision, sensors will detect the vehicle's rapid deceleration. If the rate of deceleration is high enough, the control unit will inflate the front air bags, at the time and with the force needed.

The front air bags help protect the driver and front passenger by responding to frontal impacts in which seat belts alone cannot provide adequate restraint. When needed, the side air bags help provide protection in the event of a side impact by supporting the side upper body area.

- Air bags are activated (able to inflate if necessary) only when the START/STOP button is in the ON position.
- Air bags inflate in the event of certain frontal or side collisions to help protect the occupants from serious physical injury.

- There is no single speed at which the air bags will inflate. Generally, air bags are designed to inflate based upon the severity of a collision and its direction. These two factors determine whether the sensors produce an electronic deployment/inflation signal.
- The front air bags will completely inflate and deflate in an instant. It is virtually impossible for you to see the air bags inflate during an accident. It is much more likely that you will simply see the deflated air bags hanging out of their storage compartments after the collision.

- To help provide protection, the air bags must inflate rapidly. The speed of air bag inflation is a consequence of extremely short time in which to inflate the air bag between the occupant and the vehicle structures before the occupant impacts those structures. This speed of inflation reduces the risk of serious or life-threatening injuries and is thus a necessary part of air bag design.

However, the rapid air bag inflation can also cause injuries which can include facial abrasions, bruises and broken bones because the inflation speed also causes the air bags to expand with a great deal of force.

- There are even circumstances under which contact with the air bag can cause fatal injuries, especially if the occupant is positioned excessively close to the air bag.

You can take steps to reduce the risk of being injured by an inflating air bag. The greatest risk is sitting too close to the air bag. An air bag needs space to inflate. It is recommended that drivers sit as far as possible between the center of the steering wheel and the chest while still maintaining control of the vehicle.



When the SRSCM detects a sufficiently severe impact to the front of the vehicle, it will automatically deploy the front air bags.



Upon deployment, tear seams molded directly into the pad covers will separate under pressure from the expansion of the air bags. Further opening of the covers allows full inflation of the air bags.

A fully inflated air bag, in combination with a properly worn seat belt, slows the driver's or the front passenger's forward motion, reducing the risk of head and chest injury.



After complete inflation, the air bag immediately starts deflating, enabling the driver to maintain forward visibility and the ability to steer or operate other controls.

 **WARNING**

To prevent objects from becoming dangerous projectiles when the passenger's air bag inflates:

- **Do not install or place any objects (drink holder, CD holder, stickers, etc.) on the front passenger's panel above the glove box where the passenger's air bag is located.**
- **Do not install a container of liquid air freshener near the instrument cluster or on the instrument panel surface.**

What to expect after an air bag inflates

After a frontal or side air bag inflates, it will deflate very quickly. Air bag inflation will not prevent the driver from seeing out of the windshield or being able to steer. Curtain air bags may remain partially inflated for some time after they deploy.

 **WARNING**

After an air bag inflates, take the following precautions:

- **Open your windows and doors as soon as possible after impact to reduce prolonged exposure to the smoke and powder released by the inflating air bag.**
- **Do not touch the air bag storage area's internal components immediately after an air bag has inflated. The parts that come into contact with an inflating air bag may be very hot.**
- **Always wash exposed skin areas thoroughly with cold water and mild soap.**
- **We recommend that an authorized HYUNDAI dealer replace the air bag immediately after deployment. Air bags are designed to be used only once.**

Noise and smoke from inflating air bag

When the air bags inflate, they make a loud noise and may produce smoke and powder in the air inside of the vehicle. This is normal and is a result of the ignition of the air bag inflator. After the air bag inflates, you may feel substantial discomfort in breathing because of the contact of your chest with both the seat belt and the air bag, as well as from breathing the smoke and powder. The powder may aggravate asthma for some people. If you experience breathing problems after an air bag deployment, seek medical attention immediately.

Though the smoke and powder are nontoxic, they may cause irritation to the skin, eyes, nose, throat, etc. If this is the case, wash and rinse with cold water immediately and seek medical attention if the symptoms persist.

Do not install a Child Restraint System on the front passenger seat



Never install a Child Restraint System in the front passenger seat, unless the air bag is deactivated

⚠ WARNING

NEVER use a rearward facing Child Restraint on a seat protected by an ACTIVE AIRBAG in front of it, DEATH or SERIOUS INJURY to the CHILD can occur.

Why didn't my air bag go off in a collision?

There are certain types of accidents in which the air bag would not be expected to provide additional protection. These include rear impacts, second or third collisions in multiple impact accidents, as well as low speed impacts. Damage to the vehicle indicates a collision energy absorption, and is not an indicator of whether or not an air bag should have inflated.

Air bag collision sensors

WARNING

To reduce the risk of an air bag deploying unexpectedly and causing serious injury or death:

- Do not hit or allow any objects to impact the locations where air bags or sensors are installed.
- Do not perform maintenance on or around the air bag sensors. If the location or angle of the sensors is altered, the air bags may deploy when they should not or may not deploy when they should.
- Do not install bumper guards or replace the bumper with a non-genuine part. This may adversely affect the collision and air bag deployment performance.

- Place the START/STOP button to the OFF position, when the vehicle is being towed to prevent inadvertent air bag deployment.
- We recommend that all air bag repairs be performed by an authorized HYUNDAI dealer.



- 1. SRS control module
- 2. Front impact sensor
- 3. Side pressure sensor (front door)
- 4. Side impact sensor (B-pillar)

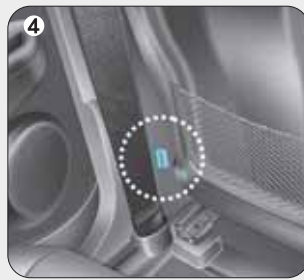

OOSEV038015R/OOSEV038016R/OOSEV038017R/OOS037047R/OOS037077R

Air bag inflation conditions



Front air bags

Front air bags are designed to inflate in a frontal collision depending on the severity of impact of the front collision.



Side and curtain air bags

Side and curtain air bags are designed to inflate when an impact is detected by side collision sensors depending on the severity of impact resulting from a side impact collision.

Although the driver's and front passenger's air bags are designed to inflate in frontal collisions, they also may inflate in other types of collisions if the front impact sensors detect a sufficient impact. Side and curtain air bags are designed to inflate in side impact collisions, but they may inflate in other collisions if the side impact sensors detect a sufficient impact.

If the vehicle chassis is impacted by bumps or objects on unimproved roads, the air bags may deploy. Drive carefully on unimproved roads or on surfaces not designed for vehicle traffic to prevent unintended air bag deployment.

Air bag non-inflation conditions



In certain low-speed collisions the air bags may not deploy. The air bags are designed not to deploy in such cases because they may not provide benefits beyond the protection of the seat belts.



Front air bags are not designed to inflate in rear collisions, because occupants are moved backward by the force of the impact. In this case, inflated air bags would not provide any additional benefit.



Front air bags may not inflate in side impact collisions, because occupants move in the direction of the collision, and thus in side impacts, front air bag deployment would not provide additional occupant protection.

However, side and curtain air bags may inflate depending on the severity of the impact.



In an angled collision, the force of impact may direct the occupants in a direction where the air bags would not be able to provide any additional benefit, and thus the sensors may not deploy any air bags.



Just before impact, drivers often brake heavily. Such heavy braking lowers the front portion of the vehicle causing it to “ride” under a vehicle with a higher ground clearance. Air bags may not inflate in this “under-ride” situation because deceleration forces that are detected by sensors may be significantly reduced by such “underride” collisions.

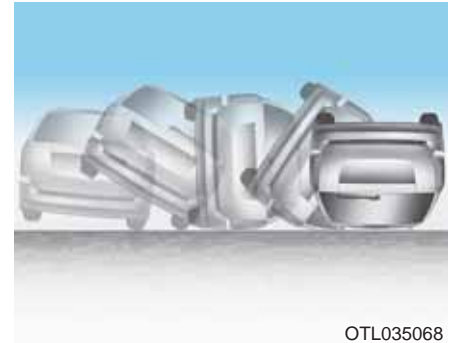

Front air bags may not inflate in rollover accidents because front air bag deployment would not provide additional occupant protection.

i Information

The side and/or curtain air bags may inflate when the vehicle is rolled over by a side impact collision, if the vehicle is equipped with side and/or curtain air bags.



Air bags may not inflate if the vehicle collides with objects such as utility poles or trees, where the point of impact is concentrated and the collision energy is absorbed by the vehicle structure.

SRS care

The SRS is virtually maintenance-free and there are no parts you can safely service by yourself. If the SRS air bag warning light does not illuminate when the START/STOP button is in the ON position, or continuously remains on, we recommend that the system be immediately inspected by an authorized HYUNDAI dealer.

We recommend any work on the SRS system, such as removing, installing, repairing, or any work on the steering wheel, the front passenger's panel, front seats and roof rails be performed by an authorized HYUNDAI dealer. Improper handling of the SRS system may result in serious personal injury.

WARNING

To reduce the risk of serious injury or death take the following precautions:

- Do not attempt to modify or disconnect the SRS components or wiring, including the addition of any kind of badges to the pad covers or modifications to the body structure.
- Do not place objects over or near the air bag modules on the steering wheel, instrument panel, and the front passenger's panel above the glove box.

- Clean the air bag pad covers with a soft cloth moistened with plain water. Solvents or cleaners could adversely affect the air bag covers and proper deployment of the system.
- We recommend that inflated air bags be replaced by an authorized HYUNDAI dealer.
- If components of the air bag system must be discarded, or if the vehicle must be scrapped, certain safety precautions must be observed. Consult an authorized HYUNDAI dealer for the necessary information. Failure to follow these precautions could increase the risk of personal injury.

Additional safety precautions

Passengers should not move out of or change seats while the vehicle is moving. A passenger who is not wearing a seat belt during a crash or emergency stop can be thrown against the inside of the vehicle, against other occupants, or be ejected from the vehicle.

Do not use any accessories on seat belts. Devices claiming to improve occupant comfort or reposition the seat belt can reduce the protection provided by the seat belt and increase the chance of serious injury in a crash.

Do not modify the front seats.

Modification of the front seats could interfere with the operation of the supplemental restraint system sensing components or side air bags.

Do not place items under the front seats. Placing items under the front seats could interfere with the operation of the supplemental restraint system sensing components and wiring harnesses.

Do not cause impact to the doors. Impact to the doors when the START/STOP button is in the ON position may cause the air bags to inflate.

Adding equipment to or modifying your air bag equipped vehicle

If you modify your vehicle by changing your vehicle's frame, bumper system, front end or side sheet metal or ride height, this may affect the operation of your vehicle's air bag system.

Air bag warning labels



Air bag warning labels are attached to alert the passengers of potential risks of the air bag system.

Be sure to read all of the information about the air bags that are installed on your vehicle in this Owner's Manual.

Convenient Features of Your Vehicle

Accessing your vehicle	4-3	Resetting the sunroof	4-31
Smart key.....	4-3	Sunroof open warning	4-32
Immobilizer system.....	4-8	Exterior features	4-33
Door locks	4-9	Hood.....	4-33
Operating door locks from outside the vehicle.....	4-9	Tailgate.....	4-34
Operating door locks from inside the vehicle.....	4-10	Charging door.....	4-37
Auto door lock/unlock features.....	4-12	Instrument cluster	4-38
Child-protector rear door locks.....	4-12	Instrument cluster control.....	4-39
Theft-alarm system	4-14	Gauges and meters.....	4-40
Steering wheel	4-15	Warning and indicator lights.....	4-46
Electric power steering (EPS).....	4-15	LCD display messages.....	4-57
Tilt steering / Telescope steering.....	4-16	LCD display	4-70
Heated steering wheel.....	4-17	LCD display control.....	4-70
Horn.....	4-17	LCD display modes.....	4-71
Mirrors	4-18	Trip computer	4-81
Inside rearview mirror	4-18	Lighting	4-85
Outside rearview mirror	4-19	Exterior lights	4-85
Windows	4-23	Low Beam Assist-Static light.....	4-91
Power windows	4-23	Welcome system	4-91
Sunroof	4-28	Interior lights	4-92
Sunshade	4-28	Wipers and washers	4-95
Tilt open/close.....	4-29	Front windshield wipers.....	4-95
Slide open/close.....	4-29	Front windshield washers.....	4-97
Automatic reversal.....	4-30	Rear window wiper and washer switch.....	4-98

Driver assist system	4-99	Interior features	4-128
Rear view monitor	4-99	Cup holder	4-128
Parking Distance Warning (Reverse) system	4-100	Sunvisor.....	4-129
Parking Distance Warning (Reverse/Forward) system	4-104	Power outlet.....	4-129
Automatic climate control system	4-109	USB charger	4-130
Automatic heating and air conditioning	4-110	Wireless cellular phone charging system	4-131
Manual heating and air conditioning	4-111	Clock.....	4-133
System operation.....	4-118	Clothes hanger	4-134
System maintenance.....	4-119	Floor mat anchor(s).....	4-134
Windshield defrosting and defogging	4-121	Luggage net (holder)	4-135
To defog inside windshield	4-121	Cargo area cover	4-136
To defrost outside windshield.....	4-122	Roof rack.....	4-137
Defogging logic	4-122	Exterior features	4-137
Defroster	4-122		
Auto defogging system	4-123		
Climate control additional features	4-125		
Automatic ventilation.....	4-125		
Storage compartment	4-126		
Center console storage	4-126		
Glove box	4-126		
Sunglass holder	4-127		

ACCESSING YOUR VEHICLE

Smart key



Your HYUNDAI uses a Smart Key, which you can use to lock or unlock a door (and tailgate) and even start the vehicle.

1. Door Lock
2. Door Unlock
3. Tailgate Unlock

Locking



To lock :

1. Close all doors, hood and tailgate.
2. Either press the door handle button or press the Door Lock button (1) on the smart key.
3. The hazard warning lights and chime will blink once. Also, the outside rearview mirror will fold, if the outside rearview mirror folding switch is in the AUTO position (if equipped).
4. Make sure the doors are locked by checking the position of the door lock button inside the vehicle.

i Information

The door handle button will only operate when the smart key is within 0.7~1 m (28~40 in.) from the outside door handle.

Even though you press the outside door handle button, the doors will not lock and the chime will sound for three seconds if any of the following occur:

- The Smart Key is in the vehicle.
- The START/STOP button is in ON position.
- Any door except the tailgate is open.

WARNING

Do not leave the Smart Key in your vehicle with unsupervised children. Unattended children could press the START/STOP button and may operate power windows or other controls, or even make the vehicle move, which could result in serious injury or death.

Unlocking



To unlock:

1. Carry the Smart Key.
2. Either press the door handle button or press the Door Unlock button (2) on the smart key.
3. The doors will unlock. The hazard warning lights will blink two times. Also, the outside rearview mirror will unfold, if the outside rearview mirror folding switch is in the AUTO position (if equipped).

Information

- The door handle button will only operate when the smart key is within 0.7~1 m (28~40 in.) from the outside door handle. Other people can also open the doors without the smart key in possession.
- After unlocking the doors, the doors will lock automatically after 30 seconds unless a door is opened.

Tailgate unlocking

To unlock:

1. Carry the smart key.
2. Either press the tailgate handle button or press the Tailgate Unlock button (3) on the smart key for more than one second.
3. The hazard warning lights and chime will blink two times.

Once the tailgate is opened and then closed, the tailgate will lock automatically.

***i* Information**

After unlocking the tailgate, the tailgate will lock automatically after 30 seconds unless the tailgate is opened.

Start-up

You can start the vehicle without inserting the key. **For detailed information, refer to the START/STOP button in chapter 5.**

NOTICE

To prevent damaging the smart key:

- **Keep the smart key away from water or any liquid and fire. If the inside of the smart key gets damp (due to drinks or moisture), or is heated, internal circuit may malfunction, excluding the car from the warranty.**
- **Avoid dropping or throwing the smart key.**
- **Protect the smart key from extreme temperatures.**

Mechanical key

If the Smart Key does not operate normally, you can lock or unlock the door by using the mechanical key.



Move the release lever in the direction of the arrow (1) and then remove the mechanical key (2). Insert the mechanical key into the key hole on the door.

To reinstall the mechanical key, put the key into the hole and push it until a click sound is heard.

Loss of a smart key

A maximum of two smart keys can be registered to a single vehicle. If you happen to lose your smart key, it is recommended that you should immediately take the vehicle and remaining key to your authorized HYUNDAI dealer or tow the vehicle, if necessary.

Smart key precautions

The smart key may not work if any of the following occur:

- The smart key is close to a radio transmitter such as a radio station, military area, police station, government offices, broadcasting stations, transmission towers, port or an airport which can interfere with normal operation of the transmitter.
- The smart key is near a mobile two way radio system or a mobile phone.
- The smart key is close to a metal product or coins.
- Another vehicle's smart key is being operated close to your vehicle

In the following situations, the frequency band from the smart key may be mixed with a different frequency, which may cause smart key malfunction (motor operation, door lock function, etc.) or the working distance of smart key may change:

- The smart key is placed near the electronic systems (woofer, mobile phone, portable wired/wireless charger, electric heating device, electronic power bank, e-cigarettes, etc.).
- When you connect an external device to the multi-purpose socket or USB port and place it near the smart key, the smart key may not be recognized/work in some areas of the vehicle. In this case, try moving the smart key to another location to start the vehicle or press the start button directly with the smart key to start the vehicle.

When the smart key does not work correctly, open and close the door with the mechanical key. If you have a problem with the smart key, it is recommended that you contact an authorized HYUNDAI dealer.

If the smart key is in close proximity to your mobile phone, the signal could be blocked by your mobile phone's normal operational signals. This is especially important when the phone is active such as making and receiving calls, text messaging, and/or sending/receiving emails.

Avoid placing the smart key and your mobile phone in the same pants or jacket pocket and always try to maintain an adequate distance between the two devices.

i Information

Changes or modifications not expressly approved by the party responsible for compliance could void the user's authority to operate the equipment. If the keyless entry system is inoperative due to changes or modifications not expressly approved by the party responsible for compliance, it will not be covered by your manufacturer's vehicle warranty.

NOTICE

Keep the smart key away from electromagnetic materials that blocks electromagnetic waves to the key surface.

NOTICE

Always have the smart key with you when leaving the vehicle. If the smart key is left near the vehicle, the vehicle battery may be discharged.

Battery replacement



If the Smart Key is not working properly, try replacing the battery with a new one.

Battery Type: CR2032

To replace the battery:

1. Remove the mechanical key.
2. Use a slim tool to pry open the rear cover of the smart key.
3. Remove the old battery and insert the new battery. Make sure the battery position is correct.
4. Reinstall the rear cover of the smart key.

If you suspect your smart key might have sustained some damage, or you feel your smart key is not working correctly, it is recommended that you contact an authorized HYUNDAI dealer.

WARNING

THIS PRODUCT CONTAINS A BUTTON BATTERY.

If swallowed, a lithium button battery can cause severe or fatal injuries within 2 hours. Keep batteries out of reach of children. If you think batteries may have been swallowed or placed inside any part of the body, seek immediate medical attention.

Information



An inappropriately disposed battery can be harmful to the environment and human health. Dispose of the battery according to your local law(s) and regulation.

Immobilizer system

The immobilizer system protects your vehicle from theft. If an improperly coded key (or other device) is used, the power system is disabled.

When the START/STOP button is placed in the ON position, the immobilizer system indicator should come on briefly, then go off. If the indicator starts to blink, the system does not recognize the coding of the key.

Place the START/STOP button to the OFF position, then place the START/STOP button to the ON position again.

The system may not recognize your key's coding if another immobilizer key or other metal object (for example, key chain) is near the key. The vehicle may not start because the metal may interrupt the transponder signal from transmitting normally.

If the system repeatedly does not recognize the coding of the key, it is recommended that you contact your HYUNDAI dealer.

Do not attempt to alter this system or add other devices to it. Electrical problems could result that may make your vehicle inoperable.

WARNING

In order to prevent theft of your vehicle, do not leave spare keys anywhere in your vehicle. Your immobilizer password is a customer unique password and should be kept confidential.

NOTICE

The transponder in your key is an important part of the immobilizer system. It is designed to give years of trouble-free service, however you should avoid exposure to moisture, static electricity and rough handling. Immobilizer system malfunction could occur.

Disclaimer:

The system is designed in such a way that it makes vehicle theft difficult if its circuit and battery connection is uninterrupted.

DOOR LOCKS

Operating door locks from outside the vehicle

Mechanical key



[A] : Lock, [B] : Unlock

Turn the key toward the rear of the vehicle to unlock and toward the front of the vehicle to lock.

If you lock/unlock the driver's door with a key, the driver's door will lock/unlock automatically.

Once the doors are unlocked, they may be opened by pulling the door handle.

When closing the door, push the door by hand. Make sure that doors are closed securely.

Smart key



To lock the doors, press the button on the outside door handle while carrying the smart key with you or press the door lock button on the smart key.

To unlock the doors, press the button on the outside door handle while carrying the smart key with you or press the door unlock button on the smart key.

Once the doors are unlocked, they may be opened by pulling the door handle.

When closing the door, push the door by hand. Make sure that doors are closed securely.

i Information

- In cold and wet climates, door lock and door mechanisms may not work properly due to freezing conditions.
- If the door is locked/unlocked multiple times in rapid succession with either the vehicle key or door lock switch, the system may stop operating temporarily in order to protect the circuit and prevent damage to system components.

Operating door locks from inside the vehicle

With the door lock button



- To unlock a door, pull the door lock button (1) to the “Unlock” position. The red mark (2) on the door lock button will be visible.
- To lock a door, push the door lock button (1) to the “Lock” position. If the door is locked properly, the red mark (2) on the door lock button will not be visible.
- To open a door, pull the door handle (3) outward.

- Doors cannot be locked if the smart key is in the vehicle and any door is open.

i Information

If a power door lock ever fails to function while you are in the vehicle try one or more of the following techniques to exit:

Operate the door unlock feature repeatedly (both electronic and manual) while simultaneously pulling on the door handle.

Operate the other door locks and handles, front and rear.

Lower a front window and use the mechanical key to unlock the door from outside.

With the door handle

Front door

If the inner door handle is pulled when the door is locked, the door will unlock and open.

Rear door

If the inner door handle is pulled once when the door is locked, the door will unlock.

If the inner door handle is pulled once more, the door will open.

With the central door lock switch

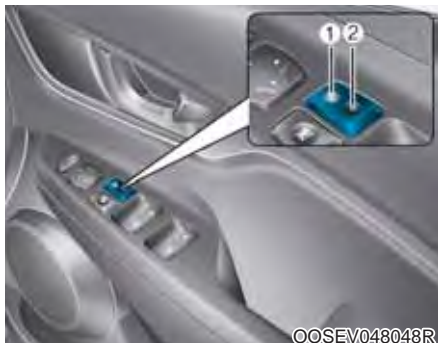

- When pressing the (🔒) portion (1) of the switch, all vehicle doors will lock.
 - If the smart key is in the vehicle and any door is opened, the doors will not lock even though the lock button (1) of the central door lock switch is pressed.
- When pressing the (🔓) portion (2) of the switch, all vehicle doors will unlock.

⚠ WARNING

- The doors should always be fully closed and locked while the vehicle is in motion. If the doors are unlocked, the risk of being thrown from the vehicle in a crash is increased.
- Do not pull the inner door handle of driver's or passenger's door while the vehicle is moving.

⚠ WARNING

Do not leave the elderly, children or animals unattended in your vehicle. An enclosed vehicle can become extremely hot, causing death or serious injury to the elderly, unattended children or animals who cannot escape from the vehicle. Children might operate features of the vehicle that could injure them, or they could encounter other harm, possibly from someone gaining entry to the vehicle.

⚠ WARNING

Always secure your vehicle

Leaving your vehicle unlocked increases the potential risk to you or others from someone hiding in your vehicle.

To secure your vehicle, while depressing the brake, shift to the P (Park) position, engage the parking brake, and place the START/STOP button in the OFF position, close all windows, lock all doors, and always take the key with you.

⚠ WARNING

If you stay in the vehicle for a long time while the weather is very hot or cold, there are risks of injuries or danger to life. Do not lock the vehicle from the outside when someone is in the vehicle.

WARNING

Opening a door when something is approaching may cause damage or injury. Be careful when opening doors and watch for vehicles, motorcycles, bicycles or pedestrians approaching the vehicle in the path of the door.

Auto door lock/unlock features

Impact sensing door unlock system (if equipped)

All doors will be automatically unlocked when an impact causes the air bags to deploy.

Speed sensing door lock system (if equipped)

All doors will be automatically locked when vehicle speed exceeds 15 km/h (9 mph).

You can activate or deactivate the Auto Door Lock/Unlock features from the User Settings Mode on the LCD display. **For more details, refer to "LCD Display" in this chapter.**

Child-protector rear door locks



The child safety lock is provided to help prevent children seated in the rear from accidentally opening the rear doors. The rear door safety locks should be used whenever children are in the vehicle.

The child safety lock is located on the edge of each rear door. When the child safety lock is in the lock position, the rear door will not open if the inner door handle (2) is pulled.

To lock the child safety lock, insert a key (or screwdriver) (1) into the hole and turn it to the lock position.

To allow a rear door to be opened from inside the vehicle, unlock the child safety lock.

 **WARNING**

If children accidentally open the rear doors while the vehicle is in motion, they could fall out of the vehicle. The rear door safety locks should always be used whenever children are in the vehicle.

THEFT-ALARM SYSTEM

This system helps to protect your vehicle and valuables. The horn will sound and the hazard warning lights will blink continuously if any of the following occurs:

- A door is opened without using the smart key.
- The tailgate is opened without using the smart key.
- The hood is opened.

The alarm continues for 30 seconds, then the system resets. To turn off the alarm, unlock the doors with the smart key.

The Theft Alarm System automatically sets 30 seconds after you lock the doors and the tailgate. For the system to activate, you must lock the doors and the tailgate from outside the vehicle with the smart key or by pressing the button on the outside of the door handles with the smart key in your possession.

The hazard warning lights will blink and the chime will sound once to indicate the system is armed.

Once the security system is set, opening any door, the tailgate, or the hood without using the smart key will cause the alarm to activate.

The Theft Alarm System will not set if the hood, the tailgate, or any door is not fully closed. If the system will not set, check the hood, the tailgate, or the doors are fully closed.

Do not attempt to alter this system or add other devices to it.

i Information

- **Do not lock the doors until all passengers have left the vehicle. If the remaining passenger leaves the vehicle when the system is armed, the alarm will be activated.**
- **If the vehicle is not disarmed with the smart key, open the doors by using the mechanical key, start the vehicle and wait for 30 seconds.**
- **When the system is disarmed but a door or tailgate is not opened within 30 seconds, the system will be rearmed.**



i Information

Vehicles equipped with a theft alarm system will have a label attached to the vehicle with the following words:

1. WARNING
2. SECURITY SYSTEM

Disclaimer:

The system is designed in such a way that it makes vehicle theft difficult if its circuit and battery connection is uninterrupted.

STEERING WHEEL

Electric power steering (EPS)

The system assists you with steering the vehicle. If the vehicle is off or if the power steering system becomes inoperative, the vehicle may still be steered, but it will require increased steering effort.

Also, the steering effort becomes heavier as the vehicle's speed increases and becomes lighter as the vehicle's speed decreases for better control of the steering wheel.

Should you notice any change in the effort required to steer during normal vehicle operation, we recommend that the system be checked by an authorized HYUNDAI dealer.

NOTICE

- **If the Electric Power Steering System does not operate normally, the warning light (⊕!) will illuminate or blink on the instrument cluster. The steering wheel may become difficult to control or operate. Take your vehicle to an authorized HYUNDAI dealer and have the system checked as soon as possible.**
- **When abnormality is detected in the electric power steering system, to prevent a deadly accident, the steering assist function will stop. At this time, the warning light turns on or blinks on the cluster. The steering wheel may become difficult to control or operate. Have your vehicle checked immediately, after moving the vehicle to a safe zone.**

i Information

The following symptoms may occur during normal vehicle operation:

- The steering effort may be high immediately after placing the START/STOP button in the ON position. This happens as the system performs the EPS system diagnostics. When the diagnostics is completed, the steering wheel will return to its normal condition.
- A click noise may be heard from the EPS relay after the START/STOP button is in the ON or OFF position.
- Motor noise may be heard when the vehicle is at a stop or at a low driving speed.
- When you operate the steering wheel in low temperature, abnormal noise may occur. If temperature rises, the noise will disappear. This is a normal condition.

- When the vehicle is stationary, if you turn the steering wheel all the way to the left or right continuously, the steering wheel effort increases. This is not a system malfunction. As time passes, the steering wheel effort will return to its normal condition.

Tilt steering / Telescope steering

WARNING

Never adjust the steering wheel while driving. You may lose steering control and cause severe personal injury, death or accidents.

Information

After adjustment, sometimes the lock-release lever may not lock the steering wheel.

It is not a malfunction. This occurs when two gears are not engaged correctly. In this case, adjust the steering wheel again and then lock the steering wheel.



To change the steering wheel angle and height:

1. Pull down the lock-release lever (1).
2. Adjust the steering wheel to the desired angle (2) and height (3). Move the steering wheel, so it points toward your chest, not toward your face. Make sure you can see the instrument panel warning lights and gauges. After adjusting, pull up the lock
3. Pull up the lock-release lever to lock the steering wheel in place.

Push the steering wheel both up and down to be certain it is locked in position.

Heated steering wheel (if equipped)



When the vehicle is ON, press the heated steering wheel button to warm the steering wheel. The indicator on the button will illuminate. To turn the heated steering wheel off, press the button again. The indicator on the button will turn off.

i Information

The heated steering wheel will turn off automatically approximately 30 minutes after the heated steering wheel is turned on.

NOTICE

Do not install any cover or accessory on the steering wheel. This cover or accessory could cause damage to the heated steering wheel system.

Horn



To sound the horn, press the area indicated by the horn symbol on your steering wheel. The horn will operate only when this area is pressed.

NOTICE

Do not strike the horn severely to operate it, or hit it with your fist. Do not press on the horn with a sharp-pointed object.

MIRRORS

Inside rearview mirror

Before you start driving, adjust the rearview mirror to the center on the view through the rear window.

WARNING

Make sure your line of sight is not obstructed. Do not place objects in the rear seat, cargo area, or behind the rear headrests which could interfere with your vision through the rear window.

WARNING

To prevent serious injury during an accident or deployment of the air bag, do not modify the rearview mirror and do not install a wide mirror.

WARNING

NEVER adjust the mirror while driving. This may cause loss of vehicle control resulting in an accident.

NOTICE

When cleaning the mirror, use a paper towel or similar material dampened with glass cleaner. Do not spray glass cleaner directly on the mirror as that may cause the liquid cleaner to enter the mirror housing.

Day/night rearview mirror (if equipped)



[A] : Day, [B] : Night

Make this adjustment before you start driving and while the day/night lever is in the day position.

Pull the day/night lever toward you to reduce glare from the headlights of the vehicles behind you during night driving.

Remember that you lose some rearview clarity in the night position.

Electric Chromic Mirror (ECM) (if equipped)

The electric rearview mirror automatically controls the glare from the headlamp of the car behind you in night-time or low light driving conditions.

When the vehicle is ON, the glare is automatically controlled by the sensor mounted in the rearview mirror. The sensor detects the light level around the vehicle, and automatically adjusts to control the headlamp glare from vehicles behind you.

Whenever the gear is shifted to R (Reverse), the mirror will automatically go to the brightest setting in order to improve the drivers view behind the vehicle.



[A] : Indicator

To operate the electric rearview mirror:

- Press the ON/OFF button (1) to turn the automatic dimming function off. The mirror indicator light will turn off.

Press the ON/OFF button (1) to turn the automatic dimming function on. The mirror indicator light will illuminate.

- The mirror defaults to the ON position whenever the START/STOP button is in the ON position.

Outside rearview mirror



Be sure to adjust mirror angles before driving.

Your vehicle is equipped with both left-hand and right-hand outside rearview mirrors.

The mirror can be adjusted remotely with the remote switch.

The mirror heads can be folded to prevent damage during an automatic car wash or when passing through a narrow street.

⚠ WARNING

- The left and right outside rearview mirrors are convex. Objects seen in the mirror are closer than they appear.
- Use your interior rearview mirror or turn your head and look to determine the actual distance of following vehicles when changing lanes.

⚠ WARNING

Do not adjust or fold the outside rearview mirrors while driving. This may cause loss of vehicle control resulting in an accident.

NOTICE

- Do not scrape ice off the mirror face; this may damage the surface of the glass.
- If the mirror is jammed with ice, do not adjust the mirror by force. Use an approved de-icer (not radiator antifreeze) spray, or a sponge or soft cloth with very warm water, or move the vehicle to a warm place and allow the ice to melt.

Adjusting the rearview mirrors



1. Press either the L (left side) or R (right side) button (1) to select the rearview mirror you would like to adjust.
2. Use the mirror adjustment control (2) to position the selected mirror up, down, left or right.
3. After adjustment, put the button into neutral (center) position to prevent inadvertent adjustment.

NOTICE

- The mirrors stop moving when they reach the maximum adjusting angles, but the motor continues to operate while the switch is pressed. Do not press the switch longer than necessary, the motor may be damaged.
- Do not attempt to adjust the outside rearview mirror by hand or the motor may be damaged.

Folding the outside rearview mirror



Manual type (if equipped)

To fold the outside rearview mirror, grasp the housing of the mirror and then fold it toward the rear of the vehicle.



Electric type (if equipped)

Left : The mirror will unfold.

Right : The mirror will fold.

Center (AUTO) : The mirror will fold or unfold automatically as follows:

- The mirror will fold or unfold when the door is locked or unlocked by the smart key.
- The mirror will fold or unfold when the door is locked or unlocked by the button on the outside door handle.
- The mirror will unfold when the vehicle is approached with the smart key and 'Welcome mirror' in the User Setting mode on the LCD display is selected (if equipped).

NOTICE

The electric type outside rearview mirror operates even though the START/STOP button is in the OFF position. However, to prevent unnecessary battery discharge, do not adjust the mirrors longer than necessary while the vehicle is not in the ready () mode.

NOTICE

Do not fold the electric type outside rearview mirror by hand. It could cause motor failure.

WINDOWS

Power windows

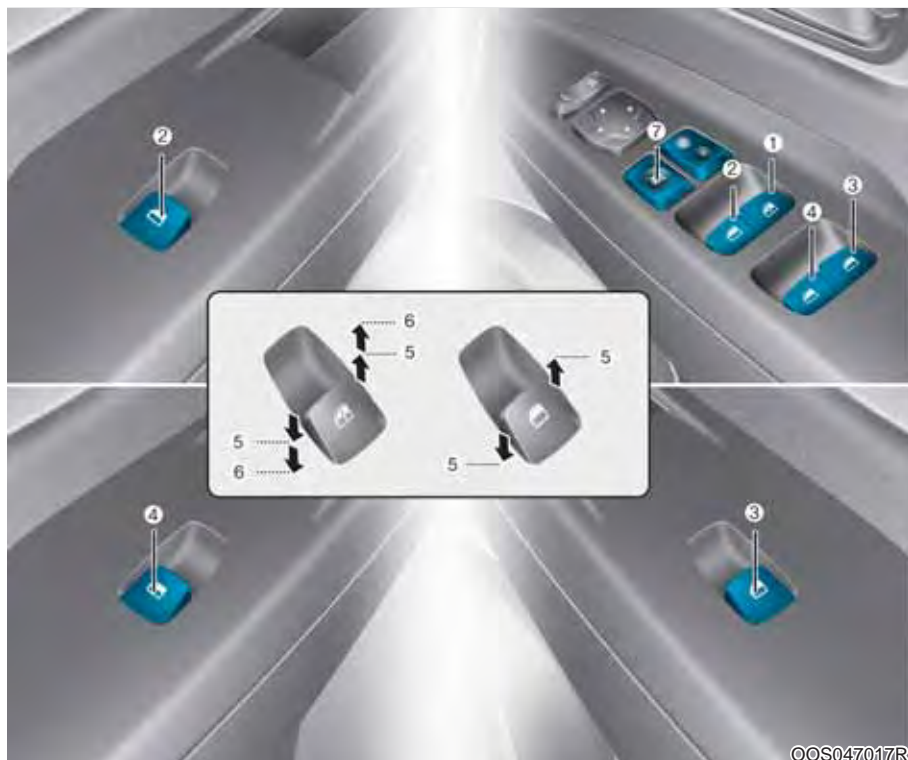

- (1) Driver's door power window switch
- (2) Front passenger's door power window switch
- (3) Rear door (right) power window switch
- (4) Rear door (left) power window switch
- (5) Window opening and closing
- (6) Automatic power window*
- (7) Power window lock switch

* : if equipped

The START/STOP button must be in the ON position to be able to raise or lower the windows. Each door has a Power Window switch to control that door's window. The driver has a Power Window Lock switch which can block the operation of rear passenger windows. The power windows will operate for approximately 10 minutes after the START/STOP button is placed in the ACC or OFF position. However, if the front doors are opened, the Power Windows cannot be operated even within the 10 minutes period.

WARNING

To avoid serious injury or death, do not extend your head, arms or body outside the windows while driving.

Information

- **In cold and wet climates, power windows may not work properly due to freezing conditions.**
- **While driving with the rear windows down or with the sunroof (if equipped) opened (or partially opened), your vehicle may demonstrate a wind buffeting or pulsation noise. This noise is normal and can be reduced or eliminated by taking the following actions. If the noise occurs with one or both of the rear windows down, partially lower both front windows approximately 2.5 cm. If you experience the noise with the sunroof open, slightly close the sunroof.**

Window opening and closing



To open:

Press the window switch down to the first detent position (5). Release the switch when you want the window to stop.

To close:

Pull the window switch up to the first detent position (5). Release the window switch when you want the window to stop.

Auto down window (if equipped)

Pressing the power window switch momentarily to the second detent position (6) completely lowers the window even when the switch is released. To stop the window at the desired position while the window is in operation, pull up or press down and release the switch.

Auto up/down window (if equipped)

Pressing or pulling up the power window switch momentarily to the second detent position (6) completely lowers or lifts the window even when the switch is released. To stop the window at the desired position while the window is in operation, pull up or press down and release the switch.

To reset the power windows

If the power windows do not operate normally, the automatic power window system must be reset as follows:

1. Place the START/STOP button to the ON position.
2. Close the window and continue pulling up on the power window switch for at least one second.

If the power windows do not operate properly after resetting, it is recommended that the system be checked by an authorized HYUNDAI dealer.

⚠ WARNING

The automatic reverse feature doesn't activate while resetting the power window system. Make sure body parts or other objects are safely out of the way before closing the windows to avoid injuries or vehicle damage.

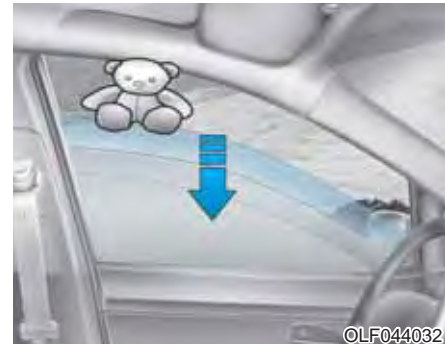
Automatic reverse (if equipped)

If a window senses any obstacle while it is closing automatically, it will stop and lower approximately 30 cm (12 inches) to allow the object to be cleared.

If the window detects the resistance while the power window switch is pulled up continuously, the window will stop upward movement then lower approximately 2.5 cm (1 inch).

If the power window switch is pulled up continuously again within 5 seconds after the window is lowered by the automatic window reverse feature, the automatic window reverse will not operate.

i Information

The automatic reverse feature is only active when the “Auto Up” feature is used by fully pulling up the switch to the second detent.

⚠ WARNING

Make sure body parts or other objects are safely out of the way before closing the windows to avoid injuries or vehicle damage.

Objects less than 4 mm (0.16 inch) in diameter caught between the window glass and the upper window channel may not be detected by the automatic reverse window and the window will not stop and reverse direction.

NOTICE

Do not install any accessories on the windows. The automatic reverse feature may not operate.

Power window lock switch



The driver can disable the power window switches on the rear passengers' doors by pressing the power window lock switch.

When the power window lock switch is pressed:

- The driver's master control can operate all the power windows.
- The front passenger's control can operate the front passenger's power window.
- The rear passenger's control cannot operate the rear passengers' power window.

⚠ WARNING

Do not allow children to play with the power windows. Keep the driver's door power window lock switch in the LOCK position. Serious injury or death can result from unintentional window operation by a child.

NOTICE

- To prevent possible damage to the power window system, do not open or close two windows or more at the same time. This will also ensure the longevity of the fuse.
- Never try to operate the main switch on the driver's door and the individual door window switch in opposite directions at the same time. If this is done, the window will stop and cannot be opened or closed.

⚠ WARNING

- **NEVER** leave the keys in your vehicle with unsupervised children, when the vehicle is ON.
- **NEVER** leave any child unattended in the vehicle. Even very young children may inadvertently cause the vehicle to move, entangle themselves in the windows, or otherwise injure themselves or others.
- Always double check to make sure all arms, hands, head and other obstructions are safely out of the way before closing a window.

- Do not allow children to play with the power windows. Keep the driver's door power window lock switch in the LOCK position (pressed). Serious injury can result from unintentional window operation by the child.
- Do not extend your head, arms or body outside the windows while driving.

SUNROOF (IF EQUIPPED)

If your vehicle is equipped with a sunroof, you can slide or tilt your sunroof with the sunroof control switch located on the overhead console.



The sunroof can only be operated when the Start/Stop button is in the ON or START position.

The sunroof can be operated for approximately 10 minutes after the Start/Stop button is in the ACC or OFF position. However, if the front door is open, the sunroof cannot be operated even within the 10 minutes period.

WARNING

- **Adjust the sunroof or sunshade when your vehicle stops. Adjusting the sunroof while driving could result in loss of control and an accident that may cause injury, or property damage.**
- **Do not leave the ready indicator () on and the key in your vehicle with unsupervised children. Unattended children could operate the sunroof, which could result in serious injury.**
- **Do not sit on the top of the vehicle. It may cause injury or vehicle damage.**

NOTICE

Do not operate the sunroof when roof bars are installed on the vehicle or when there is luggage on the roof.

Sunshade



Use the sunshade to block direct sunlight coming through the sunroof glass.

Open or close the sunshade by hand.

Information

The sunshade opens automatically when the sunroof glass is opened, but the sunshade does not close automatically when the sunroof glass is closed. Also, only the sunshade cannot be closed when the sunroof glass is opened.

Tilt open/close

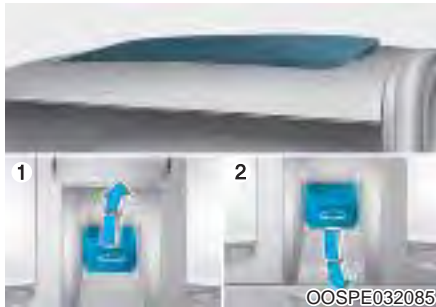

1. Tilt open
2. Tilt close

- Push the sunroof switch upward, the sunroof glass tilts open.
- Push the sunroof switch forward when the sunroof glass is tilt opened, the sunroof glass closes.

The sunroof glass tilts open or closes while the switch is pushed.

i Information

The sunroof glass cannot slide open and tilt open at the same time. You cannot tilt the sunroof glass open while the sunroof glass is slide open. Also, you cannot slide the sunroof glass open while the sunroof is tilt open. Slide open or tilt open the sunroof glass when the sunroof glass is completely closed.

Slide open/close



- Push the sunroof switch rearward, the sunshade and sunroof glass slide open.
Push the sunroof switch forward, only the sunroof glass closes.
- Push the sunroof switch forward or rearward to the first detent position, the sunroof glass moves until the switch is released.
- Push the sunroof switch forward or rearward to the second detent position, the sunroof glass operates automatically (auto slide feature). To stop the sunroof movement at any point, push the sunroof switch in any direction.

- The sunroof glass stops halfway (first detent position) before it is fully opened. To fully open the sunroof glass, push the sunroof switch rearward once more. At this time, the sunroof glass opens only while the switch is pushed.

Automatic reversal (If equipped)



If the sunroof glass senses any obstacle while it is closing automatically, it will reverse direction then stop at a certain position.

The auto reverse function may not work if an object thin or soft is caught between the sliding sunroof glass and sunroof sash.

⚠ WARNING

- **Make sure heads, hands, arms or any other body parts or objects are out of the way before operating the sunroof. Body parts or objects may get caught causing injuries or vehicle damage.**
- **Never deliberately use your body parts to test the automatic reversal function. The sunroof glass may reverse direction, but there is a risk of injury.**

NOTICE

- **Do not continue to push the sunroof switch after the sunroof is fully opened, closed, or tilted. Damage to the sunroof motor could occur.**
- **Continuous operations such as slide open/close, tilt open/close, etc. may cause the motor or sunroof system to malfunction.**
- **Regularly remove any accumulated dust on the sunroof rail.**

- Dust accumulated between the sunroof and roof panel can make noise. Open the sunroof and remove dust regularly using a clean cloth.
- Do not try to open the sunroof when the temperature is below freezing or when the sunroof is covered with snow or ice. The sunroof may not work properly and may break if opened by force.
- Do not open or drive with the sunroof glass open immediately after rain or washing the vehicle. Water may wet the interior of the vehicle.
- Do not extend any luggage outside the sunroof while driving. Vehicle damage may occur if the vehicle suddenly stops.

WARNING

Do not extend your head, arms, body parts or objects outside the sunroof while driving. Injuries may occur if the vehicle suddenly stops.

Resetting the sunroof



In some circumstances resetting the sunroof operation may need to be performed. Some instances where resetting the sunroof may be required include:

- When the 12-volt battery is either disconnected or discharged
- When the sunroof fuse is replaced
- If the sunroof one-touch AUTO OPEN/CLOSE operation is not functioning properly

Sunroof resetting procedure:

1. It is recommended to perform the reset procedure with the ready indicator () on. Start the vehicle in P (Park).
2. Make sure the sunroof glass is in the fully closed position. If the sunroof glass is open, push the switch forward until the sunroof glass is fully closed.
3. Release the switch when the sunroof glass is fully closed.
4. Push the switch forward until the sunroof glass moves slightly. Then release the switch.
5. Once again push and hold the sunroof switch forward until the sunroof glass slides open and close. Do not release the switch until the operation is completed. If you release the switch during operation, start the procedure again from step 2.

i Information

If the sunroof is not reset when the vehicle battery is disconnected or discharged, or the sunroof fuse is blown, the sunroof may not operate normally.

Sunroof open warning (if equipped)

- If the driver turns off the vehicle when the sunroof is not fully closed, the warning chime will sound for several seconds and the sunroof open warning will appear on the cluster LCD display. Close the sunroof securely when leaving your vehicle.



CAUTION

Make sure the sunroof is closed fully when leaving your vehicle. If the sunroof is left open, rain or snow may wet the interior of the vehicle. Also, leaving the sunroof open when the vehicle is unattended may invite theft.

EXTERIOR FEATURES

Hood

Opening the hood



1. Park the vehicle and set the parking brake.
2. Pull the release lever to unlatch the hood. The hood should pop open slightly.



3. Go to the front of the vehicle, raise the hood slightly, push the secondary hood release lever up (1) inside of the hood center and lift the hood (2).
4. Pull out the support rod.



5. Hold the hood opened with the support rod (3).

⚠ WARNING

- Grasp the support rod in the area wrapped in rubber. The rubber will help prevent you from being burned by hot metal.
- The support rod must be inserted completely into the hole provided whenever you inspect the motor compartment. This will prevent the hood from falling and possibly injuring you.

Closing the hood

1. Before closing the hood, check the following:
 - All filler caps in motor room must be correctly installed.
 - Gloves, rags or any other combustible material must be removed from the motor compartment.
2. Return the support rod to its clip to prevent it from rattling.
3. Lower the hood halfway (lifted approximately 30cm from the closed position) and push down to securely lock in place. Then double check to be sure the hood is secure.

If the hood can slightly be raised, it is not securely locked. Open it again and close it with more force.

⚠ WARNING

- **Before closing the hood, ensure all obstructions are removed from around the hood opening.**
- **Always double check to be sure that the hood is firmly latched before driving away. Check there is no hood open warning light or message displayed on the instrument cluster. If the hood is not latched while the vehicle is moving, the chime will sound to warn the driver the hood is not fully latched. Driving with the hood opened may cause a total loss of visibility, which might result in an accident.**
- **Do not move the vehicle with the hood in the raised position, as vision is obstructed, which might result in an accident, and the hood could fall or be damaged.**

Tailgate

Opening the tailgate

Make sure the gear is shifted to P (Park) and set the parking brake.



Then do one of the following:

1. Unlock all doors with the Door Unlock button on your remote key or smart key. Press the tailgate handle button and open the tailgate.
2. Press and hold the Tailgate Unlock button on the remote key or smart key. Press the tailgate handle button and open the tailgate.
3. With the Smart Key in your possession, press the tailgate handle button and open the tailgate.

Closing the tailgate



Lower the tailgate lid and press down until it locks. To be sure the tailgate lid is securely fastened, always check by trying to pull it up again.

i Information

To prevent damage to the tailgate lift cylinders and the attached hardware, always close the tailgate before driving.

NOTICE

In cold and wet climates, tailgate lock and tailgate mechanisms may not work properly due to freezing conditions.

⚠ WARNING



OHMK047009

Do not hold the part (gas lifter) that supports the tailgate. Be aware that the deformation of the part may cause vehicle damage and a risk of safety accident.

⚠ WARNING

- **NEVER** allow anyone to occupy the tailgate of the vehicle at any time. If the luggage compartment is partially or totally latched and the person is unable to get out, serious injury or death could occur due to lack of ventilation and rapid heat build-up, or because of exposure to cold weather conditions. The luggage compartment is also a highly dangerous location in the event of a crash because it is not a protected occupant space but is a part of the vehicle's crush zone.
- Your vehicle should be kept locked and keys should be kept out of the reach of children. Parents should teach their children about the dangers of playing in luggage compartment.

Emergency tailgate safety release



Your vehicle is equipped with the emergency tailgate safety release lever located on the bottom of the tailgate. When someone is inadvertently locked in the luggage compartment. The tailgate can be opened by doing as follows:

1. Insert the key into the hole.
2. Push the release lever to the right by a key.
3. Push up the tailgate.

⚠ WARNING

- For emergencies, be fully aware of the location of the emergency tailgate safety release lever in the vehicle and how to open the tailgate if you are accidentally locked in the luggage compartment.
- No one should be allowed to occupy the luggage compartment of the vehicle at any time. The luggage compartment is a very dangerous location in the event of a crash.
- Use the release lever for emergencies only. Use with extreme caution, especially while the vehicle is in motion.

Charging door

Opening the charging door



1. Depress the brake pedal and apply the parking brake.
2. Turn OFF all switches, shift to P (Park), and turn OFF the vehicle.
3. Push the charging door where the icon is located to open. The charging door opens only when the door is unlocked.

i Information

If you cannot open the charging door due to freezing weather, tap lightly or remove any ice near the charging door. Do not try to forcibly open the charging door.

Closing the charging door



1. After recharging, install the charging inlet cover.
2. Close the charging door until it is latched securely.

For more details, refer to the Electric Vehicle Guide provided in the front of the owner's manual.

INSTRUMENT CLUSTER

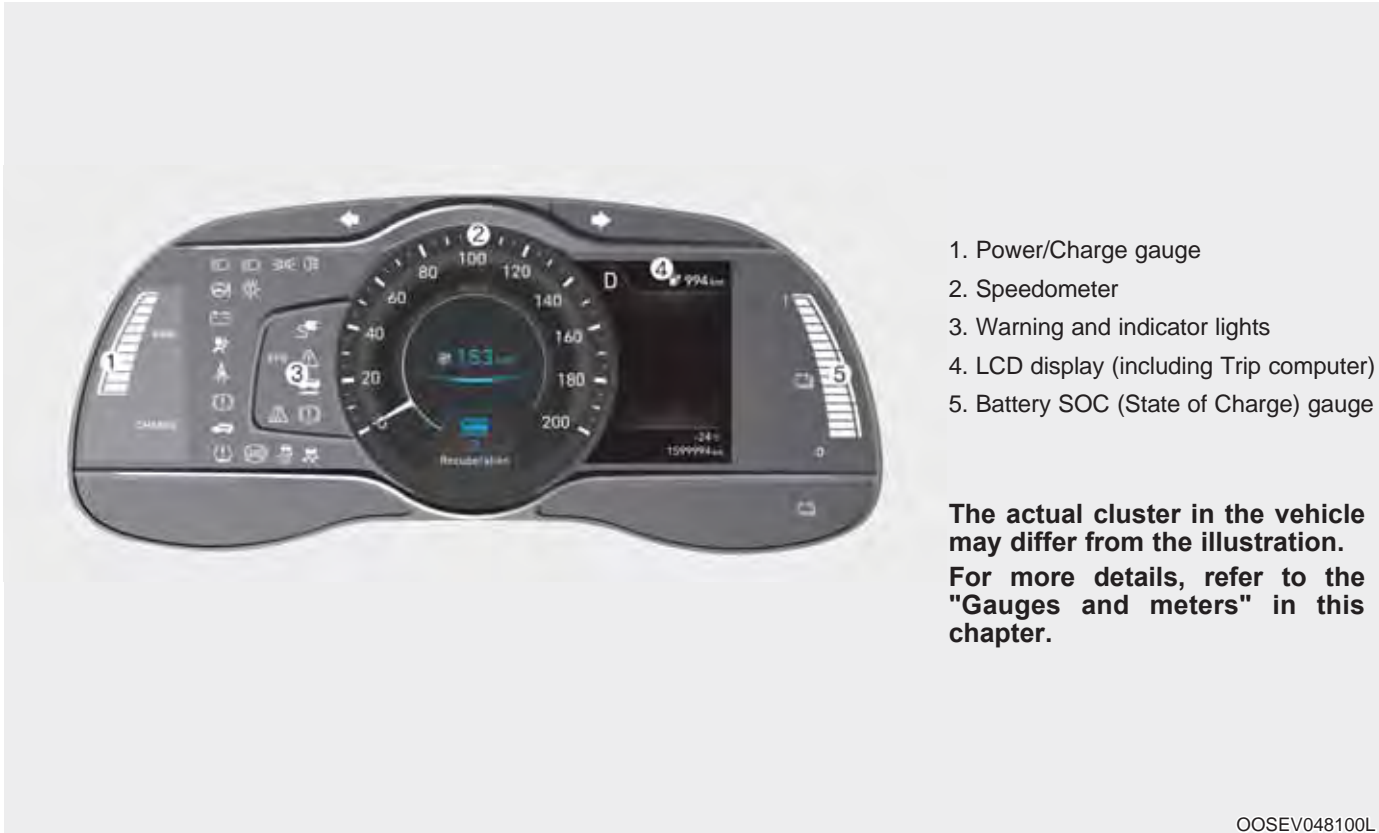

1. Power/Charge gauge
2. Speedometer
3. Warning and indicator lights
4. LCD display (including Trip computer)
5. Battery SOC (State of Charge) gauge

The actual cluster in the vehicle may differ from the illustration. For more details, refer to the "Gauges and meters" in this chapter.

OOSEV048100L

Instrument cluster control

Instrument panel illumination



When the vehicle's position lights or headlights are on, press the illumination control button to adjust the brightness of the instrument panel illumination.

When pressing the illumination control button, the interior switch illumination intensity is also adjusted.

WARNING

Never adjust the instrument cluster while driving. This could result in loss of control and lead to an accident that may cause death, serious injury, or property damage.



- The brightness of the instrument panel illumination is displayed.
- If the brightness reaches the maximum or minimum level, a chime will sound.

Gauges and meters

Speedometer



The speedometer indicates the speed of the vehicle and is calibrated in kilometers per hour (km/h) and/or miles per hour (MPH).

The speedometer is displayed differently according to the selected drive mode in the Drive Mode Integrated Control System.

For more details, refer to “Drive Mode Integrated Control System” in chapter 5.

Sub speedometer



The sub speedometer is displayed on the cluster when you select ‘Other features → Speedometer subscale’ in the User Settings mode. The sub speedometer is not displayed if you deselect it in the User Setting mode.

For more details, refer to “LCD Display Mode” in this chapter.

Toque gauge



The torque gauge shows the realtime torque value while driving when SPORT mode is selected by pressing the DRIVE MODE button.

Power/Charge gauge



The Power/Charge gauge shows the energy consumption rate of the vehicle and the charge/discharge status of the regenerative brakes.

- **CHARGE :**

It shows the charging status of the battery when it is being charged by the regenerative brakes (decelerating or driving on a downhill road). The more electric energy is charged, the lower the gauge level.

- **POWER :**

It shows the energy consumption rate of the vehicle when driving uphill or accelerating. The more electric energy is used, the higher the gauge level.

State of Charge (SOC) gauge for high voltage battery



The SOC gauge shows the charging status of the high voltage battery.

"L (Low)" position on the indicator indicates that there is not enough energy in the high voltage battery. "H (High)" position indicates that the driving battery is fully charged.

When driving on highways or motorways, make sure to check in advance if the driving battery is charged enough.



When there are 2 gauge bars (near the "L (Low) or 0" area) on the SOC gauge, the warning lamp turns ON to alert you of the battery level.

When the warning lamp turns ON, the vehicle can drive an additional 20~30 km (12~18 miles) depending on the driving speed, heater/air conditioner, weather, driving style, and other factors. Charging is required.

NOTICE

When there are 1-2 gauge bars left for the high voltage battery, the vehicle speed is limited and then eventually the vehicle will turn OFF. Charge the vehicle immediately.

Outside temperature gauge

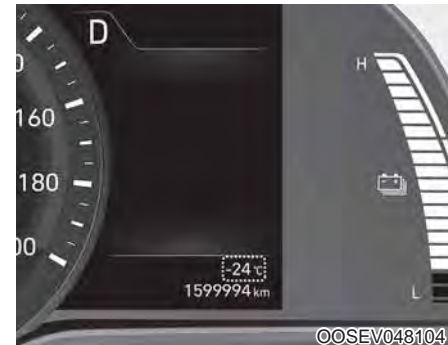

This gauge indicates the current outside air temperatures either in Celsius (°C) or Fahrenheit.

- Temperature range :
 - 40°C ~ 60°C (-40°F ~ 140°F)

The outside temperature on the display may not immediately change like a general thermometer not to distract the driver.

The temperature unit (from °C to °F or from °F to °C) can be changed by:

- User Settings mode in the Cluster : You can change the temperature unit in the “Other Features -Temperature unit” .
- Automatic climate control system : While pressing the OFF button, press the AUTO button for 3 seconds or more.

The temperature unit of the instrument cluster and climate control system will change at once.

Odometer

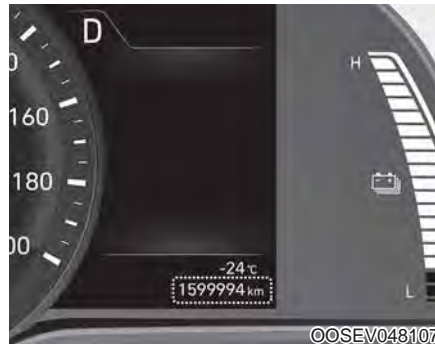

The odometer indicates the total distance that the vehicle has been driven and should be used to determine when periodic maintenance should be performed.

Distance to empty



- The distance to empty is the estimated distance the vehicle can be driven with remaining level of the high voltage battery.

For more details, refer to “Distance to Empty” in the Electric Vehicle Guide in front of the owner’s manual.

- The distance to empty is displayed differently according to the selected drive mode in the Drive Mode Integrated Control System. **For more details, refer to “Drive Mode Integrated Control System” in chapter 5.**

Additional Distance to Empty from Regenerative Braking



The additional distance to empty which is converted from the energy regenerated by the regenerative braking is displayed if the ECO/ECO+ mode is selected by pressing the Drive Mode button. The display is initialized to 0 if the regenerative braking stops because of acceleration, etc.

Reduction gear shift indicator



This indicator displays which gear is selected.³

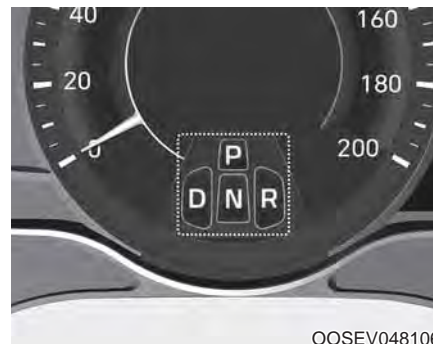

Shift indicator pop-up (if equipped)

The pop-up indicates the current gear position displayed in the cluster for about 2 seconds when shifting into other positions (P/R/N/D).

The shift indicator pop-up function can be activated or deactivated from the User Settings mode in the cluster LCD display.

Regenerative braking level indicator



While using the regenerative brakes, you may select the regenerative braking level from 0 to 3 by pulling the paddle shifter.

For more details, refer to “Regenerative Braking System” in chapter 5.

Smart ECO pedal guide



The Smart Eco Pedal Guide is displayed to lead to eco-driving when you press the DRIVE MODE button and select ECO/ECO+ mode.

- (1) Eco-driving guide
- (2) The driver's acceleration pedaling level
- (3) Section beyond the eco-driving guide

- Guides slow acceleration when driving at low speed.
- Guides driving considering the optimal fuel economy when driving at medium speed.
- Guides constant speed driving and deceleration when driving at high speed.

Warning and indicator lights

i Information

Make sure that all warning lights are **OFF** after starting the vehicle. If any light is still **ON**, this indicates a situation that needs attention.

Ready Indicator



This indicator illuminates:

When the vehicle is ready to be driven.

- ON : Normal driving is possible.
- OFF : Normal driving is not possible, or a problem has occurred.
- Blinking : Emergency driving.

When the ready indicator goes OFF or blinks, there is a problem with the system. In this case, we recommend that you have your vehicle inspected by an authorized HYUNDAI dealer.

Service Warning Light



This warning light illuminates:

- When the START/STOP button is in the ON position.
 - It illuminates for approximately 3 seconds and then goes off.
- When there is a problem with related parts of the electric vehicle control system, such as sensors, etc.

When the warning light illuminates while driving, or does not go OFF after starting the vehicle, we recommend that you have your vehicle inspected by an authorized HYUNDAI dealer.

Power Down Indicator Light



This indicator light illuminates:

- When the power is limited for the safety of the electric vehicle.

The power is limited for the following reasons.

 - The high voltage battery level is below a certain level or voltage is decreasing
 - The temperature of the motor or high voltage battery is too high or too low
 - There is a problem with the cooling system, or a failure that may interrupt normal driving

NOTICE

- Do not accelerate or start the vehicle suddenly when the power down warning light is ON.
- When the power is limited for the safety of the high-powered parts of an electric vehicle, the power down indicator light illuminates. Your vehicle may not be driven, or may roll back on a slope with the indicator light ON due to the limitation of vehicle power.

Charging Indicator Light



This warning light illuminates:

- When charging the high voltage battery.

High Voltage Battery Low Level Warning Light



This warning light illuminates:

- When the high voltage battery level is low. When the warning light turns ON, charge the battery immediately.

Air Bag Warning Light



This warning light illuminates:

- When the START/STOP button is in the ON position.
 - It illuminates for approximately 6 seconds and then goes off.
- When there is a malfunction with the SRS. In this case, we recommend that you have the vehicle inspected by an authorized HYUNDAI dealer.

Seat Belt Warning Light



This warning light informs the driver that the seat belt is not fastened.

For more details, refer to the “Seat Belts” in chapter 2.

Parking Brake & Brake Fluid Warning Light



This warning light illuminates:

- When the START/STOP button is in the ON position.
 - It illuminates for approximately 3 seconds
 - It remains on if the parking brake is applied.
- When the parking brake is applied.
- When the brake fluid level in the reservoir is low.
 - If the warning light illuminates with the parking brake released, it indicates the brake fluid level in reservoir is low.
- When the regenerative brake does not operate.

If the brake fluid level in the reservoir is low:

1. Drive carefully to the nearest safe location and stop your vehicle.
2. With the vehicle turned off, check the brake fluid level immediately and add fluid as required (For more details, refer to “Brake Fluid” in chapter 7). After adding brake fluid, check all brake components for fluid leaks. If a brake fluid leak is found, or if the warning light remains on, or if the brakes do not operate properly, do not drive the vehicle. We recommend you to have the vehicle inspected by an authorized HYUNDAI dealer.

Dual-diagonal braking system

Your vehicle is equipped with dual-diagonal braking systems. This means you still have braking on two wheels even if one of the dual systems should fail.

With only one of the dual systems working, more than normal pedal travel and greater pedal pressure is required to stop the vehicle.

Also, the vehicle will not stop in as short a distance with only a portion of the brake system working.

⚠ WARNING

Parking Brake & Brake Fluid Warning Light

Driving the vehicle with a warning light ON is dangerous. If the Parking Brake & Brake Fluid Warning Light illuminates with the parking brake released, it indicates that the brake fluid level is low.

In this case, we recommend that you have the vehicle inspected by an authorized HYUNDAI dealer.

Regenerative Brake Warning Light



This warning light illuminates:

When the regenerative brake does not operate and the brake does not perform well. This causes the Brake Warning light (red) and Regenerative Brake Warning Light (yellow) to illuminate simultaneously.

In this case, drive safely and we recommend that you have your vehicle inspected by an authorized HYUNDAI dealer.

The operation of the brake pedal may be more difficult than normal and the braking distance can increase.

Anti-lock Brake System (ABS) Warning Light



This warning light illuminates:

- When the START/STOP button is in the ON position.
 - It illuminates for approximately 3 seconds and then goes off.
- When there is a malfunction with the ABS (The normal braking system will still be operational without the assistance of the anti-lock brake system).

In this case, we recommend that you have the vehicle inspected by an authorized HYUNDAI dealer.

Electronic Brake Force Distribution (EBD) System Warning Light



These two warning lights illuminate at the same time while driving:

- When the ABS and regular brake system may not work normally.

In this case, we recommend that you have the vehicle inspected by an authorized HYUNDAI dealer.

⚠ WARNING

Electronic Brake Force Distribution (EBD) System Warning Light

When both ABS and Parking Brake & Brake Fluid Warning Lights are on, the brake system will not work normally and you may experience an unexpected and dangerous situation during sudden braking.

In this case, avoid high speed driving and abrupt braking.

We recommend you have the vehicle inspected by an authorized HYUNDAI dealer as soon as possible.

i Information - Electronic Brake Force Distribution (EBD) System Warning Light

When the ABS Warning Light is on or both ABS and Parking Brake & Brake Fluid Warning Lights are on, the speedometer, odometer, or tripmeter may not work. Also, the EPS Warning Light may illuminate and the steering effort may increase or decrease.

In this case, we recommend you have the vehicle inspected by an authorized HYUNDAI dealer as soon as possible.

Electric Power Steering (EPS) Warning Light



This warning light illuminates:

- When the START/STOP button is in the ON position.
 - It illuminates for approximately 3 seconds and then goes off.
- When there is a malfunction with the EPS.

In this case, we recommend that you have the vehicle inspected by an authorized HYUNDAI dealer.

Charging System Warning Light (for 12-volt battery)

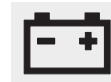

This warning light illuminates:

- When the 12-volt battery level is low or a failure occurs on the charging system such as LDC.
- If the warning light turns on while driving, move the vehicle to a safe location, turn off and turn on the vehicle again, and check if the warning light turns off. If the warning light remains on, we recommend that you have the vehicle inspected by an authorized HYUNDAI dealer.
- Even if the warning light turns off, we recommend that you have the vehicle inspected by an authorized HYUNDAI dealer.

If you drive the vehicle while the warning light is on, vehicle speed may be limited and the 12-volt battery may be discharged.

* LDC : Low voltage DC-DC Converter.

Master Warning Light



This indicator light illuminates:

- When there is a malfunction in operation in any of the following systems:
 - LED headlamp malfunction (if equipped)
 - Lamp malfunction
 - High Beam Assist malfunction (if equipped)
 - Tire Pressure Monitoring System (TPMS) malfunction

To identify the details of the warning, look at the LCD display.

Low Tire Pressure Warning Light



This warning light illuminates:

- When the START/STOP button is in the ON position.
 - It illuminates for approximately 3 seconds and then goes off.
- When one or more of your tires are significantly underinflated.

For more details, refer to “Tire Pressure Monitoring System (TPMS)” in chapter 6.

This warning light remains ON after blinking for approximately 60 seconds, or repeatedly blinks ON and OFF in 3 second intervals:

- When there is a malfunction with the TPMS.
 - In this case, we recommend that you have the vehicle inspected by an authorized HYUNDAI dealer as soon as possible.

For more details, refer to “Tire Pressure Monitoring System (TPMS)” in chapter 6.

WARNING

Safe Stopping

- The TPMS cannot alert you to severe and sudden tire damage caused by external factors.
- If you notice any vehicle instability, immediately take your foot off the accelerator pedal, apply the brake pedal gradually with light force, and slowly move to a safe position off the road.

Electronic Parking Brake (EPB) Warning Light

EPB

This warning light illuminates:

- When the START/STOP button is in the ON position.
 - It illuminates for approximately 3 seconds and then goes off.
- When there is a malfunction with the EPB.

In this case, we recommend that you have the vehicle inspected by an authorized HYUNDAI dealer.

Information

The Electronic Parking Brake (EPB) Warning Light may illuminate when the Electronic Stability control (ESC) Indicator Light comes on to indicate that the ESC is not working properly (This does not indicate malfunction of the EPB).

Forward Collision-Avoidance Assist (FCA) System Warning Light (if equipped)



This indicator light illuminates:

- When the START/STOP button is in the ON position.
 - It illuminates for approximately 3 seconds and then goes off.
- When there is a malfunction with the FCA.

In this case, we recommend that you have the vehicle inspected by an authorized HYUNDAI dealer.

For more details, refer to "Forward Collision-Avoidance Assist (FCA) System" in chapter 5.

Lane Keeping Assist (LKA) System Indicator Light (if equipped)



This indicator light illuminates:

- [Green] When the system operating conditions are satisfied.
- [White] The system operating conditions are not satisfied.
- [Yellow] When there is a malfunction with the lane keeping assist system.

In this case, we recommend that you have your vehicle inspected by an authorized HYUNDAI dealer.

For more details, refer to "Lane Keeping Assist (LKA) System" in chapter 5.

Icy Road Warning Light (if equipped)



This warning light is to warn the driver the road may be icy.

When the temperature on the outside temperature gauge is approximately below 4°C (40°F), the Icy Road Warning Light and Outside Temperature Gauge blinks and then illuminates. Also, the warning chime sounds 1 time.

The Icy Road Warning function can be activated or deactivated from the User Settings mode in the cluster LCD display.

***i* Information**

If the icy road warning light appears while driving, you should drive more attentively and safely, refraining from over-speeding, rapid acceleration, sudden braking or sharp turning, etc.

AUTO HOLD Indicator Light



This indicator light illuminates:

- [White] When you activate the auto hold system by pressing the AUTO HOLD switch.
- [Green] When you stop the vehicle completely by depressing the brake pedal with the auto hold system activated.
- [Yellow] When there is a malfunction with the auto hold system. In this case, we recommend that you have the vehicle inspected by an authorized HYUNDAI dealer.

For more details, refer to “Auto Hold” in chapter 5.

Electronic Stability Control (ESC) Indicator Light



This indicator light illuminates:

- When the START/STOP button is in the ON position.
 - It illuminates for approximately 3 seconds and then goes off.
- When there is a malfunction with the ESC system.

In this case, we recommend that you have the vehicle inspected by an authorized HYUNDAI dealer.

This indicator light blinks:

- While the ESC is operating.

For more details, refer to “Electronic Stability Control (ESC)” in chapter 5.

Electronic Stability Control (ESC) OFF Indicator Light



This indicator light illuminates:

- When the START/STOP button is in the ON position.
 - It illuminates for approximately 3 seconds and then goes off.
- When you deactivate the ESC system by pressing the ESC OFF button.

For more details, refer to “Electronic Stability Control (ESC)” in chapter 5.

Immobilizer Indicator Light



This indicator light illuminates for up to 30 seconds:

- When the vehicle detects the smart key in the vehicle with the START/STOP button in the ACC or ON position.
 - At this time, you can start the vehicle.
 - The indicator light goes off after starting the vehicle.

This indicator light blinks for a few seconds:

- When the smart key is not in the vehicle.
 - At this time, you cannot start the vehicle.

This indicator light illuminates for 2 seconds and goes off:

- If the smart key is in the vehicle and the START/STOP button is ON, but the vehicle cannot detect the smart key.

In this case, we recommend that you have the vehicle inspected by an authorized HYUNDAI dealer.

This indicator light blinks:

- When the battery voltage of the smart key is low.
 - At this time, you can not start the vehicle. However, you can start the vehicle if you press the START/STOP button with the smart key. (For more details, refer to "Starting the vehicle" in chapter 5).
- When there is a malfunction with the immobilizer system.

In this case, we recommend that you have the vehicle inspected by an authorized HYUNDAI dealer.

Turn Signal Indicator Light



This indicator light blinks:

- When you operate the turn signal indicator light.

If any of the following occurs, there may be a malfunction with the turn signal system.

- The turn signal indicator light illuminates but does not blink
- The turn signal indicator light blinks rapidly
- The turn signal indicator light does not illuminate at all

If either of these conditions occur, we recommend you to have your vehicle inspected by an authorized HYUNDAI dealer.

Low Beam Indicator Light (if equipped)



This indicator light illuminates:

- When the headlights are on.

High Beam Indicator Light



This indicator light illuminates:

- When the headlights are on and in the high beam position
- When the turn signal lever is pulled into the Flash-to-Pass position.

Light ON Indicator Light

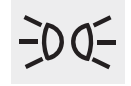

This indicator light illuminates:

- When the position lights or headlights are on.

Rear Fog Indicator Light (if equipped)



This indicator light illuminates:

- When the rear fog lights are on.

LED Headlamp Warning Light (if equipped)



This warning light illuminates:

- When the START/STOP button is in the ON position.
 - It illuminates for approximately 3 seconds and then goes off.
- When there is a malfunction with the LED headlamp.

In this case, we recommend that you have the vehicle inspected by an authorized HYUNDAI dealer.

This warning light blinks:

When there is a malfunction with a LED headlamp related part.

In this case, we recommend that you have the vehicle inspected by an authorized HYUNDAI dealer.

NOTICE

Continuous driving with the LED Headlamp Warning Light on or blinking can reduce LED headlamp life.

Cruise Indicator Light (if equipped)

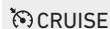

This indicator light illuminates:

- When the cruise control system is enabled.

For more details, refer to "Cruise Control System" in chapter 5.

SPORT Mode Indicator Light



This indicator light illuminates:

- When you select "SPORT" mode as drive mode.

For more details, refer to "Drive Mode Integrated Control System" in chapter 5.

ECO Mode Indicator Light (if equipped)



This indicator light illuminates:

- When you select "ECO" mode as drive mode.

For more details, refer to "Drive Mode Integrated Control System" in chapter 5.

ECO Mode Indicator Light (if equipped)



This indicator light illuminates:

- When you select "ECO" mode as drive mode.

For more details, refer to "Drive Mode Integrated Control System" in chapter 5.

UTIL (Utility) Mode Indicator



This indicator light illuminates:

- When Utility mode is activated from the User Settings mode.

For more details, refer to the **Electric Vehicle Guide** provided in the front of the owner's manual.

Overspeed Warning

This is to prevent you from fast driving.

- When you drive the vehicle more than 80 km/h, the overspeed warning chime sounds once per 100 seconds.
- When you drive the vehicle more than 120 km/h, the overspeed warning chime also sounds continuously.

LCD display messages

Driving Info display

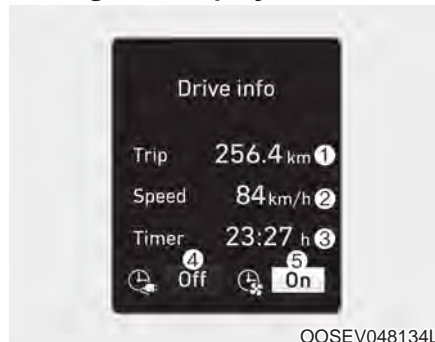

At the end of each driving cycle, the Driving Info message is displayed. This display shows the trip distance (1), average vehicle speed (2), driving time (3), charging time status (4) and climate time status (5).

This information is displayed for a few seconds when you turn off the vehicle, and then goes off automatically. The information is calculated for each time the vehicle is turned on.

i Information

- If sunroof open warning is displayed in the cluster, the Driving Info message will not be displayed.
- To set the charging time and/or climate time, refer to a separately supplied Multimedia System manual for detailed information.

Shift to P

This warning message is displayed if you try to turn off the vehicle with the gear in the N (Neutral) position.

At this time, the START/STOP button changes to the ACC position (If you press the START/STOP button once more, it will turn to the ON position).

Low key battery

This warning message is displayed if the battery of the smart key is discharged while changing the START/STOP button to the OFF position.

Press START/STOP button while turning wheel

This warning message is displayed if the steering wheel does not unlock normally when the START/STOP button is pressed.

You should press the START/STOP button while turning the steering wheel right and left.

Check steering wheel lock system

This warning message is displayed if the steering wheel does not lock normally while the START/STOP button changes to the OFF position.

Press brake pedal to start vehicle

This warning message is displayed if the START/STOP button changes to the ACC position twice by pressing the button repeatedly without depressing the brake pedal.

You can start the vehicle by depressing the brake pedal.

Key not in vehicle

This warning message is displayed if the smart key is not in the vehicle when you press the START/STOP button.

When attempting to start the vehicle, always have the smart key with you.

Key not detected

This warning message is displayed if the smart key is not detected when you press the START/STOP button.

Press START/STOP button again

This message is displayed if you were unable to start the vehicle when the START/STOP button was pressed.

If this occurs, attempt START/STOP button again.

If the warning message appears each time you press the START/STOP button, we recommend you to have your vehicle inspected by an authorized HYUNDAI dealer.

Press START/STOP button with key

This warning message is displayed if you press the START/STOP button while the warning message “Key not detected” is displayed.

At this time, the immobilizer indicator light blinks.

Check BRAKE SWITCH fuse

This warning message is displayed if the brake switch fuse is disconnected.

You need to replace the fuse with a new one before starting the vehicle.

If that is not possible, you can start the vehicle by pressing the START/STOP button for 10 seconds in the ACC position.

Shift to P to start vehicle

This warning message is displayed if you try to start the vehicle without shifting to the P (Park) position.

Low washer fluid (if equipped)

This warning message is displayed if the washer fluid level in the reservoir is nearly empty.

Have the washer fluid reservoir refilled.

12V battery discharging due to additional electrical devices

This warning message is displayed if the 12V battery discharge is detected due to use of unauthorized electrical/electronic devices. Some vehicle functions will not be able to use and the 12V battery may discharge. If the message continues to appear even though the external electrical/electronic device is removed, we recommend that the vehicle be inspected by an authorized HYUNDAI dealer.

Door, Hood, Tailgate open

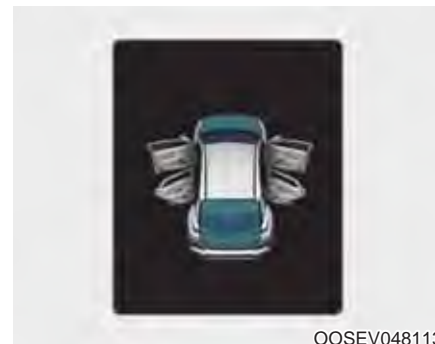

OOSEV048113

This warning is displayed indicating which door, or hood, or tailgate is open.



CAUTION

Before driving the vehicle, you should confirm that the door/hood/tailgate are fully closed. Also, check there is no door/hood/tailgate open warning light or message displayed on the instrument cluster.

Sunroof open (if equipped)



This warning is displayed if you turn off the vehicle when the sunroof is open.

Low pressure (if equipped)



This warning message is displayed if the tire pressure is low. The corresponding tire on the vehicle will be illuminated.

For more details, refer to "Tire Pressure Monitoring System (TPMS)" in chapter 6.

Turn on FUSE SWITCH



This warning message is displayed if the fuse switch located on the fuse box under the steering wheel is OFF. You should turn the fuse switch on.

For more details, refer to "Fuses" in chapter 7.

Lights mode



This indicator displays which exterior light is selected using the lighting control.

Wiper mode



This indicator displays which wiper speed is selected using the wiper control.

Parking distance warning system malfunction (if equipped)



This warning is displayed if there is a problem with the Parking Distance Warning system. We recommend that you have the vehicle inspected by an authorized dealer of HYUNDAI.

For more details, refer to “Parking Distance Warning system” in chapter 3.

Check headlamp LED (if equipped)

This warning message is displayed if there is a problem with the LED headlamp. We recommend that you have the vehicle inspected by an authorized HYUNDAI dealer.

Check headlamp FAN (if equipped)

This warning message is displayed if there is a problem with headlamp fan. We recommend that you have the vehicle inspected by an authorized HYUNDAI dealer.

Check headlight (if equipped)

This warning message is displayed if the headlamps are not operating properly. The headlamp bulb may need to be replaced.

***i* Information**

Make sure to replace the burned out bulb with a new one of the same wattage rating.

Check brake light (if equipped)

This warning message is displayed if the stop lamps are not operating properly. A lamp may need to be replaced.

Check turn signal (if equipped)

This warning message is displayed if the turn signal lamps are not operating properly. A lamp may need to be replaced.

Check cornering lamp (if equipped)

This warning message is displayed if the cornering lamps are not operating properly. A lamp may need to be replaced.

Heated steering wheel turned Off (if equipped)

This message is displayed if you turn off the heated steering wheel.

For more details, refer to “Heated Steering Wheel” in this chapter.

Check HBA (High Beam Assist) system

This warning message is displayed if there is a problem with the High Beam Assist (HBA) System. We recommend that you have the vehicle inspected by an authorized HYUNDAI dealer.

For more details, refer to “High Beam Assist (HBA) System” in chapter 3.

Check FCA (Forward Collision Avoidance Asst.) (if equipped)

This warning message is displayed if there is a problem with the Forward Collision-Avoidance Assist (FCA) system. We recommend that you have the vehicle inspected by an authorized HYUNDAI dealer.

For more details, refer to “Forward Collision-Avoidance Assist (FCA) system” in chapter 5.

Check SLW (Speed Limit Warning) system

This warning message is displayed if there is a problem with the Intelligent Speed Limit Warning (ISLW) system. We recommend that you have the vehicle inspected by an authorized HYUNDAI dealer.

For more details, refer to “Intelligent Speed Limit Warning (ISLW)” in chapter 5.

Check SCC (Smart Cruise Control) system (if equipped)

This warning message is displayed if there is a problem with the Smart Cruise Control system. We recommend that you have the vehicle inspected by an authorized HYUNDAI dealer.

For more details, refer to “Smart Cruise Control with Stop & Go” in chapter 5.

Check LKA (Lane Keep Assist) system (if equipped)

This warning message is displayed if there is a problem with the Lane Keeping Assist (LKA) system. We recommend that you have the vehicle inspected by an authorized HYUNDAI dealer.

For more details, refer to “Lane Keeping Assist (LKA) system” in chapter 5.

Check DAW (Driver Attention Warning) system (if equipped)

This warning message is displayed if there is a problem with the Driver Attention Warning (DAW) system. We recommend that you have the vehicle inspected by an authorized HYUNDAI dealer.

For more details, refer to “Driver Attention Warning (DAW) system” in chapter 5.

Shift to P to charge



This message is displayed if you connect the charging cable without the gear in the P (Park) position. Shift to P (Park) before connecting the charging cable.

Remaining time

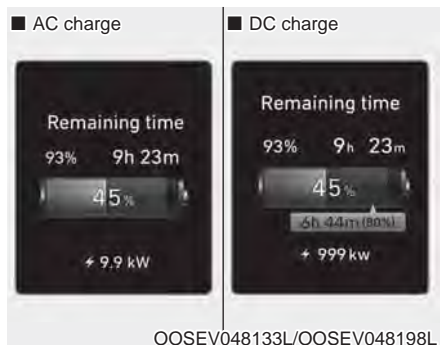

This message is displayed to notify the remaining time to charge the battery to the selected target battery charge level.

Unplug vehicle to start



This message is displayed when you start the vehicle without unplugging the charging cable. Unplug the charging cable, and then turn on the vehicle.

Charging door open



This message is displayed when the vehicle is driven with the charging door opened. Close the charging door and then start driving.

***Charging stopped.
Check the AC/DC charger***

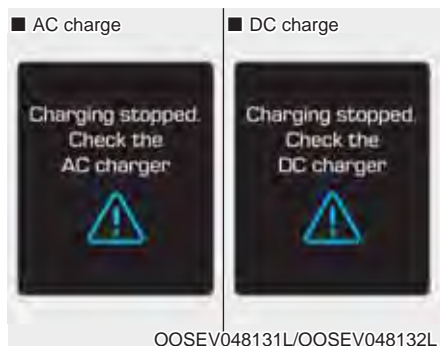

• This warning message is displayed when charging is stopped for the reasons below:

- There is a problem with the external AC charger or DC charger
- The external AC charger stopped charging
- The charging cable is damaged

In this case, check whether there is any problem with the external AC or DC charger and charging cable.

If the same problem occurs when charging the vehicle with a normally operating AC charger or genuine HYUNDAI portable charger, we recommend that you have your vehicle inspected by an authorized HYUNDAI dealer.

***Charging stopped.
Check the cable connection***



This warning message is displayed when charging is stopped because the charging connector is not correctly connected to the charging inlet

In this case, separate the charging connector and re-connect it and check whether there is any problem (external damage, foreign substances, etc.) with the charging connector and charging inlet.

If the same problem occurs when charging the vehicle with a replaced charging cable or genuine HYUNDAI portable charger, we recommend that you have your vehicle inspected by an authorized HYUNDAI dealer.

Check regenerative brakes / Stop vehicle and check brakes

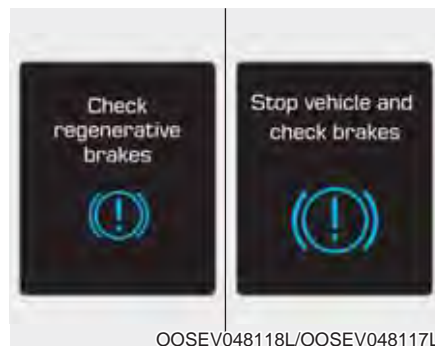

This warning message is displayed when the regenerative brake system does not work properly.

In this case, we recommend that you have the vehicle inspected by an authorized HYUNDAI dealer.

Low battery

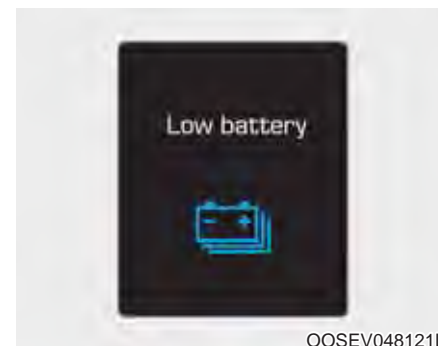

When the high voltage battery level reaches below approximately 8%, this warning message is displayed.

The warning light on the instrument cluster (⚠️) will turn ON simultaneously.

Charge the high voltage battery immediately.

**Charge immediately.
Power limited**



When the high voltage battery level reaches below approximately 3%, this warning message is displayed.

The warning light on the instrument cluster (🔋) and the power down warning light (⊖) will turn on simultaneously.

The vehicle's power will be reduced to minimize the energy consumption of the high voltage battery. Charge the battery immediately.

**Low outside temp. may limit
power output. Charge EV
battery/Low battery temperature.
Power limited**

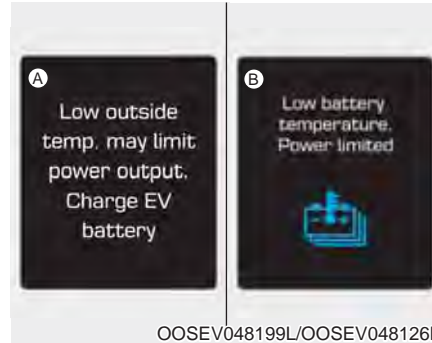

[A] : Displays when turning off vehicle.

[B] : Displays when turning on vehicle.

Both warning messages are displayed to protect electric vehicle system when outside temperature is low. If the high voltage battery charging level is low and parked outside in low temperature for a long time, vehicle power could be limited.

Charging the battery before driving helps increase power.

NOTICE

If this warning message is still displayed even after the ambient temperature has increased, we recommend that you have the vehicle inspected by an authorized HYUNDAI dealer.

Battery overheated! Stop safely



This warning message is displayed to protect battery and electric vehicle system when the high voltage battery temperature is too high.

Turn off the START/STOP button and stop the vehicle so that the battery temperature decreases.

Power limited



In the following cases, this warning message is displayed when the vehicle's power is limited for safety.

- When the high voltage battery is below a certain level, or voltage is decreasing.
- When the temperature of the motor or high voltage battery is very high.
- When there is a problem with the cooling system or a failure that may interrupt normal driving.

NOTICE

- When this warning message is displayed, do not accelerate or start the vehicle suddenly.
- When the power is limited for the safety of the high-powered parts of an electric vehicle, the warning message is displayed. Your vehicle may not be driven, or may roll back on a slope with the warning message displayed due to the limitation of vehicle power.

Stop safely and check power supply



This warning message is displayed when a failure occurs in the power supply system.

In this case, park the vehicle in a safe location and we recommend that you tow your vehicle to the nearest authorized HYUNDAI dealer and have the vehicle inspected.

Check Active Air Flap System



This warning message is displayed in the following situations:

- There is a malfunction with the actuator flap
- There is a malfunction with the actuator air flap controller
- The air flap does not open

When all of the above conditions are fixed, the warning will disappear.

Check virtual engine sound system



This message is displayed when there is a problem with the Virtual Engine Sound System (VESS).

In this case, we recommend that you have the vehicle inspected by an authorized HYUNDAI dealer.

Check electric vehicle system



This warning message is displayed when there is a problem with the electric vehicle control system.

Refrain from driving when the warning message is displayed.

In this case, we recommend that you have the vehicle inspected by an authorized HYUNDAI dealer.

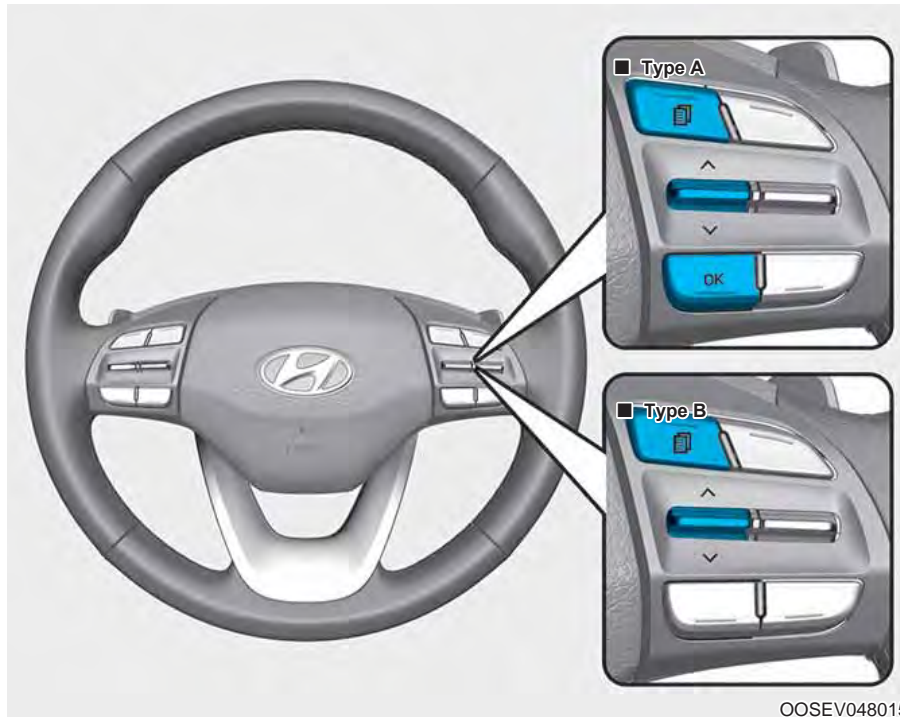

LCD DISPLAY

LCD display control







OOSEV048015

The LCD display modes can be changed by using the control buttons.

- (1)  : MODE button for changing modes
- (2)  ,  : MOVE switch for changing items
- (3) OK : SELECT/RESET button for setting or resetting the selected item

LCD display modes

Modes	Symbol	Explanation
Trip Computer		This mode displays driving information like the tripmeter, energy consumption, etc. For more details, refer to "Trip Computer" in this chapter.
Turn By Turn (TBT) (if equipped)		This mode displays the state of the navigation.
Assist		This mode displays the state of : - Tire Pressure For more details, refer to "Tire Pressure Monitoring System (TPMS)" in chapter 6.
User Settings		The User Settings mode provides user options for a variety of settings including door lock/unlock features, convenience features, driver assistance settings, etc.
Warning		The Master Warning mode displays warning messages related to the vehicle when one or more systems is not operating normally.

The information provided may differ depending on which functions are applicable to your vehicle.

Trip computer mode



The trip computer mode displays information related to vehicle driving parameters including energy consumption, trip meter information and vehicle speed.

For more details, refer to "Trip Computer" in this chapter.

Turn By Turn (TBT) mode



This mode displays the state of the navigation.



Tire Pressure

This mode displays information related to Tire Pressure.

For more details, refer to "Tire Pressure Monitoring System (TPMS)" in chapter 6.

Master warning mode

This warning informs the driver the following situations.

- LED headlamp malfunction (if equipped)
- Lamp malfunction
- Tire Pressure Monitoring System (TPMS) malfunction

The Master Warning Light illuminates if one or more of the above warning situations occur. At this time, the LCD Modes Icon will change from (⚙️) to (⚠️).

If the warning situation is solved, the master warning light will be turned off and the LCD Modes Icon will be changed back to its previous icon (⚙️).

User settings mode



In this mode, you can change the settings of the instrument cluster, doors, lamps, etc.

1. Door
2. Lights
3. Sound
4. Convenience
5. Service interval
6. Other features
7. Utility mode
8. Language
9. Reset



Shift to P to edit settings

This warning message appears if you try to adjust the User Settings while driving.

For your safety, change the User Settings after parking the vehicle, applying the parking brake and shifting to P (Park).

Quick guide help

This mode provides quick guides for the systems in the User Settings mode.

Select an item, press and hold the OK button.

For more details, about each system, refer to this Owner's Manual.

1. Door

Items	Explanation
Auto lock	<ul style="list-style-type: none"> - Disable: The auto door lock operation will be canceled. - Enable on speed: All doors will be automatically locked when the vehicle speed exceeds 15 km/h (9.3 mph). - Enable on shift: All doors will be automatically locked if the vehicle is shifted from the P (Park) position to the R (Reverse), N (Neutral), or D (Drive) position.
Auto unlock	<ul style="list-style-type: none"> - Disable: The auto door unlock operation will be canceled. - Vehicle Off: All doors will be automatically unlocked when the START/STOP button is set to the OFF position. - On shift to P: All doors will be automatically unlocked if the gear is shifted to the P (Park) position.
Two press unlock	<ul style="list-style-type: none"> - Off: The two press unlock function will be deactivated. Therefore, all doors will unlock if the door unlock button is pressed. - On: Only the driver's door will unlock if the door unlock button is pressed. When the door unlock button is pressed again within 4 seconds, the remaining doors will unlock.

✱ The information provided may differ depending on which functions are applicable to your vehicle.

2. Lights

Items	Explanation
One touch turn indicator	- Off: The one touch turn signal function will be deactivated. - 3, 5, 7 Flashes: The turn signal indicator will blink 3, 5, or 7 times when the turn signal lever is moved slightly. For more details, refer to "Lighting" in this chapter.
Head lamp delay	To activate or deactivate the headlight delay function. For more details, refer to "Lighting" in this chapter.

3. Sound

Items	Explanation
Volume for PDW (Parking Distance Warning)	To adjust the Parking Distance Warning system volume. - Level 1 / Level 2 / Level 3

✱ The information provided may differ depending on which functions are applicable to your vehicle.

4. Convenience

Items	Explanation
Welcome mirror	To activate or deactivate the welcome mirror function. When activated, the outside rearview mirrors are unfolded if approached with the smart key. For more details, refer to "Outside Rearview Mirror" in this chapter.
Wireless charging system	To activate or deactivate the wireless charging system in the front seat. For more details, refer to "Wireless Cellular Phone Charging System" in this chapter.
Wiper/Lights display	To activate or deactivate the Wiper/Light mode. When activated, the LCD display shows the selected Wiper/Light mode whenever you change the mode.
Auto rear wiper (reverse)	To activate or deactivate the rear wiper while the vehicle is in reverse with the front wiper ON.
Gear position pop-up	To activate or deactivate the gear position pop-up. When activated, the gear position will be displayed in the cluster LCD display.
Smart recuperation	To activate or deactivate the Smart Recuperation function. When activated, the recuperation level is adjusted automatically according to the current driving situation. For more details, refer to "Smart Recuperation System" in chapter 5.
Icy road warning	To activate or deactivate the Icy Road Warning function.

※ The information provided may differ depending on which functions are applicable to your vehicle.

5. Service interval

Items	Explanation
Service interval	To activate or deactivate the service interval function.
Adjust interval	If the service interval menu is activated, you may adjust the time and distance.

If the service interval is activated and the time and distance is adjusted, messages are displayed in the following situations each time the vehicle is turned on.

- Service in: Displayed to inform the driver the remaining mileage and days to service.
- Service required: Displayed when the mileage and days to service has been reached or passed.

Information

If any of the following conditions occur, the mileage and number of days to service may be incorrect.

- **The battery cable is disconnected.**
- **The fuse switch is turned off.**
- **The battery is discharged.**

※ The information provided may differ depending on which functions are applicable to your vehicle.

6. Other features

Items	Explanation
Aux. Battery Saver+	<p>To activate or deactivate the Aux. Battery Saver+ function. When activated, the high voltage battery is used to keep the 12V battery charged.</p> <p>For more details, refer to “Aux. Battery Saver+” in the Electric Vehicle Guide in front of the owner’s manual.</p>
Energy consumption auto reset	<ul style="list-style-type: none"> - Off: The average energy consumption will not reset automatically. - After ignition: The average energy consumption will reset automatically whenever it has passed 4 hours after turning OFF the vehicle. - After recharging : The energy consumption will reset automatically after recharging. <p>For more details, refer to "Trip Computer" in this chapter.</p>
Speedometer subscale	<p>To activate or deactivate the display of a secondary speedometer. When activated, it is displayed underneath the main speedometer.</p> <p>For more details, refer to “Gauges and Meters” in this chapter.</p>
Consumption unit	<p>To select the fuel economy unit.</p> <ul style="list-style-type: none"> - km/kWh / kWh/100km
Temperature unit	<p>To select the temperature unit.</p> <ul style="list-style-type: none"> - °C / °F
Tire pressure unit	<p>To select the tire pressure unit.</p> <ul style="list-style-type: none"> - psi / kPa / bar

✱ The information provided may differ depending on which functions are applicable to your vehicle.

7. Utility mode

Items	Explanation
Switch to utility mode?	To activate the utility mode. When activated, electric devices in the vehicle is operated using the high voltage battery. For more details, refer to “Utility Mode” in the Electric Vehicle Guide in front of the owner's manual.

8. Language

Items	Explanation
Language	To select language.

9. Reset

Items	Explanation
Reset	You can reset the menus in the User Settings mode. All menus in the User Settings mode are reset to factory settings, except language and service interval.

✳ The information provided may differ depending on which functions are applicable to your vehicle.

TRIP COMPUTER

The trip computer is a microcomputer-controlled driver information system that displays information related to driving.

i Information

Some driving information stored in the trip computer resets if the battery is disconnected.

Trip modes

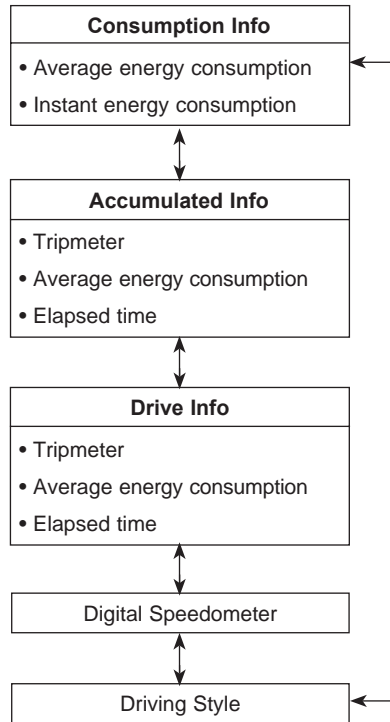

To change the trip mode, toggle the “^, v” switch on the steering wheel.

Consumption info display



Average energy consumption (1)

- The average energy consumption is calculated by the total driving distance and the high voltage battery consumption since the last average energy consumption reset.
- The average energy consumption can be reset both manually and automatically.

Manual reset

To clear the average energy consumption manually, press the OK button on the steering wheel for more than 1 second when the average energy consumption is displayed.

Automatic reset

To automatically reset the average energy consumption select either menu from the 'Energy consumption auto reset' in the User Settings mode on the LCD display.

- After ignition: The average energy consumption will reset automatically whenever it has passed 4 hours after turning OFF the vehicle.
- After recharging: The average energy consumption will reset automatically when driving speed exceeds 1 km/h, after recharging more than 10%.

Instant energy consumption (2)

- This mode displays the instantaneous energy consumption while driving.

Accumulated info display

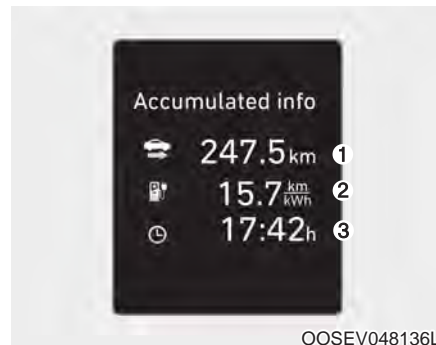

This display shows the accumulated trip distance (1), the average energy consumption (2), and the total driving time (3).

The information is accumulated starting from the last reset.

To manually reset the information, press and hold the OK button when viewing the Accumulated driving info. The trip distance, the average energy consumption, and total driving time will reset simultaneously.

The accumulated driving information will continue to be counted while the vehicle is in the ready (🚗) mode (for example, when the vehicle is in traffic or stopped at a stop light).

i Information

The vehicle must be driven for a minimum of 300 meters (0.19 miles) since the last ignition key cycle before the accumulated driving information is recalculated.

Drive Info display



This display shows the trip distance (1), the average energy consumption (2), and the total driving time (3).

The information is combined for each ignition cycle. However, when the vehicle has been OFF for 4 hours or longer the Drive Info screen will reset.

To manually reset the information, press and hold the OK button when viewing the Drive Info. The trip distance, the average energy consumption, and total driving time will reset simultaneously.

The driving information will continue to be counted while the vehicle is in the ready (🚗) mode (for example, when the vehicle is in traffic or stopped at a stop light.)

i Information

The vehicle must be driven for a minimum of 300 meters (0.19 miles) since the last ignition key cycle before the driving information is recalculated.

Digital speedometer



This digital speedometer display shows the speed of the vehicle (km/h, MPH).

Energy flow



The electric vehicle system informs the drivers its energy flow in various operating modes. While driving, the current energy flow is specified in 3 modes.

For more details, refer to “Energy Flow” in the Electric Vehicle Guide provided in front of the owner’s manual.

Driving style



This display shows whether the driver's driving style is Economical(1), Normal (2) or Aggressive (3).

LIGHTING

Exterior lights

Lighting control

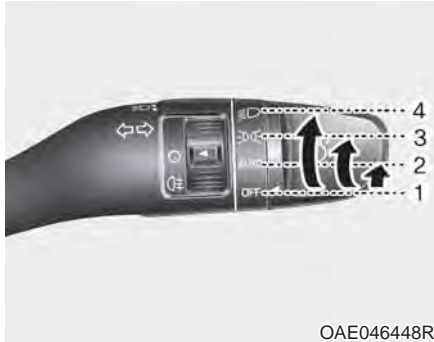

To operate the lights, turn the knob at the end of the control lever to one of the following positions:

- (1) OFF (O)
- (2) AUTO light
- (3) Position lamp
- (4) Headlamp



AUTO light

When the light switch is in the AUTO position, the position lamp and headlamp will be turned ON or OFF automatically depending on the amount of light outside the vehicle.

Even with the AUTO light feature in operation, it is recommended to manually turn ON the lamps when driving at night or in a fog, or when you enter dark areas, such as tunnels and parking facilities.

NOTICE

- Do not cover or spill anything on the sensor (1) located on the instrument panel.
- Do not clean the sensor using a window cleaner, the cleanser may leave a light film which could interfere with sensor operation.
- If your vehicle window is tinted or other types of metallic coating are on the front windshield, the AUTO light system may not work properly.

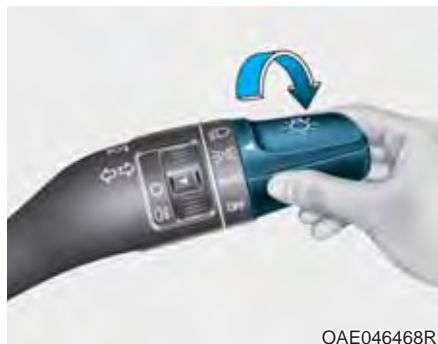

Position lamp (☞☞☞)

The position lamp, license plate lamp and instrument panel lamp are turned ON.



Headlamp (☞☞)

The headlamp, position lamp, license plate lamp and instrument panel lamp are turned ON.

i Information

The START/STOP button must be in the ON position to turn on the headlamp.

High beam operation



To turn on the high beam headlamp, push the lever away from you. The lever will return to its original position.

The high beam indicator will light when the headlamp high beams are switched on.

To turn off the high beam headlamp, pull the lever towards you. The low beams will turn on.

⚠ WARNING

Do not use high beam when there are other vehicles approaching you. Using high beam could obstruct the other driver's vision.

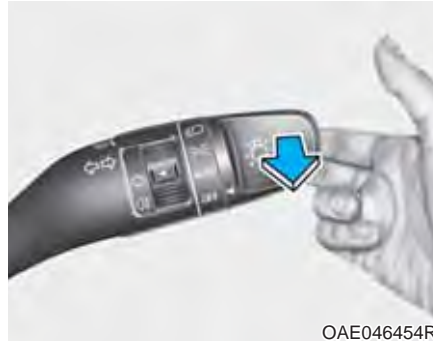

OAE046454R

To flash the high beam headlamp, pull the lever towards you, then release the lever. The high beams will remain ON as long as you hold the lever towards you.

Turn signals and lane change signals



OAE046456R

To signal a turn, push down on the lever for a left turn or up for a right turn in position (A). To signal a lane change, move the turn signal lever slightly and hold it in position (B).

The lever will return to the OFF position when released or when the turn is completed.

If an indicator stays on and does not flash or if it flashes abnormally, one of the turn signal bulbs may be burned out and will require replacement.

One-touch turn signal function

To activate an one-touch turn signal function, move the turn signal lever slightly and then release it. The lane change signals will blink 3, 5 or 7 times.

You can activate or deactivate the One Touch Turn Signal function or choose the number of blinking (3, 5, or 7) from the User Settings Mode on the LCD display. **For more details, refer to "LCD Display Modes" in this chapter.**

Rear fog lamp



To turn on the rear fog lamp:

Position the light switch in the headlamp position, and then turn the light switch (1) to the rear fog lamp position.

To turn the rear fog lamps off, do one of the following:

- Turn off the headlamp switch.
- Turn the light switch to the rear fog lamp position again.

Battery saver function

The purpose of this feature is to prevent the battery from being discharged. The system automatically turns off the position lamp when the driver turns the vehicle off and opens the driver-side door.

With this feature, the position lamps will turn off automatically if the driver parks on the side of road at night.

If necessary, to keep the lamps on when the vehicle is turned off, perform the following:

- 1) Open the driver-side door.
- 2) Turn the position lamps OFF and ON again using the light switch on the steering column.

Headlamp delay function (if equipped)

If you place the START/STOP button to the ACC or OFF position with the headlamps ON, the headlamps (and/or position lamps) remain on for about 5 minutes. However, with the vehicle off if the driver's door is opened and closed, the headlamps (and/or position lamps) are turned off after 15 seconds.

The headlamps (and/or position lamps) can be turned off by pressing the lock button on the smart key twice or turning the light switch to the OFF or AUTO position. However, if you turn the light switch to the AUTO position when it is dark outside, the headlamps will not be turned off.

You can activate or deactivate the Headlamp Delay function from the User Settings Mode in the LCD display. **For more details, refer to "LCD Display Modes" in this chapter.**

NOTICE

If the driver exits the vehicle through another door besides the driver door, the battery saver function does not operate and the headlamp delay function does not turn OFF automatically.

This may cause the battery to discharge. To avoid battery discharge, turn OFF the headlamps manually from the headlamp switch before exiting the vehicle.

Daytime running light (DRL)

The Daytime Running Lights (DRL) can make it easier for others to see the front of your vehicle during the day, especially after dawn and before sunset.

The DRL system will turn the dedicated lamp OFF when:

1. The headlamps are in the ON position.
2. The vehicle is turned off.

Headlight leveling device



Manual type

To adjust the headlight beam level according to the number of the passengers and loading weight in the luggage area, turn the beam leveling switch.

The higher the number of the switch position, the lower the headlight beam level. Always keep the headlight beam at the proper leveling position, or headlights may dazzle other road users.

Listed below are examples of appropriate switch settings for varying loads. For loading conditions other than those listed, adjust the switch position to the most similar situation.

Loading condition	Switch position
Driver only	0
Driver + Front passenger	0
Full passengers (including driver)	1
Full passengers (including driver) + Maximum permissible loading	2
Driver + Maximum permissible loading	3

Automatic type

It automatically adjusts the headlamp beam level according to the number of passengers and loading weight in the luggage area.

It also adjusts to the appropriate headlamp beam level for various situations.

⚠ WARNING

If the function does not work properly, we recommend that the system be inspected by an authorized HYUNDAI dealer. Do not attempt to inspect or replace the wiring yourself.

Low Beam Assist-Static light (if equipped)

While driving a corner, for greater visibility and safety, either the left or right side Low Beam Assist-Static light will turn on automatically.

Welcome system (if equipped)

Headlamp and position lamp

When the headlamp (lamp switch in the headlamp or AUTO position) is on and all doors (and tailgate) are locked and closed, the position lamp and headlamp will come on for 15 seconds when the door unlock button is pressed on the smart key.

At this time, if you press the door lock or unlock button, the position lamp and headlamp will turn off immediately.

Interior lamp

When the interior lamp switch is in the DOOR position and all doors (and tailgate) are closed and locked, the room lamp will come on for 30 seconds if any of the below is performed.

- When the door unlock button is pressed on the smart key.
- When the button of the outside door handle is pressed.

At this time, if you press the door lock or unlock button, the room lamp will turn off immediately.

Interior lights

NOTICE

Do not use the interior lights for extended periods when the vehicle is turned off or the battery will discharge.

Interior lamp AUTO cut

The interior lamps will automatically go off approximately 20 minutes after the vehicle is turned off and the doors closed. If a door is opened, the lamp will go off 40 minutes after the vehicle is turned off. If the doors are locked by the smart key and the vehicle enters the armed stage of the theft alarm system, the lamps will go off five seconds later.

Front lamps

■ Type A



■ Type B



Front Map Lamp (1) :

Press either of these lens to turn the map lamp on or off. This light produces a spot beam for convenient use as a map lamp at night or as a personal lamp for the driver and the front passenger.

Front Door Lamp () (2) :

The front or rear room lamps come on when the front or rear doors are opened. When doors are unlocked by the smart key, the front and rear lamps come on for approximately 30 seconds as long as any door is not opened. The front and rear room lamps go out gradually after approximately 30 seconds if the door is closed. However, if the START/STOP button is in the ON position or all doors are locked, the front and rear lamps will turn off. If a door is opened with the START/STOP button in the ACC position or the OFF position, the front and rear lamps stay on for about 20 minutes.

Front room lamp

-  (3) :

Press the button to turn ON the room lamp for the front/rear seats.

-  (4) :

Press the button to turn OFF the room lamp for the front/rear seats.

Rear lamps

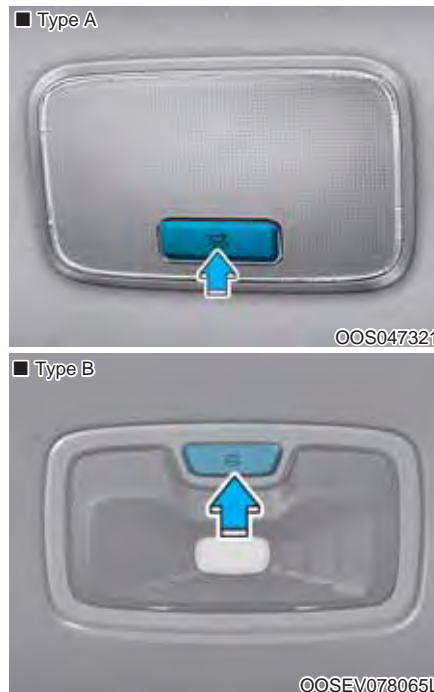

Rear Room Lamp Switch ():

Press this button to turn the room lamp on and off.

NOTICE

Do not leave the lamp switches on for an extended period of time when the vehicle is turned off.

Vanity mirror lamp



Push the switch to turn the light on or off.

- ☀️ : The lamp will turn on if this button is pressed.
- ○ : The lamp will turn off if this button is pressed.

NOTICE

Always have the switch in the off position when the vanity mirror lamp is not in use. If the sunvisor is closed without the lamp off, it may discharge the battery or damage the sunvisor.

Luggage compartment lamp



The luggage compartment lamp comes on when the tailgate is opened.

NOTICE

The luggage compartment lamp comes on as long as the tailgate is open. To prevent unnecessary charging system drain, close the tailgate securely after using the tailgate.

WIPERS AND WASHERS



A : Wiper speed control

- MIST – Single wipe
 - OFF – Off
 - AUTO – Auto control wipe (if equipped)
 - INT – Intermittent wipe
 - LO – Low wiper speed
 - HI – High wiper speed
- * : if equipped

B : Auto control wipe time adjustment

C : Wash with brief wipes (front) (pull lever towards you)

D : Rear wiper control*

- HI – High wiper speed
- LO – Low wiper speed
- OFF – Off

E : Wash with brief wipes (rear) (push lever away from you)

* : if equipped

Front windshield wipers

Operates as follows when the START/STOP button is in the ON position.

MIST : For a single wiping cycle, push the lever upward (or downward) and release. The wipers will operate continuously if the lever is held in this position.

OFF : Wiper is not in operation.

INT : Wiper operates intermittently at the same wiping intervals. To vary the speed setting, turn the speed control knob (B).

AUTO : The rain sensor located on the upper end of the windshield glass senses the amount of rainfall and controls the wiping cycle for the proper interval. The more it rains, the faster the wiper operates. When the rain stops, the wiper stops. To vary the speed setting, turn the speed control knob (B).

LO : The wiper runs at a lower speed.

HI : The wiper runs at a higher speed.

Information

If there is heavy accumulation of snow or ice on the windshield, defrost the windshield for about 10 minutes, or until the snow and/or ice is removed before using the windshield wipers to ensure proper operation.

If you do not remove the snow and/or ice before using the wiper and washer, it may damage the wiper and washer system.

AUTO (Automatic) control

The rain sensor located on the upper end of the windshield glass senses the amount of rainfall and controls the wiping cycle for the proper interval. The wiper operation time will be automatically controlled depends on rainfall.

When the rain stops, the wiper stops. To vary the speed setting, turn the speed control knob (1).

If the wiper switch is set in AUTO mode when the START/STOP button is in the ON position, the wiper will operate once to perform a self-check of the system. Set the wiper to OFF position when the wiper is not in use.

WARNING

To avoid personal injury from the windshield wipers, when the vehicle is in the ready () mode and the windshield wiper switch is placed in the AUTO mode:

- Do not touch the upper end of the windshield glass facing the rain sensor.
- Do not wipe the upper end of the windshield glass with a damp or wet cloth.
- Do not put pressure on the windshield glass.

NOTICE

- When washing the vehicle, set the wiper switch in the OFF position to stop the auto wiper operation. The wiper may operate and be damaged if the switch is set in the AUTO mode while washing the vehicle.
- Do not remove the sensor cover located on the upper end of the passenger side windshield glass. Damage to system parts could occur and may not be covered by your vehicle warranty.

Front windshield washers



In the OFF position, pull the lever gently toward you to spray washer fluid on the windshield and to run the wipers 1-3 cycles. The spray and wiper operation will continue until you release the lever. If the washer does not work, you may need to add washer fluid to the washer fluid reservoir.

⚠ WARNING

When the outside temperature is below freezing, **ALWAYS** warm the windshield using the defroster to prevent the washer fluid from freezing on the windshield and obscuring your vision which could result in an accident and serious injury or death.

CAUTION

- To prevent possible damage to the washer pump, do not operate the washer when the fluid reservoir is empty.
- To prevent possible damage to the wipers or windshield, do not operate the wipers when the windshield is dry.
- To prevent damage to the wiper arms and other components, do not attempt to move the wipers manually.
- To prevent possible damage to the wipers and washer system, use anti-freezing washer fluids in the winter season or cold weather.

Rear window wiper and washer switch (if equipped)



The rear window wiper and washer switch is located at the end of the wiper and washer switch lever.

Turn the switch to the desired position to operate the rear wiper and washer.

HI (2) – High wiper speed

LO (1) – Low wiper speed

OFF (O) – Off



Push the lever away from you to spray rear washer fluid and to run the rear wipers 1~3 cycles. The spray and wiper operation will continue until you release the lever (if equipped).

Auto rear wiper (if equipped)

The rear wiper will operate while the vehicle is in reverse with the front wiper ON by selecting the function on the LCD display.

Go to 'User Settings → Convenience → Auto rear wiper (reverse)'.

DRIVER ASSIST SYSTEM

Rear view monitor (if equipped)



The Rear View Monitor will activate when the vehicle is in the ready (🚗) mode and the gear is in the R (Reverse) position.

This is a supplemental system that shows behind the vehicle through the audio or infotainment system screen while backing-up.

⚠️ WARNING

The Rear View Monitor is not a safety device. It only serves to assist the driver in identifying objects directly behind the middle of the vehicle. The camera does NOT cover the complete area behind the vehicle.

⚠️ WARNING

- Never rely solely on the rear camera display when backing-up.
- ALWAYS look around your vehicle to make sure there are no objects or obstacles before moving the vehicle in any direction to prevent a collision.
- Always pay close attention when the vehicle is driven close to objects, particularly pedestrians, and especially children.

NOTICE

- Do not spray the camera or its surrounding area directly with a high pressure washer. Shock applied from high pressure water may cause the device to not operate normally.
- Do not use any cleanser containing acid or alkaline detergents when cleaning the lens. Use only a mild soap or neutral detergent, and rinse thoroughly with water.

i Information

Always keep the camera lens clean. The camera may not work normally if the lens is covered with dirt, water or snow.

However, do not use chemical solvents such as strong detergents containing high alkaline or volatile organic solvents (gasoline, acetone etc.). This may damage the camera lens.

Parking Distance Warning (Reverse) system



[B] : Sensor

The Parking Distance Warning (Reverse) system assists the driver during reverse movement of the vehicle by chiming if any object is sensed within the distance of 120 cm (50 inches) behind the vehicle.

This system is a supplemental system that senses objects within the range and location of the sensors, it cannot detect objects in other areas where sensors are not installed.

⚠ WARNING



- **ALWAYS** look around your vehicle to make sure there are not any objects or obstacles before moving the vehicle in any direction to prevent a collision.
- Always pay close attention when the vehicle is driven close to objects, particularly pedestrians, and especially children.
- Be aware that some objects may not be visible on the screen or be detected by the sensors, due to the objects distance, size or material, all of which can limit the effectiveness of the sensor.

Operation of the Parking Distance Warning (Reverse) system

Operating condition

- This system will activate when backing up with the START/STOP button in the ON position. However, if vehicle speed exceeds 5 km/h (3 mph), the system may not detect objects.
- If vehicle speed exceeds 10 km/h (6 mph), the system will not warn you even though objects are detected.
- When more than two objects are sensed at the same time, the closest one will be recognized first.

Types of warning sound and indicator

Types of warning sound	Indicator
When an object is 120 cm to 60 cm (47 in. to 24 in.) from the rear bumper : Buzzer beeps intermittently.	
When an object is 60 cm to 30 cm (24 in. to 12 in.) from the rear bumper : Buzzer beeps more frequently.	
When an object is within 30 cm (12 in.) of the rear bumper : Buzzer beeps continuously.	

NOTICE

- The indicator may differ from the illustration depending on objects or sensors status. If the indicator blinks, we recommend that you have your vehicle checked by an authorized HYUNDAI dealer.
- If the audible warning does not sound or if the buzzer sounds intermittently when shifting into R (Reverse) position, this may indicate a malfunction with Parking Distance Warning (Reverse) system. If this occurs, we recommend that you have your vehicle checked by an authorized HYUNDAI dealer as soon as possible.

To turn off the Parking Distance Warning (Reverse) system (if equipped)



Push the button to turn off the Parking Distance Warning (Reverse) system. The indicator light on the button will turn on.

Non-operational conditions of Parking Distance Warning (Reverse) system

The Parking Distance Warning (Reverse) system may not operate normally when:

- Moisture is frozen to the sensor.
- Sensor is covered with foreign matter, such as snow or water, or the sensor cover is blocked.

There is a possibility of the Parking Distance Warning (Reverse) system malfunction when:

- Driving on uneven road surfaces such as unpaved roads, gravel, bumps, or gradient.
- Objects generating excessive noise such as vehicle horns, loud motorcycle engines, or truck air brakes can interfere with the sensor.
- Heavy rain or water spray is present.
- Wireless transmitters or mobile phones are present near the sensor.
- The sensor is covered with snow.
- Any non-factory equipment or accessories have been installed, or if the vehicle bumper height or sensor installation has been modified.

Detecting range may decrease when:

- Outside air temperature is extremely hot or cold.
- Undetectable objects smaller than 1 m (40 inches) and narrower than 14 cm (6 inches) in diameter.

The following objects may not be recognized by the sensor:

- Sharp or slim objects such as ropes, chains or small poles.
- Objects, which tend to absorb sensor frequency such as clothes, spongy material or snow.

⚠ WARNING

Your new vehicle warranty does not cover any accidents or damage to the vehicle or injuries to its occupants related to a Parking Distance Warning (Reverse) system. Always drive safely and cautiously.

Parking Distance Warning (Reverse) system precautions

- The Parking Distance Warning (Reverse) system may not sound consistently depending on the speed and shapes of the objects detected.
- The Parking Distance Warning (Reverse) system may malfunction if the vehicle bumper height or sensor installation has been modified or damaged. Any non-factory installed equipment or accessories may also interfere with the sensor performance.
- The sensor may not recognize objects less than 30 cm (11 in.) from the sensor, or it may sense an incorrect distance. Use caution.
- When the sensor is frozen or stained with snow, dirt, or water, the sensor may be inoperative until the stains are removed using a soft cloth.
- Do not push, scratch or strike the sensor with any hard objects that could damage the surface of the sensor. Sensor damage could occur.

- Do not spray the sensors or its surrounding area directly with a high pressure washer. Shock applied from high pressure water may cause the device to not operate normally.

Parking Distance Warning (Reverse/Forward) system (if equipped)



[A] : Front Sensor, [B] : Rear Sensor

The Parking Distance Warning (Reverse/Forward) system assists the driver during movement of the vehicle by chiming if any object is sensed within the distance of 100 cm (39 inches) in front and 120 cm (47 inches) behind the vehicle.

This system is a supplemental system that senses objects within the range and location of the sensors, it cannot detect objects in other areas where sensors are not installed.

⚠ WARNING

- **ALWAYS** look around your vehicle to make sure there are no objects or obstacles before moving the vehicle in any direction to prevent a collision.
- Always pay close attention when the vehicle is driven close to objects, particularly pedestrians, and especially children.
- Be aware that some objects may not be visible on the screen or be detected by the sensors, due to the objects distance, size or material, all of which can limit the effectiveness of the sensor.

Operation of the Parking Distance Warning (Reverse/Forward) system









Operating condition

- This system will activate when the Parking Distance Warning (Reverse/ Forward) system button is pressed with the vehicle in the ready (🚗) mode.

- The Parking Distance Warning (Reverse/Forward) system button turns on automatically and activates the Parking Distance Warning (Reverse/Forward) system when the gear is in R (Reverse) position. However, if vehicle speed exceeds 10 km/h (6 mph), the system will not warn you even though objects are detected, and if vehicle speed exceeds 20 km/h (12 mph), the system will turn off automatically. To turn on the system, press the Parking Distance Warning (Reverse/Forward) system button.
- When more than two objects are sensed at the same time, the closest one will be recognized first.

Types of warning sound and indicator

cm (in)

Distance from object		Warning indicator		Warning sound
		When driving forward	When driving rearward	
61 ~ 100 (24 ~39)	Front		-	Buzzer beeps intermittently
61 ~ 120 (24 ~47)	Rear	-		Buzzer beeps intermittently
31 ~ 60 (12 ~24)	Front			Buzzer beeps frequently
	Rear	-		Buzzer beeps frequently
30 (12)	Front			Buzzer sounds continuously
	Rear	-		Buzzer sounds continuously

NOTICE

- The indicator may differ from the illustration depending on objects or sensors status. If the indicator blinks, we recommend that the system be checked by an authorized HYUNDAI dealer.
- If the audible warning does not sound or if the buzzer sounds intermittently when shifting into R (Reverse) position, this may indicate a malfunction with the Parking Distance Warning (Reverse/Forward) system. If this occurs, we recommend that you have your vehicle checked by an authorized HYUNDAI dealer as soon as possible.

Non-operational conditions of Parking Distance Warning (Reverse/Forward) system

Parking Distance Warning (Reverse/Forward) system may not operate normally when:

- Moisture is frozen to the sensor.
- Sensor is covered with foreign matter, such as snow or water, or the sensor cover is blocked.

There is a possibility of Parking Distance Warning (Reverse/Forward) system malfunction when:

- Driving on uneven road surfaces such as unpaved roads, gravel, bumps, or gradient.
- Objects generating excessive noise such as vehicle horns, loud motorcycle engines, or truck air brakes can interfere with the sensor.
- Heavy rain or water spray is present.
- Wireless transmitters or mobile phones are present near the sensor.
- The sensor is covered with snow.
- Any non-factory equipment or accessories have been installed, or if the vehicle bumper height or sensor installation has been modified.

Detecting range may decrease when:

- Outside air temperature is extremely hot or cold.
- Undetectable objects smaller than 1 m and narrower than 14 cm in diameter.

The following objects may not be recognized by the sensor:

- Sharp or slim objects such as ropes, chains or small poles.
- Objects, which tend to absorb sensor frequency such as clothes, spongy material or snow.

⚠ WARNING

Your new vehicle warranty does not cover any accidents or damage to the vehicle or injuries to its occupants related to a Parking Distance Warning (Reverse/Forward) system. Always drive safely and cautiously.

Parking Distance Warning (Reverse/Forward) system precautions

- The Parking Distance Warning (Reverse/Forward) system may not sound consistently depending on the speed and shapes of the objects detected.
- The Parking Distance Warning (Reverse/Forward) system may malfunction if the vehicle bumper height or sensor installation has been modified or damaged. Any non-factory installed equipment or accessories may also interfere with the sensor performance.
- The sensor may not recognize objects less than 30 cm (11 in.) from the sensor, or it may sense an incorrect distance. Use caution.
- When the sensor is frozen or stained with snow, dirt, or water, the sensor may be inoperative until the stains are removed using a soft cloth.
- Do not push, scratch or strike the sensor. Sensor damage could occur.
- Do not spray the sensors or its surrounding area directly with a high pressure washer. Shock applied from high pressure water may cause the device to not operate normally.

AUTOMATIC CLIMATE CONTROL SYSTEM



1. Temperature control knob
2. Fan speed control knob
3. AUTO (automatic control) button
4. OFF button
5. Mode selection button
6. Air conditioning button
7. Climate control information screen selection button
8. Driver only button
9. Front windshield defroster button
10. Rear window defroster button
11. HEAT button
12. Air intake control button

OOSEV048300

Automatic heating and air conditioning



1. Press the AUTO button.

The modes, fan speeds, air intake and air-conditioning will be controlled automatically according to the temperature setting.



2. Turn the temperature control knob to set the desired temperature.

i Information

- To turn the automatic operation off, select any button of the following:
 - Mode selection button
 - Front windshield defroster button (Press the button one more time to deselect the front windshield defroster function. The 'AUTO' sign will illuminate on the information display once again.)
 - Fan speed control buttonThe selected function will be controlled manually while other functions operate automatically.
- For your convenience, use the AUTO button and set the temperature to 22°C (72°F).

i Information

To control the temperature of the high voltage battery while charging, the air conditioner is used to cool down the high-voltage battery which may generate noise from operation of the air conditioner compressor and cooling fan.

Also, the air conditioner's performance may be reduced during summer due to operation of the cooling system for the high voltage battery.





i Information

Never place anything near the sensor to ensure better control of the heating and cooling system.

Manual heating and air conditioning

The heating and cooling system can be controlled manually by pushing buttons other than the AUTO button. In this case, the system works sequentially according to the order of buttons selected. When pressing any button except the AUTO button while using automatic operation, the functions not selected will be controlled automatically.

1. Start the vehicle.
 2. Set the mode to the desired position.
For improving the effectiveness of heating and cooling;
 - Heating: 
 - Cooling: 
 3. Set the temperature control to the desired position.
 4. Set the air intake control to the outside (fresh) air position.
 5. Set the fan speed control to the desired speed.
 6. If air conditioning is desired, turn the air conditioning system on.
- Press the AUTO button in order to convert to full automatic control of the system.

Mode selection

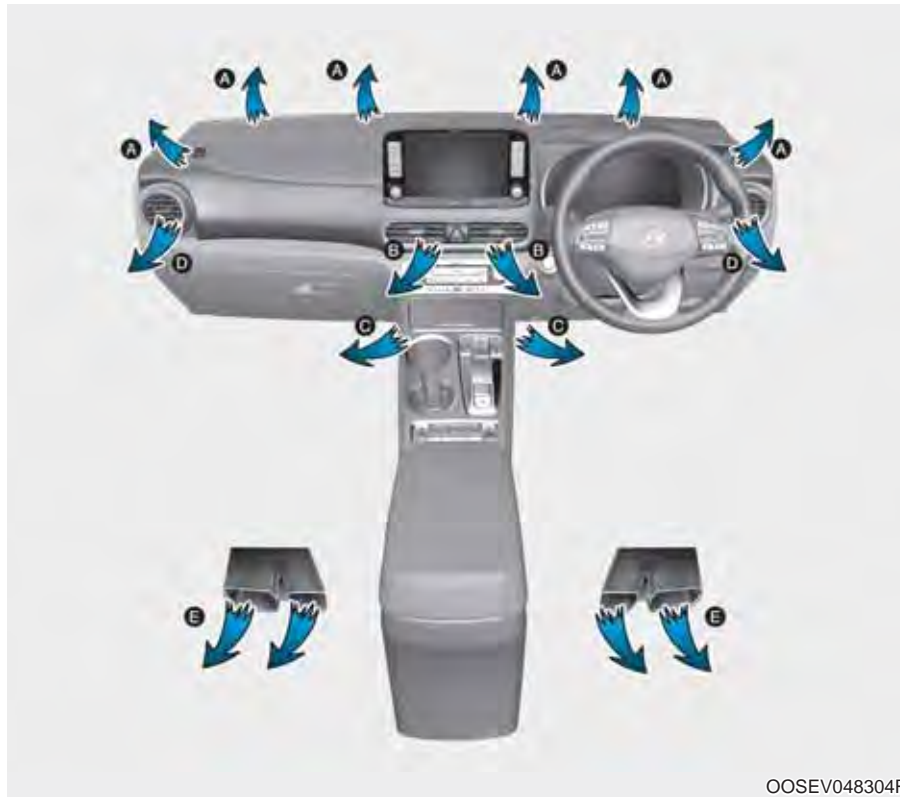

The mode selection button controls the direction of the air flow through the ventilation system.

The air flow outlet port is converted as follows:





Face-Level (B, D)

Air flow is directed toward the upper body and face. Additionally, each outlet can be controlled to direct the air discharged from the outlet.



Bi-Level (B, C, D, E)

Air flow is directed towards the face and the floor.



Floor & Defrost (A, C, D, E)

Most of the air flow is directed to the floor and the windshield with a small amount directed to the side window defrosters.



Floor-Level (A, C, D, E)

Most of the air flow is directed to the floor, with a small amount of the air being directed to the windshield and side window defrosters.

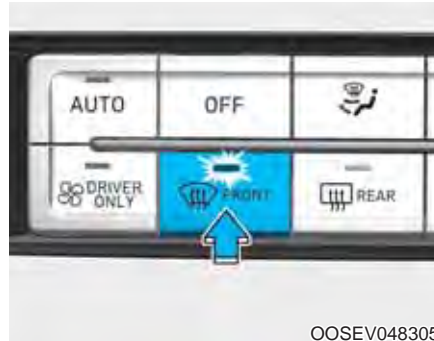

Defrost-Level (A)

Most of the air flow is directed to the windshield with a small amount of air directed to the side window defrosters.



Instrument panel vents

The outlet vents can be opened or closed (⊗) using the vent control lever.

Also, you can adjust the direction of air delivery from these vents using the vent control lever as shown.

Temperature control



The temperature will increase by turning the knob to the right. The temperature will decrease by turning the knob to the left.

The temperature will increase or decrease by 0.5°C (1°F) for each incremental location. When set to the lowest temperature setting, the air conditioning will operate continuously.

Temperature conversion

If the battery has been discharged or disconnected, the temperature mode display will reset to Centigrade.

To change the temperature unit from °C to °F or °F to °C :

- Automatic climate control system
Press the AUTO button for 3 seconds while pressing the OFF button.
- Instrument cluster
Go to User settings → Other features → Temperature unit.

The temperature unit on both the cluster LCD display and the climate control screen will change.

Air intake control



The air intake control button is used to select either Fresh mode (outside air) or Recirculation mode (cabin air).

Recirculation mode



When Recirculation mode is selected, air from the passenger compartment will be recirculated through the system and heated or cooled according to the function selected.

Fresh mode



When Fresh mode is selected, air enters the vehicle from outside and is heated or cooled according to the function selected.

i Information

Using the system primarily in Fresh mode and Recirculation mode only when needed is recommended for best results.

Prolonged operation of the heater in Recirculation mode and without the A/C ON can cause fogging of the windshield.

In addition, prolonged use of the A/C ON in Recirculation mode may result in excessively dry, dehumidified air in the cabin.

⚠ WARNING

- Continued use of the climate control system operation in Recirculation mode for a prolonged period of time may cause drowsiness to the occupants in the cabin. This may lead to loss of vehicle control which may lead to an accident.
- Continued use of the climate control system operation in Recirculation mode with the A/C OFF may allow humidity to increase inside the cabin. This may cause condensation to accumulate on the windshield and obscure visibility.
- Do not sleep in your vehicle or remain parked in your vehicle with the windows up and either the heater or the air conditioning ON for prolonged periods of time. Doing so may increase the levels of carbon dioxide in the cabin which may lead to serious injury or death.

Fan speed control



The fan speed can be set to the desired speed by turning the fan speed control knob.

More air is delivered with higher fan speeds.

Pressing the OFF button turns off the fan.

NOTICE

Operating the fan speed when the START/STOP button is in the ON position could cause the battery to discharge. Operate the fan speed when the vehicle is in the ready (🚗) mode.

Driver only



If you press the DRIVER ONLY button ( DRIVER ONLY) and the indicator light illuminates, cold air mostly blows in the direction of the driver's seat. However, some of the cold air may come out of other seating position ducts to keep indoor air pleasant.

If you use the button with no passenger in the front passenger seat, energy consumption will be reduced.

DRIVER ONLY button will be turned off under the following conditions:

- 1) Defrost on
- 2) DRIVER ONLY button re-push

Air conditioning



Push the A/C button to turn the air conditioning system on (indicator light will illuminate).

Push the button again to turn the air conditioning system off.

HEAT button



Push the HEAT button to turn the heater on (indicator light will illuminate).

Push the button again to turn the heater off.

The air conditioner and heater uses energy from the battery. If you use the heater or air conditioner for too long, distance to empty can be reduced due to too much power consumption.

Turn off the heater and air conditioner if you do not need them.

Climate control information screen selection button



Push the climate control information screen selection button to display climate control information on the audio or AVN screen.

OFF mode

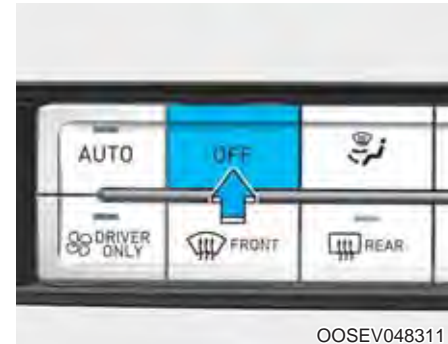

Push the OFF button to turn the climate control system off. However, you can still operate the mode and air intake buttons as long as the START/STOP button is in the ON position.

System operation

Ventilation

1. Select the Face Level  mode.
2. Set the air intake control to fresh mode.
3. Set the temperature control to the desired position.
4. Set the fan speed control to the desired speed.

Heating

1. Select the Floor Level  mode.
2. Set the air intake control to fresh mode.
3. Set the temperature control to the desired position.
4. Set the fan speed control to the desired speed.
5. If desired, turn the air conditioning ON with the temperature control knob set to heat in order to dehumidify the air before it enters into the cabin.

If the windshield fogs up, select the Floor & Defrost  mode or press the Front Defrost  mode.

Operation Tips

- To keep dust or unpleasant fumes from entering the vehicle through the ventilation system, temporarily set the air intake control to the recirculation mode. Be sure to return the control to fresh mode position when the irritation has passed to keep fresh air in the vehicle. This will help keep the driver alert and comfortable.
- To prevent interior fog on the windshield, set the air intake control to fresh mode and fan speed to the desired position, turn on the air conditioning system, and adjust the temperature control to desired temperature.

Air conditioning

HYUNDAI Air Conditioning Systems are filled with R-134a or R1234yf refrigerant.

1. Start the vehicle.
2. Push the air conditioning button.
3. Select the Face Level  mode.
4. Set the air intake control to Recirculation mode temporarily to allow the cabin to cool quickly. When the desired temperature in the cabin is reached, change the air intake control back to Fresh mode.
5. Adjust the fan speed control and temperature control to maintain maximum comfort.

NOTICE

- The refrigerant system should only be serviced by trained and certified technicians to insure proper and safe operation.
- The refrigerant system should be serviced in a well-ventilated place.
- The air conditioning evaporator (cooling coil) shall never be repaired or replaced with one removed from a used or salvaged vehicle and new replacement MAC evaporators shall be certified (and labeled) as meeting SAE Standard J2842.

i Information

When opening the windows in humid weather air conditioning may create water droplets inside the vehicle. Since excessive water droplets may cause damage to electrical equipment, air conditioning should only be used with the windows closed.

Air conditioning system operation tips

- If the vehicle has been parked in direct sunlight during hot weather, open the windows for a short time to let the hot air inside the vehicle escape.
- After sufficient cooling has been achieved, switch back from recirculation mode to fresh mode.
- To help reduce moisture inside of the windows on rainy or humid days, decrease the humidity inside the vehicle by operating the air conditioning system with the windows and sunroof closed.
- Use the air conditioning system every month for a few minutes to ensure maximum system performance.
- If you operate the air conditioner excessively, the difference between the temperature of the outside air and that of the windshield could cause the outer surface of the windshield to fog up, causing loss of visibility. In this case, set the mode selection button to the  position and set the fan speed control knob to the lowest speed setting.

System maintenance

Climate control air filter

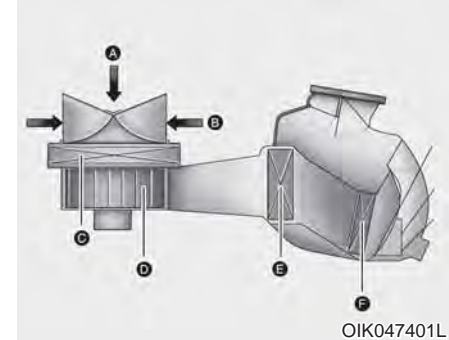

[A] : Outside air, [B] : Recirculated air
[C] : Climate control air filter, [D] : Blower
[E] : Evaporator core, [F] : Heater core

This filter is installed behind the glove box. It filters the dust or other pollutants that enter the vehicle through the heating and air conditioning system.

We recommend that the climate control air filter be replaced by an authorized HYUNDAI dealer according to the maintenance schedule. If the vehicle is being driven in severe conditions such as dusty or rough roads, more frequent climate control filter inspections and changes are required.

If the air flow rate suddenly decreases, we recommend the system be checked at an authorized HYUNDAI dealer.

Information

- Replace the filter according to the Maintenance Schedule.

If the car is being driven in severe conditions such as dusty, rough roads, more frequent climate control air filter inspections and changes are required.

- When the air flow rate suddenly decreases, we recommend that the system be checked by an authorized HYUNDAI dealer.

Checking the amount of air conditioner refrigerant and compressor lubricant

When the amount of refrigerant is low, the performance of the air conditioning is reduced. Overfilling also has a bad influence on the air conditioning system.

Therefore, if abnormal operation is found, we recommend that the system be inspected by an authorized HYUNDAI dealer.

WARNING

Vehicles equipped with R-134a



Because the refrigerant is at very high pressure, the air conditioning system should only be serviced by trained and certified technicians. It is important that the correct type and amount of oil and refrigerant is used.

Otherwise, it may cause damage to the vehicle and personal injury.

WARNING

Vehicles equipped with R-1234yf



Because the refrigerant is mildly inflammable at very high pressure, the air conditioning system should only be serviced by trained and certified technicians.

It is important that the correct type and amount of oil and refrigerant is used.



Otherwise, it may cause damage to the vehicle and personal injury.

We recommend the air conditioning system be serviced by an authorized HYUNDAI dealer.

WINDSHIELD DEFROSTING AND DEFOGGING

⚠ WARNING

Windshield heating

Do not use the  or  position during cooling operation in extremely humid weather. The difference between the temperature of the outside air and that of the windshield could cause the outer surface of the windshield to fog up, causing loss of visibility. In this case, set the mode selection knob or button to the  position and fan speed control knob or button to lower speed.

- For maximum defrost performance, set the temperature control knob to the highest temperature setting (rotated all the way to the right) and the fan speed control to the highest setting.
- If warm air to the floor is desired while defrosting or defogging, set the mode to the floor-defrost position.
- Before driving, clear all snow and ice from the windshield, rear window, outside rear view mirrors, and all side windows.
- Clear all snow and ice from the hood and air inlet in the cowl grill to improve heater and defroster efficiency and to reduce the probability of fogging up inside of the windshield.

To defog inside windshield



1. Select desired fan speed.
2. Select desired temperature.
3. Press the defroster button () .
4. Fresh mode will be selected automatically.

Check to make sure the air intake control is in Fresh mode. If the air intake control indicator light is illuminated, press the button once to enable Fresh mode (indicator light OFF).

If the  position is selected, the fan speed is automatically increased.

To defrost outside windshield



1. Set fan speed to the (extreme right) highest position.
2. Set temperature to the extreme hot (HI) position.
3. Press the defroster button (🌬️).
4. Fresh mode will be selected automatically.

Check to make sure the air intake control is in Fresh mode. If the air intake control indicator light is illuminated, press the button once to enable Fresh mode (indicator light OFF).

If the 🌬️ position is selected, the fan speed is automatically increased.

Defogging logic

To reduce the probability of fogging up the inside of the windshield, the air intake or air conditioning are controlled automatically according to certain conditions such as 🌬️ or 🌬️ position. To cancel or return the defogging logic, do the following.

1. Turn the START/STOP button to the ON position.
2. Press the defroster button (🌬️).
3. While pressing the air conditioning button (A/C), press the air intake control button at least 5 times within 3 seconds.

The air intake control button indicator will blink 3 times. It indicates that the defogging logic is canceled.

If the battery has been discharged or disconnected, it resets to the defog logic status.

Defroster

NOTICE

To prevent damage to the conductors bonded to the inside surface of the rear window, never use sharp instruments or window cleaners containing abrasives to clean the window.

i Information

If you want to defrost and defog the front windshield, refer to “Windshield Defrosting and Defogging” in this chapter.

Rear window defroster



The defroster heats the window to remove frost, fog and thin ice from the interior and exterior of the rear window, while the vehicle is in the ready (🚗) mode.

- To activate the rear window defroster, press the rear window defroster button located in the center facia switch panel. The indicator on the rear window defroster button illuminates when the defroster is ON.
- To turn off the defroster, press the rear window defroster button again.

i Information

- If there is heavy accumulation of snow on the rear window, brush it off before operating the rear defroster.
- The rear window defroster automatically turns off after approximately 20 minutes or when the START/STOP button is in the OFF position.

Auto defogging system



Auto defogging reduces the possibility of fogging up the inside of the windshield by automatically sensing the moisture of inside the windshield.

The auto defogging system operates when the heater or air conditioning is on.

i Information

The auto defogging system may not operate normally, when the outside temperature is below -10°C .



When the Auto Defogging System operates, the indicator will illuminate.

If a high amount of humidity is detected in the vehicle, the Auto Defogging System will be enabled.

The following steps will be performed automatically:

- Step 1) The A/C button will turn ON.
- Step 2) The air intake control will change to Fresh mode.
- Step 3) The mode will be changed to defrost to direct airflow to the windshield.
- Step 4) The fan speed will be set to MAX.

If the air conditioning is off or recirculated air position is manually selected while Auto Defogging System is ON, the Auto Defogging System Indicator will blink 3 times to signal that the manual operation has been canceled.

To cancel the auto defogging system

1. Press the START/STOP button to the ON position.
2. Press the front defroster button over 3 seconds.
3. The front defroster button indicator will blink 3 times and then ADS OFF will illuminate on the climate control information screen when the auto defogging system is canceled.

To reactivate the auto defogging system

1. Press the START/STOP button to the ON position.
2. Press the front defroster button over 3 seconds.
3. The front defroster button indicator will blink 6 times and then ADS OFF will go out on the climate control information screen when the auto defogging system is reactivated.

i Information

- When the air conditioning is turned on by Auto defogging system, if you try to turn off the air conditioning, the indicator will blink 3 times and the air conditioning will not be turned off.
- To maintain the effectiveness and efficiency of the Auto Defogging System, do not select Recirculation mode while the system is operating.
- When the Auto Defogging System is operating, the fan speed adjustment knob, the temperature adjustment knob, and the air intake control button are all disabled.

NOTICE

Do not remove the sensor cover located on the upper end of the windshield glass.

Damage to system parts could occur and may not be covered by your vehicle warranty.

CLIMATE CONTROL ADDITIONAL FEATURES

Automatic ventilation

The system automatically selects the fresh mode when the climate control system operates over a certain period of time (approximately 30 minutes) in low temperature with the recirculation mode selected.

To cancel or reactivate the Automatic Ventilation

When the air conditioning system is on, select Face Level  mode and press the air recirculation mode button for 3 seconds.

When the automatic ventilation is canceled, the indicator blinks 3 times. When the automatic ventilation is activated, the indicator blinks 6 times.

STORAGE COMPARTMENT

⚠ WARNING

Never store cigarette lighters, propane cylinders, or other flammable/explosive materials in the vehicle. These items may catch fire and/or explode if the vehicle is exposed to hot temperatures for extended periods.

⚠ WARNING

ALWAYS keep the storage compartment covers closed securely while driving. Items inside your vehicle are moving as fast as the vehicle. If you have to stop or turn quickly, or if there is a crash, the items may fly out of the compartment and may cause an injury if they strike the driver or a passenger.

NOTICE

To avoid possible theft, do not leave valuables in the storage compartments.

Center console storage



To open :

Grab and hold the latch (1) on the arm rest then lift the lid.

Glove box



To open:

Pull the lever (1).

⚠ WARNING

ALWAYS close the glove box door after use.

An open glove box door can cause serious injury to the passenger in an accident, even if the passenger is wearing a seat belt.

Sunglass holder (if equipped)



To open:

Push and release the cover and the holder will slowly open. Place your sunglasses in the compartment door with the lenses facing out.

To close:

Push back into position.

Make sure the sunglasses holder is closed while driving.

WARNING

- Do not keep objects except sunglasses inside the sunglasses holder. Such objects can be thrown from the holder in the event of a sudden stop or an accident, possibly injuring the passengers in the vehicle.
- Do not open the sunglasses holder while the vehicle is moving. The rear view mirror of the vehicle can be blocked by an open sunglasses holder.
- Do not put the glasses forcibly into a sunglasses holder. It may cause personal injury if you try to open it forcibly when the glasses are jammed in holder.

INTERIOR FEATURES

Cup holder

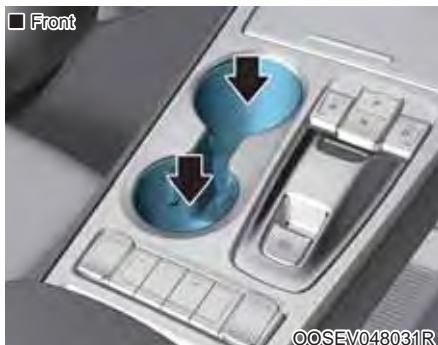

Cups or small beverages cups may be placed in the cup holders.

Rear

Pull the armrest down to use the cup holders.

⚠ WARNING

- Avoid abrupt starting and braking when the cup holder is in use to prevent spilling your drink. If hot liquid spills, you could be burned. Such a burn to the driver could cause loss of vehicle control resulting in an accident.
- Do not place uncovered or unsecured cups, bottles, cans, etc., in the cup holder containing hot liquid while the vehicle is in motion. Injuries may result in the event of sudden stop or collision.
- Only use soft cups in the cup holders. Hard objects can injure you in an accident.

⚠ WARNING

Keep cans or bottles out of direct sun light and do not put them in a hot vehicle. It may explode.

NOTICE

- Keep your drinks sealed while driving to prevent spilling your drink. If liquid spills, it may get into the vehicle's electrical/electronic system and damage electrical/electronic parts.
- When cleaning spilled liquids do not use hot air to blow out or dry the cup holder. This may damage the interior.

Sunvisor

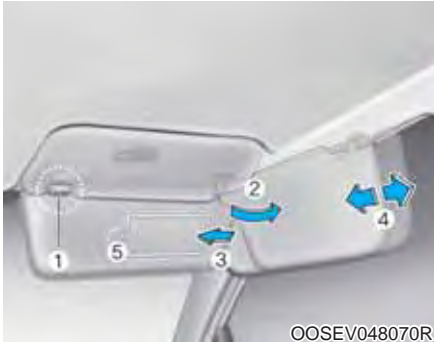

To use a sunvisor, pull it downward.

To use a sunvisor for a side window, pull it downward, unsnap it from the bracket (1) and swing it to the side (2).

To use the vanity mirror, pull down the sunvisor and slide the mirror cover (3).

Adjust the sunvisor forward or backward (4) as needed (if equipped).

Use the ticket holder (5) to hold tickets.

Close the vanity mirror cover securely and return the sunvisor to its original position after use.

WARNING

For your safety, do not block your view when using the sunvisor.

NOTICE

Do not put several tickets in the ticket holder at one time. This could cause damage to the ticket holder.

Power outlet (if equipped)



The power outlet is designed to provide power for mobile telephones or other devices designed to operate with vehicle electrical systems. The devices should draw less than 180 W(Watt) with the vehicle in the ready () mode.

WARNING

Avoid electrical shocks. Do not place your fingers or foreign objects (pin, etc.) into a power outlet or touch the power outlet with a wet hand.

NOTICE

To prevent damage to the Power Outlets :

- Use the power outlet only when the vehicle is in the ready (🚗) mode and remove the accessory plug after use. Using the accessory plug for prolonged periods of time with the vehicle off could cause the battery to discharge.
- Only use 12V electric accessories which are less than 180 W(Watt) in electric capacity.
- Adjust the air-conditioner or heater to the lowest operating level when using the power outlet.
- Close the cover when not in use.
- Some electronic devices can cause electronic interference when plugged into a vehicle's power outlet. These devices may cause excessive audio static and malfunctions in other electronic systems or devices used in your vehicle.

- Push the plug in as far as it will go. If good contact is not made, the plug may overheat and the fuse may open.
- Plug in battery equipped electrical/electronic devices with reverse current protection. The current from the battery may flow into the vehicle's electrical/electronic system and cause system malfunction.

USB charger (if equipped)



The USB charger is designed to recharge batteries of small size electrical devices using a USB cable. The electrical devices can be recharged when the START/STOP button is in the ACC, ON or START position.

The battery charging state may be monitored on the electrical device.

Disconnect the USB cable from the USB port after use.

- A smart phone or a tablet PC may get warmer during the re-charging process. It does not indicate any malfunction with the charging system.
- A smart phone or a tablet PC, which adopts a different re-charging method, may not be properly re-charged. In this case, use an exclusive charger of your device.
- The charging terminal is only to recharge a device. Do not use the charging terminal either to turn ON an audio or to play media on the AVN.

Wireless cellular phone charging system (if equipped)



[A]: Indicator light, [B]: Charging pad

There is a wireless cellular phone charger inside the front console.

To use the wireless cellular phone charging system, open the front console cover by pressing the lower part of the cover (1).

After use, to close the cover, slightly pull down the cover.

The system is available when all doors are closed, and when the START/STOP button is in the ACC, ON or START position.

To charge a cellular phone

The wireless cellular phone charging system charges only the Qi-enabled cellular phones (Qi). Read the label on the cellular phone accessory cover or visit your cellular phone manufacturer's website to check whether your cellular phone supports the Qi technology.

The wireless charging process starts when you put a Qi-enabled cellular phone on the wireless charging unit.

1. Remove other items, including the smart key, from the wireless charging unit. If not, the wireless charging process may be interrupted. Place the cellular phone on the center of charging pad.
2. The indicator light is orange when the cellular phone is charging. The indicator light turns green when phone charging is complete.
3. You can turn ON or OFF the wireless charging function in the User Settings mode on the instrument cluster. For further information, refer to the "LCD Display Modes" in this chapter.

If your cellular phone is not charging:

- Slightly change the position of the cellular phone on the charging pad.
- Make sure the indicator light is orange.

The indicator light will blink orange for 10 seconds if there is a malfunction in the wireless charging system.

In this case, temporarily stop the charging process, and re-attempt to wirelessly charge your cellular phone again.

The system warns you with a message on the LCD display if the cellular phone is still on the wireless charging unit after the vehicle is turned OFF and the front door is opened.

Information

For some manufacturers' cellular phones, the system may not warn you even though the cellular phone is left on the wireless charging unit. This is due to the particular characteristic of the cellular phone and not a malfunction of the wireless charging.

NOTICE

- The wireless cellular phone charging system may not support certain cellular phones, which are not verified for the Qi specification (Qi).
- When placing your cellular phone on the charging mat, position the phone in the middle of the mat for optimal charging performance. If your cell phone is off to the side, the charging rate may be less and in some cases the cell phone may experience higher heat conduction.
- In some cases, the wireless charging may stop temporarily when the Smart Key is used, either when starting the vehicle or locking/unlocking the doors, etc.
- When charging certain cellular phones, the charging indicator may not change to green when the cell phone is fully charged.
- The wireless charging process may temporarily stop, when temperature abnormally increases inside the wireless cellular phone charging system. The wireless charging process restarts, when temperature falls to a certain level.
- The wireless charging process may temporarily stop when there is any metallic item, such as a coin, between the wireless cellular phone charging system and a cellular phone.
- For certain cellular phones with their own protection, the wireless charging speed may decrease and the wireless charging may stop.
- If the cellular phone has a thick cover, the wireless charging may not be possible.

- If the cell phone is not completely contacting the charging pad, wireless charging may not operate properly.
- Some magnetic items like credit cards, phone cards or rail tickets may be damaged if left with the cellular phone during the charging process.
- If the cellular phone without the wireless charging function or the metallic items are placed on the charging pad, it may cause slight noise. This noise does not affect the cellular phone and the vehicle, because this noise is an operating sound during determining the item on the charging pad.
- If the START/STOP button is OFF, the charging also stops.

Clock

WARNING

Do not adjust the clock while driving. You may lose your steering control and cause severe personal injury or accidents.

Vehicles with Audio system

Select the Settings menu on the Audio screen → Select [Date/Time].

- Set time: Set the time displayed on the audio screen.
- Time format: Choose between 12-hour and 24-hour time formats.

Vehicles with Navigation system

Select the Settings menu on the AVN screen → Select [Date/Time].

- GPS time: Displays time according to the received GNSS time.
- 24-hour: Switches to 12 hour or 24 hour.

For more details, please refer to the separate manual that was supplied with your vehicle.

Clothes hanger (if equipped)



These hangers are not designed to hold large or heavy items.

⚠ WARNING

A photograph showing a clothes hanger hanging from the anchor in the storage pocket. A red prohibition sign (a circle with a diagonal line) is overlaid on the top right of the image, indicating that hanging other objects is not allowed. The image is labeled with the code OOS047066 in the bottom right corner.

Do not hang other objects such as hangers or hard objects except clothes. Also, do not put heavy, sharp or breakable objects in the clothes pockets. In an accident or when the curtain air bag is inflated, it may cause vehicle damage or personal injury.

Floor mat anchor(s) (if equipped)



ALWAYS use the Floor Mat Anchors to attach the front floor mats to the vehicle. The anchors on the front floor carpet keep the floor mats from sliding forward.

⚠ WARNING

The following must be observed when installing ANY floor mat to the vehicle.

- Ensure that the floor mats are securely attached to the vehicle's floor mat anchor(s) before driving the vehicle.
- Do not use ANY floor mat that cannot be firmly attached to the vehicle's floor mat anchors.
- Do not stack floor mats on top of one another (for example, all-weather rubber mat on top of a carpeted floor mat). Only a single floor mat should be installed in each position.

IMPORTANT - Your vehicle was manufactured with driver's side floor mat anchors that are designed to securely hold the floor mat in place. To avoid any interference with pedal operation, HYUNDAI recommends that the HYUNDAI floor mat designed for use in your vehicle be installed.

Luggage net (holder) (if equipped)



OOSEV048036

To keep items from shifting in the cargo area, you can use the four holders located in the cargo area to attach the luggage net.

If necessary, we recommend that you contact your authorized HYUNDAI dealer to obtain a luggage net.

⚠ CAUTION

To prevent damage to the goods or the vehicle, care should be taken when carrying fragile or bulky objects in the luggage compartment.

⚠ WARNING

To avoid eye injury, **DO NOT** overstretch the luggage net. **ALWAYS** keep your face and body out of the luggage net's recoil path. **DO NOT** use the luggage net when the strap has visible signs of wear or damage.

Cargo area cover (if equipped)



Use the cover to hide items stored in the cargo area.

The cargo area cover will lift when the tailgate is opened.

Disconnect the strap (1) from the holder if you want to return the cover to the original position. To remove the cargo area cover completely, lift the cover to a 50-degree angle and pull it out (2).

NOTICE

Since the cargo area cover may be damaged or deformed, do not put luggage on it when it is being used.

⚠ WARNING

- Do not place objects on the cargo area cover while driving. Such objects may be thrown about inside the vehicle and possibly injure vehicle occupants during an accident or when braking.
- Never allow anyone to ride in the luggage compartment. It is designed for luggage only.
- Maintain balance of the vehicle and locate the weight as far forward as possible.

EXTERIOR FEATURES

Roof rack (if equipped)



If the vehicle has a roof rack, you can load cargo on top of your vehicle.

NOTICE

If the vehicle is equipped with a sunroof, be sure not to position cargo onto the roof rack in such a way that it could interfere with sunroof operation.

NOTICE

- When carrying cargo on the roof rack, take the necessary precautions to make sure the cargo does not damage the roof of the vehicle.
- When carrying large objects on the roof rack, make sure they do not exceed the overall roof length or width.

WARNING

- The following specification is the maximum weight that can be loaded onto the roof rack. Distribute the load as evenly as possible onto the roof rack and secure the load firmly.

ROOF RACK	80 kg (176 lbs.) EVENLY DISTRIBUTED
-----------	----------------------------------------

Loading cargo or luggage in excess of the specified weight limit on the roof rack may damage your vehicle.

- The vehicle center of gravity will be higher when items are loaded onto the roof rack. Avoid sudden starts, braking, sharp turns, abrupt maneuvers or high speeds that may result in loss of vehicle control or rollover resulting in an accident.
- Always drive slowly and turn corners carefully when carrying items on the roof rack. Severe wind updrafts, caused by passing vehicles or natural causes, can cause sudden upward pressure on items loaded on the roof rack. This is especially true when carrying large, flat items such as wood panels or mattresses. This could cause the items to fall off the roof rack and cause damage to your vehicle or others around you.
- To prevent damage or loss of cargo while driving, check frequently before or while driving to make sure the items on the roof rack are securely fastened.

Infotainment System

Infotainment system.....	5-2
AUX, USB and iPod® port	5-2
Antenna.....	5-2
Steering wheel audio controls.....	5-3
Bluetooth® Wireless Technology hands-free	5-5
Audio system.....	5-5

INFOTAINMENT SYSTEM

i Information

- If you install an aftermarket HID headlamp, your vehicle's audio and electronic devices may malfunction.
- Prevent chemicals such as perfume, cosmetic oil, sun cream, hand cleaner, and air freshener from contacting the interior parts because they may cause damage or discoloration.

AUX, USB and iPod® port



You can use an AUX port to connect audio devices and an USB port to plug in an USB and an iPod® port.

To use the AUX, USB and iPod®, open the front console cover by slightly pressing the lower part of the cover (1).

After use, to close the cover, slightly pull down the cover.

i Information

When using a portable audio device connected to the power outlet, noise may occur during playback. If this happens, use the power source of the portable audio device.

* iPod® is a trademark of Apple Inc.

Antenna

Roof antenna



The roof antenna receives transmitted data. (For example : AM/FM)

Rotate the roof antenna in a counterclockwise direction to remove it. Rotate it in a clockwise direction to reinstall it.

NOTICE

- Before entering a place with low height clearance or a car wash, remove the antenna by rotating it counterclockwise. If not, the antenna may be damaged.
- When reinstalling your antenna, it is important that it is fully tightened and adjusted to the upright position to ensure proper reception.

Steering wheel audio controls (if equipped)



The steering wheel audio control switches are installed for your convenience.

NOTICE

Do not operate audio remote control buttons simultaneously.

VOLUME (VOL +/-) (1)

- Move the VOLUME toggle switch up to increase volume.
- Move the VOLUME toggle switch down to decrease volume.

SEEK/PRESET (^/∨) (2)

If the SEEK/PRESET toggle switch is moved up or down and held for 0.8 seconds or more, it will function in the following modes.

RADIO mode

It will function as the AUTO SEEK select switch. It will SEEK until you release the switch.

MEDIA mode

It will function as the FF/REW switch.

If the SEEK/PRESET toggle switch is moved up or down, it will function in the following modes.

RADIO mode

It will function as the PRESET STATION UP/DOWN switch.

MEDIA mode

It will function as the TRACK UP/DOWN switch.

MODE (⊙) (3)

Press the MODE button to select Various Available Media sources like Radio, USB, AUX and BT audio.

MUTE (🔇) (4)

- Press the button to mute the sound.
- Press the button again to activate the sound.

Information

Detailed information is described in a separately supplied manual.

Bluetooth® Wireless Technology hands-free



OOSEV048043



©OSEEV048050R

You can use the phone wirelessly by using the *Bluetooth®* Wireless Technology.

- (1) Call / Answer button
- (2) Call end button
- (3) Microphone

- Audio : For detailed information, refer to “AUDIO” in this chapter.
- Detailed information for the *Bluetooth®* Wireless Technology hands-free is described in the manual supplied separately.

Audio system (if equipped)

Detailed information for the Audio system is described in a separately supplied manual.

Driving Your Vehicle

Before driving	6-2	Drive mode integrated control system	6-39
Before entering the vehicle	6-2	Drive mode	6-39
Before starting	6-2	Initial setting for each Drive Mode.....	6-39
Start/stop button	6-3	Cruise control	6-40
Start/stop button positions.....	6-5	Cruise Control operation	6-40
Starting the vehicle	6-7	Winter driving	6-45
Turning off the vehicle	6-9	Snow or icy conditions	6-45
Reduction gear	6-10	Winter precautions.....	6-47
Reduction gear operation.....	6-10	Vehicle weight	6-49
Parking	6-13	Overloading	6-49
LCD display messages.....	6-13	Trailer towing	6-50
Good driving practices.....	6-17		
Regenerative braking system	6-18		
Regenerative braking (Paddle shifter).....	6-18		
One pedal driving.....	6-19		
Braking system	6-20		
Power brakes	6-20		
Disc brakes wear indicator	6-21		
Electronic parking brake (EPB)	6-21		
Auto hold	6-27		
Anti-lock Brake System (ABS)	6-31		
Electronic Stability Control (ESC).....	6-33		
Vehicle Stability Management (VSM).....	6-36		
Hill-Start Assist Control (HAC)	6-37		
Good braking practices	6-38		

BEFORE DRIVING

Before entering the vehicle

- Be sure all windows, outside mirror(s), and outside lights are clean and unobstructed.
- Remove frost, snow, or ice.
- Visually check the tires for uneven wear and damage.
- Check under the vehicle for any sign of leaks.
- Be sure there are no obstacles behind you if you intend to back up.

Before starting

- Make sure the hood, the tailgate, and the doors are securely closed and locked.
- Adjust the position of the seat and steering wheel.
- Adjust the inside and outside rear-view mirrors.
- Verify all the lights work.
- Fasten your seat belt. Check that all passengers have fastened their seat belts.
- Check the gauges and indicators in the instrument panel and the messages on the instrument display when the START/STOP button is in the ON position.
- Check that any items you are carrying are stored properly or fastened down securely.

WARNING

To reduce the risk of **SERIOUS INJURY** or **DEATH**, take the following precautions:

- **ALWAYS wear your seat belt. All passengers must be properly belted whenever the vehicle is moving. For more information, refer to "Seat Belts" in chapter 2.**
- **Always drive defensively. Assume other drivers or pedestrians may be careless and make mistakes.**
- **Stay focused on the task of driving. Driver distraction can cause accidents.**
- **Leave plenty of space between you and the vehicle in front of you.**

⚠ WARNING

NEVER drink or take drugs and drive.

Drinking or taking drugs and driving is dangerous and may result in an accident and **SERIOUS INJURY** or **DEATH**.

Drunk driving is the number one contributor to the highway death toll each year. Even a small amount of alcohol will affect your reflexes, perceptions and judgment. Just one drink can reduce your ability to respond to changing conditions and emergencies and your reaction time gets worse with each additional drink.

Driving while under the influence of drugs is as dangerous as or more dangerous than driving under the influence of alcohol.

You are much more likely to have a serious accident if you drink or take drugs and drive. If you are drinking or taking drugs, don't drive. Do not ride with a driver who has been drinking or taking drugs. Choose a designated driver or call a taxi.

START/STOP BUTTON

⚠ WARNING

To reduce the risk of **SERIOUS INJURY** or **DEATH**, take the following precautions:

- **NEVER** allow children or any person who is unfamiliar with the vehicle to touch the **START/STOP** button or related parts. Unexpected and sudden vehicle movement can occur.
- **NEVER** reach through the steering wheel for the **START/STOP** button or any other control, while the vehicle is in motion. The presence of your hand or arm in this area may cause a loss of vehicle control resulting in an accident.



Whenever the front door is opened, the START/STOP button will illuminate and will go off 30 seconds after the door is closed.

⚠ WARNING

To turn the vehicle off in an emergency:



Press and hold the START/STOP button for more than two seconds OR Rapidly press and release the START/STOP button three times (within three seconds).



If the vehicle is still moving, you can restart the vehicle without depressing the brake pedal by pressing the START/STOP button with the gear in the N (Neutral) position.

⚠ WARNING

- **NEVER** press the START/STOP button while the vehicle is in motion except in an emergency. This will result in the vehicle turning off and loss of power assist for the steering and brake systems. This may lead to loss of directional control and braking function, which could cause an accident.
- Before leaving the driver's seat, always make sure the gear is in the P (Park) position, set the parking brake, press the START/STOP button to the OFF position, and take the Smart Key with you. Unexpected vehicle movement may occur if these precautions are not followed.

START/STOP button positions

Button Position	Action	Notice
<p data-bbox="233 288 289 311">OFF</p> 	<p data-bbox="407 291 894 346">To turn off the vehicle, press the START/STOP button with the gear in P (Park).</p> <p data-bbox="407 358 922 550">Also, the vehicle will turn off when the START/STOP button is pressed with the gear in D (Drive) or R (Reverse) because the gear automatically shifts to the P (Park) position. But, when it is pressed in N (Neutral), the START/STOP button will go to the ACC position.</p> <p data-bbox="407 562 911 617">The steering wheel locks to protect the vehicle from theft.</p>	<p data-bbox="953 291 1458 373">If the steering wheel is not locked properly when you open the driver's door, the warning chime will sound.</p>
<p data-bbox="233 665 289 689">ACC</p> 	<p data-bbox="407 669 883 751">Press the START/STOP button when the button is in the OFF position without depressing the brake pedal.</p> <p data-bbox="407 763 919 818">Some of the electrical accessories are usable.</p> <p data-bbox="407 830 740 853">The steering wheel unlocks.</p>	<p data-bbox="953 669 1482 806">If the steering wheel doesn't unlock properly, the START/STOP button will not work. Press the START/STOP button while turning the steering wheel right and left to release tension.</p>



Button Position	Action	Notice
<p data-bbox="240 239 282 263">ON</p> 	<p data-bbox="404 244 915 326">Press the START/STOP button while it is in the ACC position without depressing the brake pedal.</p> <p data-bbox="404 338 902 391">The warning lights can be checked before the vehicle is started.</p>	<p data-bbox="948 244 1471 356">Do not leave the START/STOP button in the ON position when the vehicle is not in the ready (🚗) mode to prevent the battery from discharging.</p>
<p data-bbox="215 548 306 571">START</p> 	<p data-bbox="404 550 899 632">To start the vehicle, depress the brake pedal and press the START/STOP button with the gear in the P (Park) position.</p>	<p data-bbox="948 550 1468 662">If you press the START/STOP button without depressing the brake pedal, the vehicle does not start and the START/STOP button changes as follows:</p> <p data-bbox="948 671 1382 695">OFF ACC ON OFF or ACC</p>

Starting the vehicle

WARNING

- Always wear appropriate shoes when operating your vehicle. Unsuitable shoes, such as high heels, ski boots, sandals, flip-flops, etc., may interfere with your ability to use the brake and accelerator pedals.
- Do not start the vehicle with the accelerator pedal depressed.
The vehicle can move and lead to an accident.

Information

- The vehicle will start by pressing the START/STOP button, only when the smart key is in the vehicle.
- Even if the smart key is in the vehicle, and when it is far away from the driver, the vehicle may not start.
- When the START/STOP button is in the ACC or ON position, any door is open, the system checks for the smart key. When the smart key is not in the vehicle, the "" indicator will blink and the warning "Key not in vehicle" will come on. When all doors are closed, the chime will also sound for about 5 seconds. Keep the smart key in the vehicle when in the ACC position or if the vehicle is in the ready () mode.

1. Always carry the smart key with you.
2. Make sure the parking brake is applied.
3. Make sure the gear is in P (Park).
4. Depress the brake pedal.
5. Press the START/STOP button. If the vehicle starts, the "" indicator will come on.

Information

- Always start the vehicle with your foot on the brake pedal. Do not depress the accelerator while starting the vehicle.
- If ambient temperature is low, the "" indicator may remain illuminated longer than the normal amount of time.

NOTICE

To prevent damage to the vehicle:

- If the "🚗" indicator turns off while you are in motion, do not attempt to shift to the P (Park) position.

If traffic and road conditions permit, you may shift to the N (Neutral) position while the vehicle is still moving and press the START/STOP button in an attempt to restart the vehicle.

- Do not push or tow your vehicle to start the vehicle.

NOTICE

To prevent damage to the vehicle:

Do not press the START/STOP button for more than 10 seconds except when the stop lamp fuse is blown.

When the stop lamp fuse is blown, you cannot normally start the vehicle. Replace the fuse with a new one. If you are not able to replace the fuse, you can start the vehicle by pressing and holding the START/STOP button for 10 seconds with the START/STOP button in the ACC position.

For your safety always depress the brake pedal before starting the vehicle.

Emergency starting



If the smart key battery is weak or the smart key does not work correctly, you can start the vehicle by pressing the START/STOP button with the smart key in the direction of the picture above.

Turing off the vehicle

1. Depress the brake pedal fully.
2. Shift to P (Park).
3. Apply the parking brake.
4. Press the START/STOP button to turn the vehicle off.
5. Make sure the " " indicator light on the instrument cluster is turned off.



CAUTION

If the " " indicator light on the instrument cluster is still on, the vehicle is not turned off and can move when the gear is in any position except P (Park).

REDUCTION GEAR

Reduction gear operation

WARNING

To reduce the risk of serious injury or death:

- **ALWAYS** check the surrounding areas near your vehicle for people, especially children, before shifting a vehicle into D (Drive) or R (Reverse).
- Before leaving the driver's seat, always make sure the gear is in the P (Park) position, then set the parking brake, and place the START/STOP button in the OFF position. Unexpected and sudden vehicle movement can occur if these precautions are not followed.



OOSEV058004R

Select gear positions by pressing the shift button.

For your safety, always depress the brake pedal while shifting to another gear.

Gear position



©OSEEV043105

The indicator in the instrument cluster displays the gear position when the START/STOP button is in the ON position.

P (Park)

Always come to a complete stop before shifting into P (Park).

To shift the gear from R (Reverse), N (Neutral) or D (Drive) to P (Park), press the [P] button.

If you turn off the vehicle in D (Drive) or R (Reverse), the gear automatically shifts to P (Park).

- With the vehicle on, the gear automatically shifts to P (Park) if you open the driver's door when the gear is in N (Neutral), R (Reverse) or D (Drive) and the following conditions are met:
 - The brake/accelerator pedal is not depressed
 - Seat belt is unfastened
 - The vehicle speed is below 0.6 km/h
- When the vehicle is over a certain speed, the gear does not shift to P (Park) when the P button is pressed.

WARNING

- **Shifting into P (Park) while the vehicle is in motion may cause you to lose control of the vehicle.**
- **After the vehicle has stopped, always make sure the gear is in P (Park), apply the parking brake, and turn the vehicle off.**
- **Do not use the P (Park) position in place of the parking brake.**

R (Reverse)

Use this position to drive the vehicle backward.

To shift to R (Reverse), press the [R] button while depressing the brake pedal.

N (Neutral)

The wheels and gear are not engaged.

To shift to N (Neutral), press the [N] button while depressing the brake pedal.

Always depress the brake pedal when you are shifting from N (Neutral) to another gear.

In N (Neutral), if the driver attempts to turn off the vehicle, the gear remains in N (Neutral) and the START/STOP button will be in the ACC position.

To turn off the vehicle from the ACC position, press the START/STOP button to the ON position, press the [P] button, and press the START/STOP button to the OFF position.

When the driver's door is opened within 3 minutes with the START/STOP button in the ACC position and the gear in N (Neutral), the vehicle is automatically turned OFF and shifted to the P (Park) position.

D (Drive)

This is the normal driving position.

To shift to D (Drive), press the [D] button while depressing the brake pedal.

Shift-lock system

For your safety, your vehicle has a shift-lock system which prevents shifting the gear from P (Park) or N (Neutral) into R (Reverse) or D (Drive) unless the brake pedal is depressed.

To shift from P (Park) or N (Neutral) into R (Reverse) or D (Drive), from R (Reverse) into D (Drive) or from D (Drive) into R (Reverse) :

1. Depress and hold the brake pedal.
2. Start the vehicle or place the START/STOP button in the ON position.
3. Press the R (Reverse) or D (Drive) button.

***i* Information**

For your safety, you cannot shift the gear while the charging cable is connected.

When the battery (12 V) is discharged

You cannot shift the gear when the battery is discharged.

Jump start your vehicle (refer to "Jump Starting" in chapter 6) or we recommend that you contact an authorized HYUNDAI dealer.

Parking

Always come to a complete stop and continue to depress the brake pedal. Shift to the P (Park) position, apply the parking brake, and place the START/STOP button in the OFF position. Take the Key with you when exiting the vehicle.

LCD display messages *Shifting conditions not met*



The message appears on the LCD display in the following conditions:

1. When driving speed is too fast to shift the gear.
Decrease the vehicle speed or slow down before shifting the gear.
2. When the gear is shifted while the vehicle is in utility mode.

Press brake pedal to change gear



The message appears on the LCD display, when the brake pedal is not depressed while shifting the gear. Depress the brake pedal and then shift the gear.

Shift to P after stopping



The message appears on the LCD display when the gear is shifted to P (Park) while the vehicle is moving. Stop the vehicle before shifting to P (Park).

PARK engaged

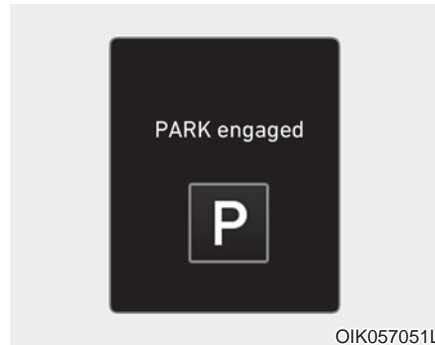

The message appears on the LCD display when the P (Park) position is engaged.

NEUTRAL engaged

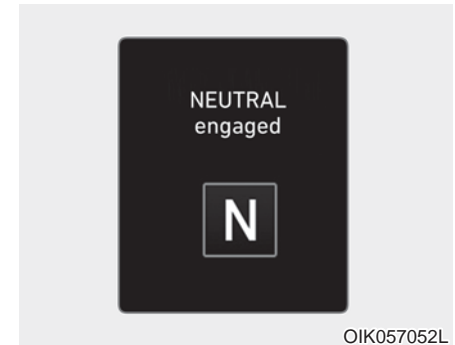

The message appears on the LCD display when the N (Neutral) position is engaged.

This gear is already selected

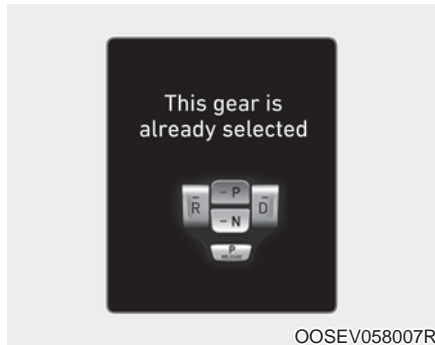

The message appears on the LCD display when the selected gear button is pressed again.

PARK button error! Engage parking brake when parking vehicle



The message is displayed when there is a problem with function engaging P (Park) position.

We recommend that you immediately have the vehicle inspected by an authorized HYUNDAI dealer.

D button error! Shifting back to D not possible if gear changed or vehicle Off



The message is displayed when there is a problem with the D button. If this message is displayed, do not shift the gear or turn the vehicle off while driving. If the driver shifts the gear to P/R/N position or turns off the engine, it is impossible to shift back to D (Drive).

Check P button



The message appears on the LCD display when there is problem with the P button.

We recommend that you immediately have the vehicle inspected by an authorized HYUNDAI dealer.

Check shift controls

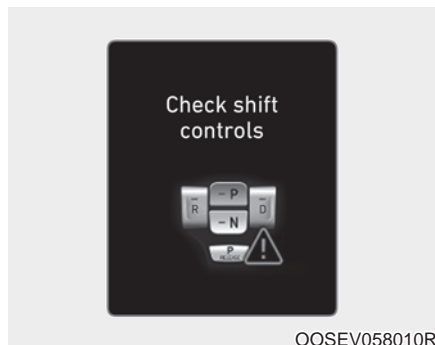

The message appears on the LCD display when there is problem with the shift buttons.

We recommend that you immediately have the vehicle inspected by an authorized HYUNDAI dealer

Shift button is stuck

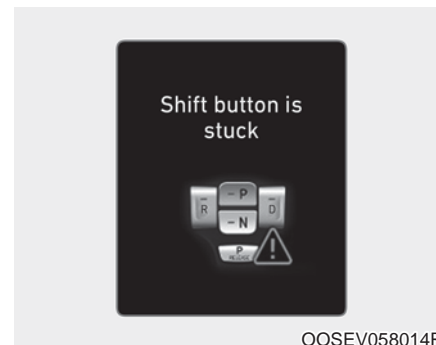

The message appears on the LCD display when the shift button is continuously pressed or there is problem with the button.

Make sure that there is no object over the shift button. If the problem persists, we recommend that you immediately have the vehicle inspected by an authorized HYUNDAI dealer

Good driving practices

- Never shift to P (Park) or N (Neutral) to any other position with the accelerator pedal depressed.
- Never shift to P (Park) when the vehicle is in motion.

Be sure the vehicle is completely stopped before you attempt to shift into R (Reverse) or D (Drive).

- Do not shift to N (Neutral) when driving. Doing so may result in an accident.
- Do not drive with your foot resting on the brake pedal. Even light, but consistent pedal pressure can result in the brakes overheating, brake wear and possibly even brake failure.
- Always apply the parking brake when leaving the vehicle. Do not depend on placing the gear in P (Park) to keep the vehicle from moving.

- Exercise extreme caution when driving on a slippery surface. Be especially careful when braking, accelerating or shifting gears. On a slippery surface, an abrupt change in vehicle speed can cause the drive wheels to lose traction and may cause loss of vehicle control resulting in an accident
- Optimum vehicle performance and economy is obtained by smoothly depressing and releasing the accelerator.

WARNING

To reduce the risk of SERIOUS INJURY or DEATH:

- **ALWAYS wear your seat belt. In a collision, an unbelted occupant is significantly more likely to be seriously injured or killed than a properly belted occupant.**
- **Avoid high speeds when cornering or turning.**

- **Do not make quick steering wheel movements, such as sharp lane changes or fast, sharp turns.**
- **The risk of rollover is greatly increased if you lose control of your vehicle at highway speeds.**
- **Loss of control often occurs if two or more wheels drop off the roadway and the driver over steers to reenter the roadway.**
- **In the event your vehicle leaves the roadway, do not steer sharply. Instead, slow down before pulling back into the travel lanes.**
- **HYUNDAI recommends you follow all posted speed limits.**

REGENERATIVE BRAKING SYSTEM

Regenerative braking (Paddle shifter)



The paddle shifter is used to adjust the regenerative braking level from 0 to 3 during decelerating or braking.

- Left side (☞): Increases regenerative braking and deceleration.
- Right side (☜): Decreases regenerative braking and deceleration.
- Pull and hold the left side paddle shifter for more than 0.5 seconds and One Pedal Driving function is operated, increasing the regenerative braking. In this case, stopping the vehicle is possible by keep on pulling the paddle shifter.

Refer to the following pages on "One Pedal Driving".

- With the Smart Recuperation System activated, pull and hold the right side paddle shifter for over 1 second to turn on and off the automatic change of the regenerative braking. However, nothing will happen if the Smart Recuperation System is not activated from the User Settings mode. To activate or deactivate the function go to 'User settings → Convenience → Smart recuperation'. Refer to the following pages on "Smart Recuperation System".

i Information

The paddle shifter does not operate when:

- The [☞] and [☜] paddle shifters are pulled at the same time.
- The vehicle is decelerating by depressing the brake pedal.
- The Cruise Control system or Smart Cruise Control system is activated.



The selected regenerative braking level is displayed on the instrument cluster.

Initial setting of the regenerative braking level and adjustable range vary according to the selected Drive mode.

Drive mode	Initial setting	Adjustable Range
ECO+	2	0-3
ECO	2	0-3
COMFORT	1	0-3
SPORT	1	0-3

For more details, refer to "Drive Mode Integrated Control System" in this chapter.

One pedal driving

The driver can stop the vehicle by pulling and holding the left side paddle shifter.

Operating Conditions

The system enters the operating condition when the conditions below are met:

- The driver's door is closed.
- The driver's seat belt is fastened.

To operate:

- Pull and hold the left side paddle shifter while coasting.
- When the vehicle speed is above 3 km/h, release the paddle shifter to return to the previously set level.
- When the vehicle speed is below 3 km/h, the function maintains control to stop the vehicle even though the paddle shifter is released.
- While the One pedal driving is in activation, the driver can control the vehicle stopping position using the accelerator pedal.

Automatic engagement of EPB

After the vehicle is stopped by the One Pedal Driving function, EPB is automatically engaged when any of these conditions occur:

- The driver's door is open
- The driver's seatbelt is unfastened.
- The hood is open
- The tailgate is open.
- 5 minutes have passed after the vehicle has stopped.
- The system operation is limited due to other reasons.

WARNING

Stopping the vehicle may not be possible according to the vehicle and road conditions. Pay attention to the road condition ahead and apply the brake if necessary.

BRAKING SYSTEM

Power brakes

Your vehicle has power-assisted brakes that adjust automatically through normal usage.

In the event of a vehicle power failure, the power assist for the brakes will not work. You can still stop your vehicle, but it will require greater force and increased pedal travel than normal. The stopping distance, however, will be longer than with power brakes.

Information

- When the brake pedal is depressed under certain driving conditions or weather conditions, you may temporarily hear a noise. This is normal and does not indicate a problem with your brakes.
- While driving on a road with deicing chemicals, brake noise or abnormal tire wear may occur due to deicing chemicals. In a safe traffic condition, additionally apply the brakes to remove deicing chemicals on the brake discs and pads.

WARNING

Take the following precautions:

- Do not drive with your foot resting on the brake pedal. This will create abnormal high brake temperatures, excessive brake lining and pad wear, and increased stopping distances.
- When descending down a long or steep hill, use the paddle shifter (left side lever) to increase regenerative braking in order to control your speed without using the brake pedal excessively. Applying the brakes continuously will cause the brakes to overheat and could result in a temporary loss of braking performance.

- Wet brakes may impair the vehicle's ability to safely slow down; the vehicle may also pull to one side when the brakes are applied. Applying the brakes lightly will indicate whether they have been affected in this way. Always test your brakes in this fashion after driving through deep water. To dry the brakes, lightly tap the brake pedal to heat up the brakes while maintaining a safe forward speed until brake performance returns to normal. Avoid driving at high speeds until the brakes function correctly.

NOTICE

- Do not continue depressing the brake pedal if the "  " indicator is OFF. The battery may be discharged.
- Noise and vibration generated during braking is normal.
- Under normal operation, electric brake pump noise and motor vibration may occur temporarily in below cases.
 - When the pedal is depressed suddenly.
 - When the pedal is repeatedly depressed in short intervals.
 - When the ABS function is activated while braking.

Disc brakes wear indicator

When your brake pads are worn and new pads are required, you will hear a high pitched warning sound from your front or rear brakes. You may hear this sound come and go or it may occur whenever you depress the brake pedal.

NOTICE

To avoid costly brake repairs, do not continue to drive with worn brake pads.

Information

Always replace brake pads as complete front or rear axle sets.

Electronic parking brake (EPB)

Applying the parking brake



To apply the EPB (Electronic Parking Brake):

1. Depress the brake pedal.
 2. Pull the EPB switch upwards.
- Make sure the Parking Brake Warning Light comes on.

With the Auto Hold feature enabled, the EPB is automatically applied when the vehicle is shut off.

However, if Auto Hold is OFF when the the vehicle is turned off, the EPB will not be applied.

⚠ WARNING

To reduce the risk of **SERIOUS INJURY** or **DEATH**, do not operate the parking brake while the vehicle is moving except in an emergency situation. It could damage the brake system and lead to an accident.

Releasing the parking brake



To release the EPB (Electronic Parking Brake), press the EPB switch in the following condition:

- Have the START/STOP button in the ON position.
- Depress the brake pedal.

Make sure the Parking Brake Warning Light goes off.

To release EPB (Electronic Parking Brake) automatically:

- Gear in P (Park)
With the vehicle in the ready (🚗) mode depress the brake pedal and shift out of P (Park) to R (Reverse) or D (Drive).
- Gear in N (Neutral)
With the vehicle in the ready (🚗) mode depress the brake pedal and shift out of N (Neutral) to R (Reverse) or D (Drive).
- Under the following conditions
 1. Start the vehicle.
 2. Fasten the driver's seat belt.
 3. Close the driver's door, hood and tailgate.
 4. Depress the accelerator pedal while the gear is in D (Drive) or R (Reverse).

The Parking Brake Warning Light should be turned off when the EPB is released.

i Information

- For your safety, you can engage the EPB even though the START/STOP button is in the OFF position, but you cannot release it.
- For your safety, depress the brake pedal and release the parking brake manually with the EPB switch when you drive downhill or when backing up the vehicle.

NOTICE

- If the parking brake warning light is still on even though the EPB has been released, we recommend that the system be checked at an authorized HYUNDAI dealer.
- Do not drive your vehicle with the EPB applied. It may cause excessive brake pad and brake rotor wear.

EPB (Electronic Parking Brake) may be automatically applied when:

- Requested by other systems
- If the driver turns the vehicle off while Auto Hold is operating, EPB will be automatically applied.

Warning messages



To release EPB, close the doors, hood and tailgate and fasten seatbelt

A warning will sound and a message will appear in the following conditions.

- If you try to drive with the EPB applied.
- If the driver's seat is not fastened, and you try to release EPB.
- If the driver's door is opened, and you try to release EPB.
- If the hood is opened with the gear in D (Drive)/R (Reverse) and you try to release EPB.

- If the tailgate is opened with the gear in D (Drive)/R (Revers) and you try to release EPB.
- If there is a problem with the vehicle.

If the situation occurs, depress the brake pedal and release EPB by pressing the EPB switch.

WARNING

- To prevent unintentional movement when stopped and leaving the vehicle, do not use the P (Park) position in place of the parking brake. Set the parking brake and make sure the vehicle is securely positioned in P (Park).
- Never allow anyone who is unfamiliar with the vehicle to touch the parking brake. If the parking brake is released unintentionally, serious injury may occur.

- All vehicles should always have the parking brake fully engaged when parking to avoid inadvertent movement of the car which can injure occupants or pedestrians.

NOTICE

- A click sound may be heard while operating or releasing the EPB, but these conditions are normal and indicate that the EPB is functioning properly.
- When leaving your keys with a parking lot attendant or valet, make sure to inform him/her how to operate the EPB.
- The EPB may malfunction if you drive with the EPB applied.
- When you automatically release EPB by depressing the accelerator pedal, depress it slowly.

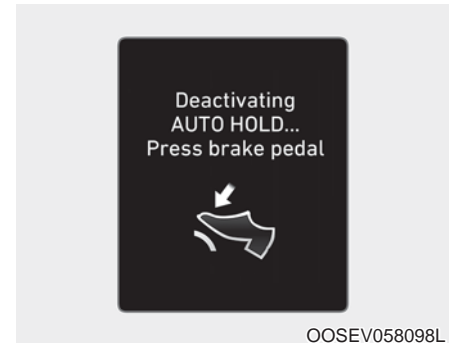

Deactivating AUTO HOLD... Press brake pedal

When the conversion from Auto Hold to EPB is not working properly a warning will sound and a message will appear.



OOSEV058099L

Parking brake automatically applied

If the EPB is applied while Auto Hold is activated, a warning will sound and a message will appear.

EPB malfunction indicator



OOSEV058017

This warning light illuminates if the START/STOP button is changed to the ON position and goes off in approximately 3 seconds if the system is operating normally.

If the EPB malfunction indicator remains on, comes on while driving, or does not come on when the START/STOP button is changed to the ON position, this indicates that the EPB may have malfunctioned.

If this occurs, we recommend that the system be checked by an authorized HYUNDAI dealer.

The EPB malfunction indicator may illuminate when the ESC (Electronic Stability Control) indicator comes on to indicate that the ESC is not working properly, but it does not indicate a malfunction of the EPB.

NOTICE

- If the EPB warning light is still on, we recommend that the system be checked by an authorized HYUNDAI dealer.
- If the parking brake warning light does not illuminate or blinks even though the EPB switch was pulled up, the EPB may not be applied.
- If the parking brake warning light blinks when the EPB warning light is on, press the switch, then pull it up. Once more press it back to its original position and pull it back up. If the EPB warning does not go off, we recommend that the system be checked by an authorized HYUNDAI dealer.

Emergency braking

If there is a problem with the brake pedal while driving, emergency braking is possible by pulling up and holding the EPB switch. Braking is possible only while you are holding the EPB switch. However, braking distance will be longer than normal.

WARNING

Do not operate the parking brake while the vehicle is moving except in an emergency situation. It could damage the brake system and lead to a severe accident.

Information

During emergency braking, the parking brake warning light will illuminate to indicate that the system is operating.

NOTICE

If you continuously notice a noise or burning smell when the EPB is used for emergency braking, we recommend that the system be checked by an authorized HYUNDAI dealer.

When the EPB (Electronic Parking Brake) does not release

If the EPB does not release normally, we recommend that you contact an authorized HYUNDAI dealer by loading the vehicle on a flatbed tow truck and have the system checked.

Parking brake warning light



Check the Parking Brake Warning Light by placing the START/STOP button to the ON position ( indicator off).

This light will be illuminated when the parking brake is applied with the START/STOP button in the START or ON position.

Before driving, be sure the parking brake is released and the Brake Warning Light is OFF.

If the Parking Brake Warning Light remains on after the parking brake is released while the vehicle is in the ready () mode, there may be a malfunction in the brake system. Immediate attention is necessary.

If at all possible, cease driving the vehicle immediately. If that is not possible, use extreme caution while operating the vehicle and only continue to drive the vehicle until you can reach a safe location.

Auto hold

The Auto Hold maintains the vehicle in a standstill even though the brake pedal is not depressed after the driver brings the vehicle to a complete stop by depressing the brake pedal.

To apply :

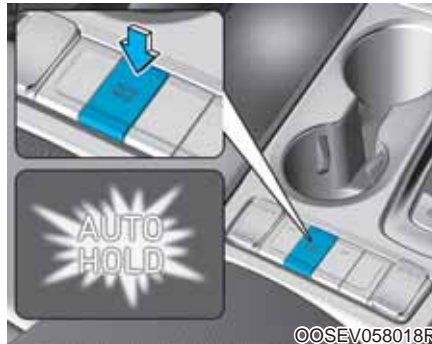

1. With the driver's door, hood and tailgate closed, depress the brake pedal and then press the [AUTO HOLD] switch. The white AUTO HOLD indicator will come on and the system will be in the standby position.

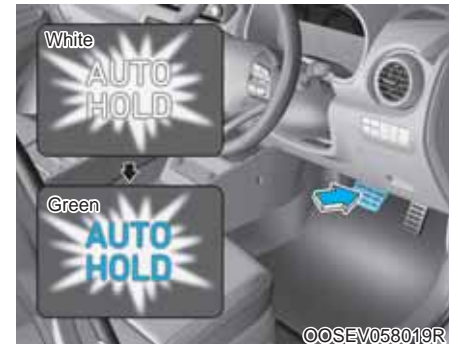

2. When you stop the vehicle completely by depressing the brake pedal, the Auto Hold maintains the brake pressure to hold the vehicle stationary. The indicator changes from white to green.
3. The vehicle will remain stationary even if you release the brake pedal.
4. If EPB is applied, Auto Hold will be released.

To release :

- If you press the accelerator pedal with the gear in D (Drive) or R (Reverse), the Auto Hold will be released automatically and the vehicle will start to move. The AUTO HOLD indicator changes from green to white.
- If the vehicle is restarted using the cruise control toggle switch (RES+ or SET-) while Auto Hold and cruise control is operating, the Auto Hold will be released regardless of accelerator pedal operation. The AUTO HOLD indicator changes from green to white (if equipped with cruise control system).

WARNING

When the AUTO HOLD is automatically released by depressing the accelerator pedal, always take a look around your vehicle.

Slowly depress the accelerator pedal for a smooth start.

To cancel :

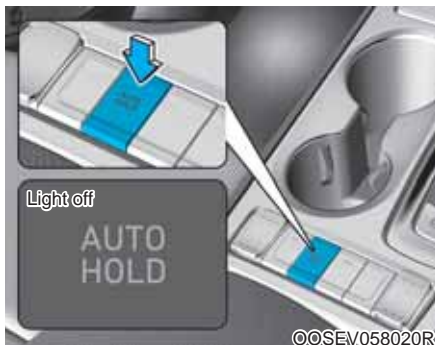

1. Depress the brake pedal.
2. Press the [AUTO HOLD] switch.

The AUTO HOLD indicator will turn off.

WARNING

To prevent, unexpected and sudden vehicle movement, ALWAYS press your foot on the brake pedal to cancel Auto Hold before you:

- Drive downhill.
- Park the vehicle.
- Drive the vehicle in R (Reverse)

Information

- The Auto Hold does not operate when:
 - The driver's door is opened
 - The hood is opened
 - The tailgate is opened
 - The gear is in P (Park)
 - The EPB is applied
- For your safety, the Auto Hold automatically switches to EPB in such cases:
 - The driver's door is opened
 - The hood is opened
 - The tailgate is opened
 - The vehicle stops for more than 10 minutes
 - The vehicle stands on a steep slope
 - The vehicle moves several times

In these cases, the parking brake warning light comes on, the AUTO HOLD indicator changes from green to white, and a warning sounds and a message will appear to inform you that EPB has been automatically engaged. Before driving again, depress the brake pedal, check the surrounding area near your vehicle and release the parking brake manually with the EPB switch.

- While operating Auto Hold, you may hear mechanical noise. However, it is normal operating noise.

NOTICE

If the AUTO HOLD indicator changes to yellow, the Auto Hold is not working properly. We recommend that you contact an authorized HYUNDAI dealer.

⚠ WARNING

- Depress the accelerator pedal slowly when you start the vehicle.
- For your safety, cancel the Auto Hold when you drive downhill, back up the vehicle or park the vehicle.

NOTICE

If there is a malfunction with the driver's door or hood open detection system, the Auto Hold may not work properly.

We recommend that you contact an authorized HYUNDAI dealer.

Warning messages

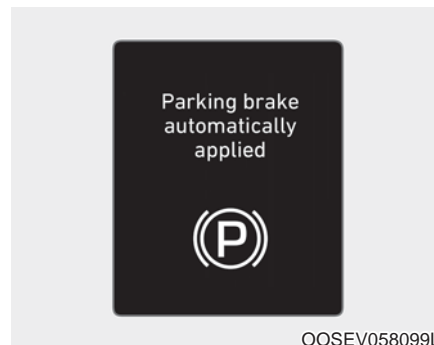

Parking brake automatically applied

When the EPB is applied from Auto Hold, a warning will sound and a message will appear.

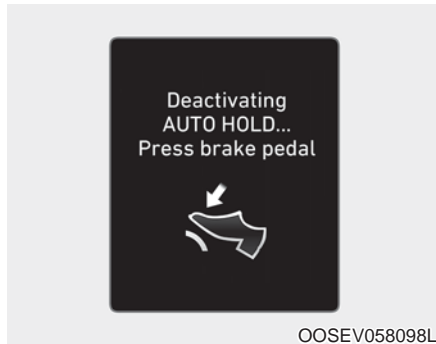

**Deactivating AUTO HOLD...
Press brake pedal**

When the conversion from Auto Hold to EPB is not working properly a warning will sound and a message will appear.

When this message is displayed, the Auto Hold and EPB may not operate.

For your safety, depress the brake pedal.

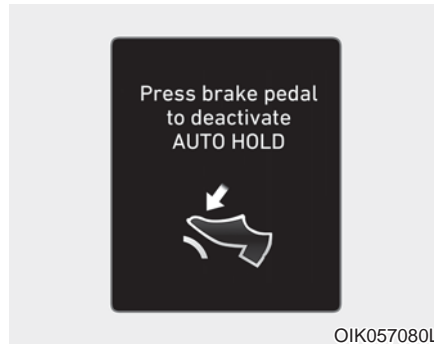

**Press brake pedal to deactivate
AUTO HOLD**

If you did not apply the brake pedal when you release the Auto Hold by pressing the [AUTO HOLD] switch, a warning will sound and a message will appear.



**AUTO HOLD conditions not met.
Close door, hood and tailgate**

When you press the [AUTO HOLD] switch, if the driver's door, hood and tailgate are not closed, a warning will sound and a message will appear on the LCD display.

Press the [AUTO HOLD] switch after closing the driver's door, hood and tailgate.

Anti-lock Brake System (ABS)

WARNING

An Anti-Lock Braking System (ABS) or an Electronic Stability Control (ESC) system will not prevent accidents due to improper or dangerous driving maneuvers. Even though vehicle control is improved during emergency braking, always maintain a safe distance between you and objects ahead of you. Vehicle speeds should always be reduced during extreme road conditions. The braking distance for cars equipped with ABS or ESC may be longer than for those without these systems in the following road conditions.

Drive your vehicle at reduced speeds during the following conditions:

- Rough, gravel or snow-covered roads.

- On roads where the road surface is pitted or has different surface height.
- Tire chains are installed on your vehicle.

The safety features of an ABS or ESC equipped vehicle should not be tested by high speed driving or cornering. This could endanger the safety of yourself or others.

ABS is an electronic braking system that helps prevent a braking skid. ABS allows the driver to steer and brake at the same time.

Using ABS

To obtain the maximum benefit from your ABS in an emergency situation, do not attempt to modulate your brake pressure and do not try to pump your brakes. Depress your brake pedal as hard as possible.

When you apply your brakes under conditions which may lock the wheels, you may hear sounds from the brakes, or feel a corresponding sensation in the brake pedal. This is normal and it means your ABS is active.

ABS does not reduce the time or distance it takes to stop the vehicle.

Always maintain a safe distance from the vehicle in front of you.

ABS will not prevent a skid that results from sudden changes in direction, such as trying to take a corner too fast or making a sudden lane change. Always drive at a safe speed for the road and weather conditions.

ABS cannot prevent a loss of stability. Always steer moderately when braking hard. Severe or sharp steering wheel movement can still cause your vehicle to veer into oncoming traffic or off the road.

On loose or uneven road surfaces, operation of the anti-lock brake system may result in a longer stopping distance than for vehicles equipped with a conventional brake system.

The ABS warning light (ⓘ) will stay on for several seconds after the START/STOP button is in the ON position. During that time, the ABS will go through self-diagnosis and the light will go off if everything is normal. If the light stays on, you may have a problem with your ABS. We recommend that you contact an authorized HYUNDAI dealer as soon as possible.

WARNING

If the ABS warning light (ⓘ) is on and stays on, you may have a problem with the ABS. Your power brakes will work normally. To reduce the risk of serious injury or death, we recommend that you contact your HYUNDAI dealer as soon as possible.

NOTICE

When you drive on a road having poor traction, such as an icy road, and apply your brakes continuously, the ABS will be active continuously and the ABS warning light (ⓘ) may illuminate. Pull your car over to a safe place and turn the vehicle off.

Restart the vehicle. If the ABS warning light is off, then your ABS system is normal.

Otherwise, you may have a problem with your ABS system. We recommend that you contact an authorized HYUNDAI dealer as soon as possible.

Information

When you jump start your vehicle because of a drained battery, the ABS warning light (ⓘ) may turn on at the same time. This happens because of the low battery voltage. It does not mean your ABS is malfunctioning. Have the battery recharged before driving the vehicle.

Electronic Stability Control (ESC)



The Electronic Stability Control (ESC) system helps to stabilize the vehicle during cornering maneuvers. ESC checks where you are steering and where the vehicle is actually going. ESC applies braking pressure to any one of the vehicle's brakes and intervenes in the electric vehicle control system to assist the driver with keeping the vehicle on the intended path. It is not a substitute for safe driving practices. Always adjust your speed and driving to the road conditions.

WARNING

Never drive too fast for the road conditions or too quickly when cornering. The ESC system will not prevent accidents.

Excessive speed in turns, abrupt maneuvers, and hydroplaning on wet surfaces can result in severe accidents.

ESC operation

ESC ON condition

When the START/STOP button is in the ON position, the ESC and the ESC OFF indicator lights illuminate for approximately three seconds. After both lights go off, the ESC is enabled.

When operating



When the ESC is in operation, the ESC indicator light blinks:

- When you apply your brakes under conditions which may lock the wheels, you may hear sounds from the brakes, or feel a corresponding sensation in the brake pedal. This is normal and it means your ESC is active.
- When the ESC activates, the vehicle may not respond to the accelerator as it does under routine conditions.
- If the Cruise Control was in use when the ESC activates, the Cruise Control automatically disengages. The Cruise Control can be reengaged when the road conditions allow. **See "Cruise Control System" later in this chapter (if equipped).**

ESC OFF condition



To cancel ESC operation :

• State 1



Press the ESC OFF button briefly. The ESC OFF indicator light and message "Traction Control disabled" will illuminate. In this state, the traction control function of ESC is disabled, but the brake control function of ESC still operates.

• State 2



Press and hold the ESC OFF button continuously for more than 3 seconds. The ESC OFF indicator light and message "Traction & Stability Control disabled" illuminates and a warning chime sounds. In this state, both the traction control function of ESC and the brake control function of ESC are disabled.

If the START/STOP button is placed to the OFF position when ESC is off, ESC remains off. Upon restarting the vehicle, the ESC will automatically turn on again.

Indicator lights

- ESC indicator light (blinks)



- ESC OFF indicator light (comes on)



When the START/STOP button is pressed to the ON position, the ESC indicator light illuminates, then goes off if the ESC system is operating normally.

The ESC indicator light blinks whenever the ESC is operating.

If the ESC indicator light stays on, your vehicle may have a malfunction with the ESC system. When this warning light illuminates we recommend that the vehicle be checked by an authorized HYUNDAI dealer as soon as possible.

The ESC OFF indicator light comes on when the ESC is turned off with the button.

WARNING

When the ESC is blinking, this indicates the ESC is active:

Drive slowly and NEVER attempt to accelerate. NEVER turn the ESC off while the ESC indicator light is blinking or you may lose control of the vehicle resulting in an accident.

NOTICE

Driving with wheels and tires with different sizes may cause the ESC system to malfunction. Before replacing tires, make sure all four tires and wheels are the same size. Never drive the vehicle with different sized wheels and tires installed.

ESC OFF usage

When Driving

The ESC OFF mode should only be used briefly to help free the vehicle if stuck in snow or mud, by temporarily stopping operation of the ESC, to maintain wheel torque.

To turn ESC off while driving, press the ESC OFF button while driving on a flat road surface.

NOTICE

- Do not allow wheel(s) of one axle to spin excessively while the ESC, ABS, and parking brake warning lights are displayed. The repairs would not be covered by the vehicle warranty. Reduce vehicle power and do not spin the wheel(s) excessively while these lights are displayed.
- When operating the vehicle on a dynamometer, make sure the ESC is turned off (ESC OFF light illuminated).

Information

Turning the ESC off does not affect ABS or standard brake system operation.

Vehicle Stability Management (VSM)

The Vehicle Stability Management (VSM) is a function of the Electronic Stability Control (ESC) system. It helps ensure the vehicle stays stable when accelerating or braking suddenly on wet, slippery and rough roads where traction over the four tires can suddenly become uneven.

WARNING

Take the following precautions when using the Vehicle Stability Management (VSM):

- ALWAYS check the speed and the distance to the vehicle ahead. The VSM is not a substitute for safe driving practices.
- Never drive too fast for the road conditions. The VSM system will not prevent accidents. Excessive speed in bad weather, slippery and uneven roads can result in severe accidents.

VSM operation

When operating

When you apply your brakes under conditions which may activate the ESC, you may hear sounds from the brakes, or feel a corresponding sensation in the brake pedal. This is normal and it means your VSM is active.

i Information

The VSM does not operate when:

- Driving on a banked road such as a gradient or incline.
- Driving in reverse.
- The ESC OFF indicator light is on.
- The EPS (Electric power steering) warning light (⊖!) is on or blinks.

⚠ WARNING

If the ESC indicator light (⚠) or EPS warning light (⊖!) stays on or blinks, your vehicle may have a malfunction with the VSM system. When the warning light illuminates we recommend that the vehicle be checked by an authorized HYUNDAI dealer as soon as possible.

NOTICE

Driving with wheels and tires with different sizes may cause the ESC system to malfunction. Before replacing tires, make sure all four tires and wheels are the same size. Never drive the vehicle with different sized tires and wheels installed.

Hill-Start Assist Control (HAC)

The Hill-Start Assist Control (HAC) helps prevent the vehicle from rolling backwards when starting a vehicle from a stop on a hill. The system operates the brakes automatically for approximately 5 seconds and releases the brake after 5 seconds or when the accelerator pedal is depressed.

⚠ WARNING

Always be ready to depress the accelerator pedal when starting off on an incline. The HAC activates only for approximately 5 seconds.

i Information

- The HAC does not operate when the gear is in P (Park) or N (Neutral).
- The HAC activates even when the ESC (Electronic Stability Control) is off. However, it does not activate, when the ESC does not operate normally.

Good braking practices

WARNING

Whenever leaving the vehicle or parking, always come to a complete stop and continue to depress the brake pedal. Shift to the P (Park) position, then apply the parking brake, and place the START/STOP button in the OFF position.

Vehicles parked with the parking brake not applied or not fully engaged may roll inadvertently and may cause injury to the driver and others. ALWAYS apply the parking brake before exiting the vehicle.

Wet brakes can be dangerous! The brakes may get wet if the vehicle is driven through standing water or if it is washed. Your vehicle will not stop as quickly if the brakes are wet. Wet brakes may cause the vehicle to pull to one side.

To dry the brakes, apply the brakes lightly until the braking action returns to normal. If the braking action does not return to normal, stop as soon as it is safe to do so and we recommend that you call an authorized HYUNDAI dealer for assistance.

DO NOT drive with your foot resting on the brake pedal. Even light, but constant pedal pressure can result in the brakes overheating, brake wear, and possibly even brake failure.

If a tire goes flat while you are driving, apply the brakes gently and keep the vehicle pointed straight ahead while you slow down. When you are moving slowly enough for it to be safe to do so, pull off the road and stop in a safe location.

Keep your foot firmly on the brake pedal when the vehicle is stopped to prevent the vehicle from rolling forward.

DRIVE MODE INTEGRATED CONTROL SYSTEM

Drive mode



The drive mode may be selected according to the driver's preference or road condition.

- The mode changes, as below, whenever the DRIVE MODE button is pressed.

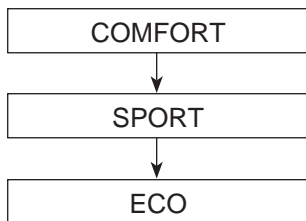

- Press and hold the DRIVE MODE button to select ECO+ mode.

Initial setting for each Drive Mode

Drive mode	COMFORT	SPORT	ECO	ECO+ *1
Feature	Normal driving mode	Sporty driving mode	Optimal for eco-driving	Ultra power saving driving mode
Button activation	Press	Press	Press	Press and hold
Indicator on the cluster	-	SPORT	ECO	ECO+
Air conditioner/heater system control	COMFORT (ECO/COMFORT) *2	COMFORT (ECO/COMFORT) *2	ECO	Off
Speed limit	- (90~120 km/h) *2	-	-	Below 90 km/h
Regenerative braking level	1 (1~3) *2	1 (1~3) *2	2 (1~3) *2	2

*1 : Change to ECO+ mode

- Distance to empty may not change when the air conditioner/heater system is off. However, actual distance may be extended.
- Air conditioner/heater system turns off (except the defroster) but you may turn it on if necessary.
- When the drive mode is switched from the ECO+ mode to a different mode, it is changed to air conditioner/heater operation status of the ECO mode.
- The speed limit is automatically deactivated when the Smart Cruise Control system is in activation or the accelerator pedal is depressed to the end. If speed limit function is deactivated by depressing the accelerator pedal, the speed limit function will reactivate when vehicle speed is lower than the set speed limit. Also, the speed is changed to the speed set at ECO mode when the drive mode switches from the ECO+ mode to ECO mode.

*2 : It is possible to set the driving condition for each drive mode (except the ECO+ mode) at the drive mode setting in the Audio and AVN system. For more information, refer to the separately supplied manual.

CRUISE CONTROL

Cruise Control operation

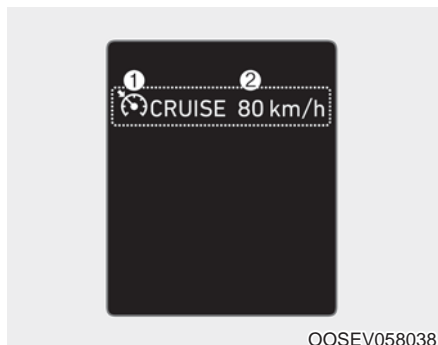

OOSEV058038

1. Cruise indicator
2. Set speed

The Cruise Control system allows you to drive at speeds above 30 km/h (20 mph) without depressing the accelerator pedal.

WARNING

Take the following precautions:

- Always set the vehicle speed under the speed limit in your country.
- If the Cruise Control is left on, (cruise indicator light in the instrument cluster is illuminated) the Cruise Control can be activated unintentionally. Keep the Cruise Control system off (cruise indicator light OFF) when the Cruise Control is not in use, to avoid inadvertently setting a speed.
- Use the Cruise Control system only when traveling on open highways in good weather.
- Do not use the Cruise Control when it may be unsafe to keep the vehicle at a constant speed:
 - When driving in heavy traffic or when traffic conditions make it difficult to drive at a constant speed

- When driving on rainy, icy, or snow-covered roads
- When driving on hilly or windy roads
- When driving in windy areas
- When driving with limited view (possibly due to bad weather such as fog, snow, rain and sandstorm)

Information

- During normal cruise control operation, when the SET switch is activated or reactivated after applying the brakes, the cruise control will energize after approximately 3 seconds. This delay is normal.
- Before activating the cruise control function, the system will check to verify that the brake switch is operating normally. Depress the brake pedal at least once after pressing the START/STOP button to the ON position or starting the vehicle.

Cruise control switch



 MODE : Changes Cruise control mode.



RES+ : Resumes or increases speed limit control speed.

SET- : Sets or decreases speed limit control speed.

CANCEL : Cancels set speed limit.

To set Cruise Control speed



1. Press the  MODE button on the steering wheel to turn the system on. The cruise indicator will illuminate.

2. Accelerate to the desired speed, which must be more than 30 km/h (20 mph).



3. Push the toggle switch (1) down (SET-), and release it. The set speed on the LCD display will illuminate.

4. Release the accelerator pedal.

Information

On a steep slope, the vehicle may slightly slow down or speed up, while driving uphill or downhill.

To increase Cruise Control speed



- Push the toggle switch (1) up (RES+) and hold it, while monitoring the set speed on the instrument cluster.

Release the toggle switch when the desired speed is shown and the vehicle will accelerate to that speed.

- Push the toggle switch (1) up (RES+) and release it immediately. The cruising speed will increase 1.0 km/h (1.0 mph) each time the toggle switch is operated in this manner.
- Depress the accelerator pedal. When the vehicle attains the desired speed, push the toggle switch (1) down (SET-).

To decrease Cruise Control speed



- Push the toggle switch (1) down (SET-) and hold it. Your vehicle will gradually slow down. Release the toggle switch at the speed you want to maintain.
- Push the toggle switch (1) down (SET-) and release it immediately. The cruising speed will decrease 1.0 km/h (1.0 mph) each time the toggle switch is operated in this manner.

- Lightly tap the brake pedal. When the vehicle attains the desired speed, push the toggle switch (1) down (SET-).

To temporarily accelerate with the Cruise Control ON

Depress the accelerator pedal. When you take your foot off the accelerator, the vehicle will return to the previously set speed.



If you push the toggle switch down (SET-) at the increased speed, the Cruise Control will maintain the increased speed.

Cruise Control will be canceled when:



- Depressing the brake pedal.
- Pressing the O (CANCEL) button located on the steering wheel.
- The vehicle is shifted into N (Neutral).
- Decreasing the vehicle speed to less than the memory speed by approximately 20 km/h (12 mph).
- Decreasing the vehicle speed to less than approximately 30 km/h (20 mph).
- The ESC (Electronic Stability Control) is operating.

***i* Information**

Each of the above actions will cancel Cruise Control operation (the set speed on the instrument cluster will go off), but only pressing the  MODE button will turn the system off. If you wish to resume Cruise Control operation, push the toggle switch up (RES+) located on your steering wheel. You will return to your previously preset speed, unless the system was turned off using the  MODE button.

To resume preset Cruising speed



Push the toggle switch (1) up (RES+). If the vehicle speed is over 30 km/h (20 mph), the vehicle will resume the preset speed.

To turn Cruise Control off



- Press the MODE button (The indicator light will go off.).
 - With the Cruise Control on, pressing the button once will turn Off the Cruise Control and turn on the Speed Limit Control.
 - With the Cruise Control off and Speed Limit Control on, pressing the button will turn off both system.

i Information

The mode changes, as below, whenever the MODE button is pressed.



WINTER DRIVING

The severe weather conditions of winter quickly wear out tires and cause other problems. To minimize winter driving problems, you should take the following suggestions:

Information

Information for Snow Tires and Tire Chains in the national language (Bulgarian, Hungarian, Icelandic, Polish) is provided in the Appendix.

Snow or icy conditions

You need to keep sufficient distance between your vehicle and the vehicle in front of you.

Apply the brakes gently. Speeding, rapid acceleration, sudden brake applications, and sharp turns are potentially very hazardous practices. During deceleration, use the paddle shifter (left side lever) to increase regenerative braking, but avoid adjusting it to level 3 (steering may be difficult). Sudden brake applications on snowy or icy roads may cause the vehicle to skid.

To drive your vehicle in deep snow, it may be necessary to use snow tires or to install tire chains on your tires.

Always carry emergency equipment. Some of the items you may want to carry include tire chains, tow straps or chains, a flashlight, emergency flares, sand, a shovel, jumper cables, a window scraper, gloves, ground cloth, coveralls, a blanket, etc.

Snow tires

WARNING

Snow tires should be equivalent in size and type to the vehicle's standard tires. Otherwise, the safety and handling of your vehicle may be adversely affected.

If you mount snow tires on your vehicle, make sure to use radial tires of the same size and load range as the original tires. Mount snow tires on all four wheels to balance your vehicle's handling in all weather conditions. The traction provided by snow tires on dry roads may not be as high as your vehicle's original equipment tires. Check with the tire dealer for maximum speed recommendations.

Information

Do not install studded tires without first checking local and municipal regulations for possible restrictions against their use.

Tire chains



Since the sidewalls of radial tires are thinner than other types of tires, they may be damaged by mounting some types of tire chains on them. Therefore, the use of snow tires is recommended instead of tire chains. Do not mount tire chains on vehicles equipped with aluminum wheels; if possible use a wire type chain. If tire chains must be used, use genuine HYUNDAI parts and install the tire chain after reviewing the instructions provided with the tire chains. Damage to your vehicle caused by improper tire chain use is not covered by your vehicle manufacturer's warranty.

WARNING

The use of tire chains may adversely affect vehicle handling:

- Drive less than 30 km/h (20 mph) or the chain manufacturer's recommended speed limit, whichever is lower.
- Drive carefully and avoid bumps, holes, sharp turns, and other road hazards, which may cause the vehicle to bounce.
- Avoid sharp turns or locked wheel braking.

Information

- Install tire chains only in pairs and on the front tires. It should be noted that installing tire chains on the tires will provide a greater driving force, but will not prevent side skids.
- Do not install studded tires without first checking local and municipal regulations for possible restrictions against their use.

Chain Installation

When installing tire chains, follow the manufacturer's instructions and mount them as tightly possible. Drive slowly (less than 30 km/h (20 mph)) with chains installed. If you hear the chains contacting the body or chassis, stop and tighten them. If they still make contact, slow down until the noise stops. Remove the tire chains as soon as you begin driving on cleared roads.

When mounting snow chains, park the vehicle on level ground away from traffic. Turn on the vehicle Hazard Warning Flasher and place a triangular emergency warning device behind the vehicle (if available). Always place the vehicle in P (Park), apply the parking brake and turn off the vehicle before installing snow chains.

NOTICE

When using tire chains:

- **Wrong size chains or improperly installed chains can damage your vehicle's brake lines, suspension, body and wheels.**
- **Use SAE "S" class or wire chains.**
- **If you hear noise caused by chains contacting the body, retighten the chain to prevent contact with the vehicle body.**
- **To prevent body damage, retighten the chains after driving 0.5~1.0 km (0.3~0.6 miles).**
- **Do not use tire chains on vehicles equipped with aluminum wheels. If unavoidable, use a wire type chain.**
- **Use wire chains less than 12 mm (0.47 in) thick to prevent damage to the chain's connection.**

Winter precautions

Check battery and cables

The winter temperature increases the battery consumption. **Inspect the battery and cables, as specified in the chapter 7.** The battery charging level can be checked by an authorized HYUNDAI dealer or in a service station.

Change to "winter weight" oil if necessary

In some regions during winter, it is recommended to use the "winter weight" oil with lower viscosity. For further information, refer to the chapter 8. When you are not sure about a type of winter weight oil, consult an authorized HYUNDAI dealer.

To prevent locks from freezing

To prevent the locks from being frozen, spray approved de-icing fluid or glycerin into key holes. When a lock opening is already covered with ice, spray approved de-icing fluid over the ice to remove it. When an internal part of a lock freezes, try to thaw it with a heated key. Carefully use the heated key to avoid an injury.

Use approved window washer anti-freeze solution in system

To prevent the window washer from being frozen, add authorized window washer anti-freeze solution, as specified on the window washer container. Window washer anti-freeze solution is available from an authorized HYUNDAI dealer, and so are the most vehicle accessory outlets. Do not use coolant or other types of anti-freeze solution to prevent any damage to the vehicle paint.

Do not let your parking brake freeze

Under some conditions your parking brake can freeze in the engaged position. This is most likely to happen when there is an accumulation of snow or ice around or near the rear brakes or if the brakes are wet. When there is the risk that your parking brake may freeze, temporarily shift to P (Park). Also, block the rear wheels in advance, so the vehicle may not roll. Then, release the parking brake.

Do not let ice and snow accumulate underneath

Under some conditions, snow and ice can build up under the fenders and interfere with the steering. When driving in such conditions during the severe winter, you should check underneath the vehicle on a regular basis, so that moving the front wheels and the steering components is unblocked.

Carry emergency equipment

In accordance with weather conditions, you should carry appropriate emergency equipment, while driving. Some of the items you may want to carry include tire chains, tow straps or chains, flashlight, emergency flares, sand, shovel, jumper cables, window scraper, gloves, ground cloth, coveralls, blanket, etc.

Do not place objects or materials in the motor compartment

Putting objects or materials in the motor compartment may cause a vehicle failure, because those may block cooling the parts in the motor compartment. Such damage will not be covered by the manufacturer's warranty.

VEHICLE WEIGHT

Two labels on your driver's door sill show how much weight your vehicle was designed to carry: the Tire and Loading Information Label and the Certification Label.

Before loading your vehicle, familiarize yourself with the following terms for determining your vehicle's weight ratings, from the vehicle's specifications and the Certification Label:

Base Curb Weight

This is the weight of the vehicle including a full tank of fuel and all standard equipment. It does not include passengers, cargo, or optional equipment.

Vehicle Curb Weight

This is the weight of your new vehicle when you picked it up from your dealer plus any aftermarket equipment.

Cargo Weight

This figure includes all weight added to the Base Curb Weight, including cargo and optional equipment.

GAW (Gross Axle Weight)

This is the total weight placed on each axle (front and rear) - including vehicle curb weight and all payload.

GAWR (Gross Axle Weight Rating)

This is the maximum allowable weight that can be carried by a single axle (front or rear). These numbers are shown on the Certification Label. The total load on each axle must never exceed its GAWR.

GVW (Gross Vehicle Weight)

This is the Base Curb Weight plus actual Cargo Weight plus passengers.

GVWR (Gross Vehicle Weight Rating)

This is the maximum allowable weight of the fully loaded vehicle (including all options, equipment, passengers and cargo). The GVWR is shown on the Certification Label located on the driver's door sill.

Overloading

WARNING

The Gross Axle Weight Rating (GAWR) and the Gross Vehicle Weight Rating (GVWR) for your vehicle are on the Certification Label attached to the driver's (or front passenger's) door. Exceeding these ratings can cause an accident or vehicle damage. You can calculate the weight of your load by weighing the items (and people) before putting them in the vehicle. Be careful not to overload your vehicle.

TRAILER TOWING

We do not recommend using this vehicle for trailer towing.

What to do in an Emergency

Hazard warning flasher	7-2	Towing	7-23
In case of an emergency while driving.....	7-2	Towing service.....	7-23
If the vehicle stalls while driving.....	7-2	Removable towing hook.....	7-24
If the vehicle stalls at a crossroad or crossing	7-2		
If you have a flat tire while driving.....	7-3		
If the vehicle will not start	7-4		
Confirm the EV battery is not low on the charge			
gauge	7-4		
Jump starting	7-4		
If the vehicle overheats	7-8		
Tire Pressure Monitoring System (TPMS)	7-9		
Check tire pressure	7-9		
Tire pressure monitoring system	7-10		
Low tire pressure telltale	7-11		
Low tire pressure position and			
tire pressure telltale	7-11		
TPMS (Tire Pressure Monitoring System)			
malfunction indicator	7-12		
Changing a tire with TPMS.....	7-13		
If you have a flat tire (with spare tire)	7-15		
Jack and tool.....	7-15		
Changing tires.....	7-16		
Jack label	7-21		
EC declaration.....	7-22		

HAZARD WARNING FLASHER

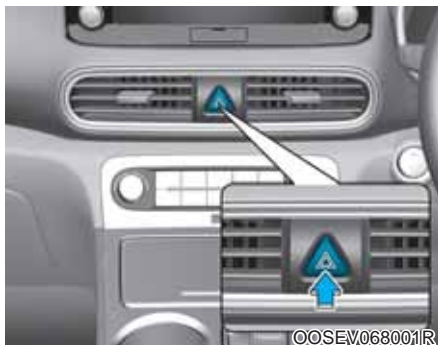

The hazard warning flasher serves as a warning to other drivers to exercise extreme caution when approaching, overtaking, or passing your vehicle.

It should be used whenever emergency repairs are being made or when the vehicle is stopped near the edge of a roadway.

To turn the hazard warning flasher on or off, press the hazard warning flasher button with the START/STOP button in any position. The button is located in the center fascia panel. All turn signal lights will flash simultaneously.

- The hazard warning flasher operates whether your vehicle is running or not.
- The turn signals do not work when the hazard flasher is on.

IN CASE OF AN EMERGENCY WHILE DRIVING

If the vehicle stalls while driving

- Reduce your speed gradually, keeping a straight line. Move cautiously off the road to a safe place.
- Turn on your hazard warning flasher.
- Try to start the vehicle again. If your vehicle will not start, we recommend that you contact an authorized HYUNDAI dealer.

If the vehicle stalls at a crossroad or crossing

If the vehicle stalls at a crossroad or crossing, if safe to do so, shift to the N (Neutral) position and then push the vehicle to a safe location.

If you have a flat tire while driving

If a tire goes flat while you are driving:

- Take your foot off the accelerator pedal and let the vehicle slow down while driving straight ahead. Do not apply the brakes immediately to slow down the vehicle, but use the paddle shifter (left side lever) to increase regenerative braking control. Also, do not attempt to pull off the road as this may cause loss of vehicle control resulting in an accident. When the vehicle has slowed to such a speed that it is safe to do so, brake carefully and pull off the road. Drive off the road as far as possible and park on firm, level ground. If you are on a divided highway, do not park in the median area between the two traffic lanes.
- When the vehicle is stopped, press the hazard warning flasher button, shift to P (Park), apply the parking brake, and place the START/STOP button in the OFF position.
- Have all passengers get out of the vehicle. Be sure they all get out on the side of the vehicle that is away from traffic.
- Follow the instructions provided later in this chapter. (Refer to "If You Have a Flat Tire" provided in this chapter.)

IF THE VEHICLE WILL NOT START

Confirm the EV battery is not low on the charge gauge

- Be sure the gear is in P (Park). The vehicle starts only when the gear is in P (Park).
- Check the 12-volt battery connections to be sure they are clean and tight.
- Turn on the interior light. If the light dims or goes out when you operate the starter, the battery is drained.

Do not push or pull the vehicle to start it. This could cause damage to your vehicle. **See instructions for "Jump Starting" provided in this chapter.**

JUMP STARTING (12V BATTERY)

Jump starting can be dangerous if done incorrectly. Follow the jump starting procedure in this section to avoid serious injury or damage to your vehicle. If in doubt about how to properly jump start your vehicle, we strongly recommend that you have a service technician or towing service do it for you.

WARNING

To prevent **SERIOUS INJURY** or **DEATH** to you or bystanders, always follow these precautions when working near or handling the battery:



Always read and follow instructions carefully when handling a battery.



Wear eye protection designed to protect the eyes from acid splashes.



Keep all flames, sparks, or smoking materials away from the battery.



Hydrogen is always present in battery cells, is highly combustible, and may explode if ignited.



Keep batteries out of reach of children.



Batteries contain sulfuric acid which is highly corrosive. Do not allow acid to contact your eyes, skin or clothing.

If acid gets into your eyes, flush your eyes with clean water for at least 15 minutes and get immediate medical attention. If acid gets on your skin, thoroughly wash the area. If you feel pain or a burning sensation, get medical attention immediately.

- When lifting a plastic-cased battery, excessive pressure on the case may cause battery acid to leak. Lift with a battery carrier or with your hands on opposite corners.
- Do not attempt to jump start your vehicle if your battery is frozen.

- **NEVER** attempt to recharge the battery when the vehicle's battery cables are connected to the battery.
- The electrical ignition system works with high voltage. **NEVER** touch these components with the "🔌" indicator ON or when the START/STOP button is in the ON position.
- The battery may rupture or explode when you jump start with a low or frozen battery.

NOTICE

To prevent damage to your vehicle:

- Only use a 12-volt power supply (battery or jumper system) to jump start your vehicle.
- Do not attempt to jump start your vehicle by push-starting.

⚠ WARNING

While jump starting your vehicle, avoid the positive (+) and negative (-) cables to come in contact. A spark could cause personal injury.

i Information



An inappropriately disposed battery can be harmful to the environment and human health. Dispose of the battery according to your local law(s) or regulations.

Jump starting procedure

1. Position the vehicles close enough that the jumper cables will reach, but do not allow the vehicles to touch.
2. Avoid fans or any moving parts in the motor compartment at all times, even when the vehicles are turned off.
3. Turn off all electrical devices such as radios, lights, air conditioning, etc. Put the vehicles in P (Park) and set the parking brakes. Turn both vehicles OFF.

⚠ CAUTION

Before jump starting, make sure to correctly identify the positive (+) and negative (-) terminals to avoid reverse polarity connections.

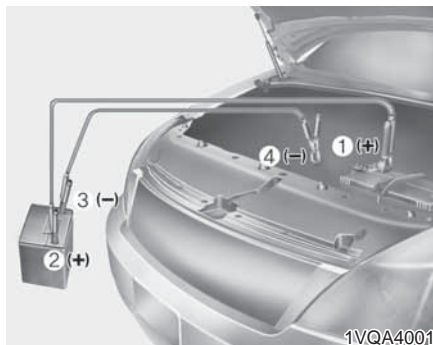

4. Connect the jumper cables in the exact sequence shown in the illustration. First connect one jumper cable to the red, positive (+) jumper terminal of your vehicle (1).
5. Connect the other end of the jumper cable to the red, positive (+) battery/jumper terminal of the assisting vehicle (2).
6. Connect the second jumper cable to the black, negative (-) battery/jumper terminal of the assisting vehicle (3).

7. Connect the other end of the second jumper cable to the black, negative (-) chassis ground of your vehicle (4).

Do not allow the jumper cables to contact anything except the correct battery or jumper terminals or the correct ground. Do not lean over the battery when making connections.

⚠ WARNING

Do not connect the jumper cable to the negative (-) jumper terminal of the discharged battery. A spark could cause the battery to explode and lead to a personal injury or vehicle damage.

8. Start the engine of the assisting vehicle and let it run at approximately 2,000 rpm for a few minutes. Then start your vehicle.

If your vehicle will not start after a few attempts, it probably requires service. In this event please seek qualified assistance. If the cause of your battery discharging is not apparent, have your vehicle checked by an authorized HYUNDAI dealer.

Disconnect the jumper cables in the exact reverse order you connected them:

1. Disconnect the jumper cable from the black, negative (-) chassis ground of your vehicle (4).
2. Disconnect the other end of the jumper cable from the black, negative (-) battery/chassis ground of the assisting vehicle (3).
3. Disconnect the second jumper cable from the red, positive (+) battery/jumper terminal of the assisting vehicle (2).
4. Disconnect the other end of the jumper cable from the red, positive (+) jumper terminal of your vehicle (1).

IF THE VEHICLE OVERHEATS

1. Pull off the road and stop as soon as it is safe to do so.
2. Shift to P (Park) and set the parking brake. If the air conditioning is on, turn it off.
3. If coolant is running out under the vehicle or steam is coming out from the hood, stop the vehicle. Do not open the hood until the coolant has stopped running or the steaming has stopped. If there is no visible loss of coolant and no steam, leave the vehicle running and check to be sure the cooling fan is operating. If the fan is not running, turn the vehicle off.
4. Check for coolant leaking from the radiator, hoses or under the vehicle. (If the air conditioning had been in use, it is normal for cold water to be draining from it when you stop).
5. If coolant is leaking out, turn off the vehicle immediately and we recommend that you call an authorized HYUNDAI dealer for assistance.
6. If you cannot find the cause of the overheating, wait until the radiator temperature has returned to normal. Then, if coolant has been lost, call an authorized HYUNDAI dealer for assistance.

NOTICE

Serious loss of coolant indicates there is a leak in the cooling system and we recommend that the system be checked by an authorized HYUNDAI dealer.

TIRE PRESSURE MONITORING SYSTEM (TPMS) (IF EQUIPPED)



- (1) Low Tire Pressure Telltale/ TPMS Malfunction Indicator
- (2) Low Tire Pressure Position Telltale and Tire Pressure Telltale (Shown on the LCD display)

Check tire pressure (if equipped)



- You can check the tire pressure in the Assist mode on the cluster.
Refer to the "LCD display modes" in chapter 3.
- Tire pressure is displayed after a few minutes of driving after initial vehicle start up.
- If tire pressure is not displayed when the vehicle is stopped, "Drive to display" message will appear. After driving, check the tire pressure.

- The displayed tire pressure values may differ from those measured with a tire pressure gauge.
- You can change the tire pressure unit in the User Settings mode on the LCD display.
 - psi, kpa, bar (**Refer to the "User Settings Mode" in chapter 3**).

Tire pressure monitoring system

WARNING

Over-inflation or under-inflation can reduce tire life, adversely affect vehicle handling, and lead to sudden tire failure that may cause loss of vehicle control resulting in an accident.

Each tire should be checked monthly when cold and inflated to the inflation pressure recommended by the vehicle manufacturer on the vehicle placard or tire inflation pressure label. (If your vehicle has tires of a different size than the size indicated on the vehicle placard or tire inflation pressure label, you should determine the proper tire inflation pressure for those tires.)

As an added safety feature, your vehicle has been equipped with a tire pressure monitoring system (TPMS) that illuminates a low tire pressure telltale when one or more of your tires is significantly under-inflated. Accordingly, when the low tire pressure telltale illuminates, you should stop and check your tires as soon as possible, and inflate them to the proper pressure. Driving on a significantly under-inflated tire causes the tire to overheat and can lead to tire failure.

Under-inflation also reduces fuel efficiency and tire tread life, and may affect the vehicle's handling and stopping ability.

Please note that the TPMS is not a substitute for proper tire maintenance, and it is the driver's responsibility to maintain correct tire pressure, even if under-inflation has not reached the level to trigger illumination of the TPMS low tire pressure telltale.

Your vehicle has also been equipped with a TPMS malfunction indicator to indicate when the system is not operating properly. The TPMS malfunction indicator is combined with the low tire pressure telltale. When the system detects a malfunction, the telltale will flash for approximately one minute and then remain continuously illuminated. This sequence will continue upon subsequent vehicle start-ups as long as the malfunction exists.

When the malfunction indicator is illuminated, the system may not be able to detect or signal low tire pressure as intended. TPMS malfunctions may occur for a variety of reasons, including the installation of replacement or alternate tires or wheels on the vehicle that prevent the TPMS from functioning properly.

Always check the TPMS malfunction telltale after replacing one or more tires or wheels on your vehicle to ensure that the replacement or alternate tires and wheels allow the TPMS to continue to function properly.

NOTICE

If any of the below happens, have the system checked by an authorized HYUNDAI dealer.

1. The Low Tire Pressure Telltale/TPMS Malfunction Indicator does not illuminate for 3 seconds when the START/STOP button is placed to the ON position or the vehicle is ON (☹ indicator ON).
2. The TPMS Malfunction Indicator remains illuminated after blinking for approximately 1 minute.
3. The Low Tire Pressure Position Telltale remains illuminated.



Low tire pressure telltale

Low tire pressure position and tire pressure telltale



When the tire pressure monitoring system warning indicators are illuminated and warning message displayed on the cluster LCD display, one or more of your tires is significantly under-inflated. The Low Tire Pressure Position Telltale will indicate which tire is significantly under-inflated by illuminating the corresponding position light.

If either telltale illuminates, immediately reduce your speed, avoid hard cornering and anticipate increased stopping distances. You should stop and check your tires as soon as possible. Inflate the tires to the proper pressure as indicated on the vehicle's placard or tire inflation pressure label located on the driver's side center pillar outer panel.

If you cannot reach a service station or if the tire cannot hold the newly added air, replace the low pressure tire with the spare tire.

The Low Tire Pressure Telltale will remain on and the TPMS Malfunction Indicator may blink for one minute and then remain illuminated (when the vehicle is driven approximately 10 minutes at speed above 25 km/h (15.5 mph)) until you have the low pressure tire repaired and replaced on the vehicle.

 **CAUTION**

In winter or cold weather, the Low Tire Pressure Telltale may be illuminated if the tire pressure was adjusted to the recommended tire inflation pressure in warm weather. It does not mean your TPMS is malfunctioning because the decreased temperature leads to a proportional lowering of tire pressure.

When you drive your vehicle from a warm area to a cold area or from a cold area to a warm area, or the outside temperature is greatly higher or lower, you should check the tire inflation pressure and adjust the tires to the recommended tire inflation pressure.

 **WARNING**

Low pressure damage

Significantly low tire pressure makes the vehicle unstable and can contribute to loss of vehicle control and increased braking distances.

Continued driving on low pressure tires can cause the tires to overheat and fail.



TPMS (Tire Pressure Monitoring System) malfunction indicator

The TPMS Malfunction Indicator will illuminate after it blinks for approximately one minute when there is a problem with the Tire Pressure Monitoring System.

We recommend that the system be checked by an authorized HYUNDAI dealer as soon as possible.

NOTICE

If there is a malfunction with the TPMS, the Low Tire Pressure Position Telltale will not be displayed even though the vehicle has an under-inflated tire.

NOTICE

The TPMS Malfunction Indicator may illuminate after blinking for one minute if the vehicle is near electric power supply cables or radio transmitters such as police stations, government and public offices, broadcasting stations, military installations, airports, transmitting towers, etc.

Additionally, the TPMS Malfunction Indicator may illuminate if snow chains are used or electronic devices such as computers, chargers, remote starters, navigation, etc. This may interfere with normal operation of the TPMS.

Changing a tire with TPMS

If you have a flat tire, the Low Tire Pressure and Position telltales will come on. We recommend that the flat tire be repaired by an authorized HYUNDAI dealer as soon as possible or replace the flat tire with the spare tire.



CAUTION

It is recommended that you do not use a puncture-repairing agent not approved by a HYUNDAI dealer to repair and/or inflate a low pressure tire. Tire sealant not approved by a HYUNDAI dealer may damage the tire pressure sensor.

Once the original tire equipped with a tire pressure monitoring sensor is reinflated to the recommended pressure and reinstalled on the vehicle, the Low Tire Pressure Telltale and TPMS Malfunction Indicator will go off within a few minutes of driving.

If the indicators do not extinguish after a few minutes, please visit an authorized HYUNDAI dealer.

Each wheel is equipped with a tire pressure sensor mounted inside the tire behind the valve stem. You must use TPMS specific wheels. It is recommended that you always have your tires serviced by an authorized HYUNDAI dealer.

You may not be able to identify a tire with low pressure by simply looking at it. Always use a good quality tire pressure gauge to measure. Please note that a tire that is hot (from being driven) will have a higher pressure measurement than a tire that is cold.

A cold tire means the vehicle has been sitting for 3 hours and driven for less than 1.6 km (1 mile) in that 3 hour period.

Allow the tire to cool before measuring the inflation pressure. Always be sure the tire is cold before inflating to the recommended pressure.

 **WARNING**

- The TPMS cannot alert you to severe and sudden tire damage caused by external factors such as nails or road debris.
- If you feel any vehicle instability, immediately take your foot off the accelerator, apply the brakes gradually with light force, and slowly move to a safe position off the road.

 **WARNING**

Tampering with, modifying, or disabling the Tire Pressure Monitoring System (TPMS) components may interfere with the system's ability to warn the driver of low tire pressure conditions and/or TPMS malfunctions. Tampering with, modifying, or disabling the Tire Pressure Monitoring System (TPMS) components may void the warranty for that portion of the vehicle.

IF YOU HAVE A FLAT TIRE (WITH SPARE TIRE)

WARNING

Changing a tire can be dangerous. Follow the instructions in this section when changing a tire to reduce the risk of serious injury or death.

CAUTION

Be careful as you use the jack handle to stay clear of the flat end. The flat end has sharp edges that could cause cuts.

Jack and tools

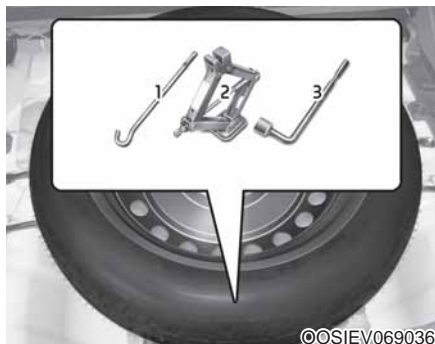

- (1) Jack handle
- (2) Jack
- (3) Wheel nut wrench

The jack, jack handle, and wheel nut wrench are stored in the luggage compartment under the luggage box cover.

The jack is provided for emergency tire changing only.



Turn the winged hold down bolt counterclockwise to remove the spare tire.

Store the spare tire in the same compartment by turning the winged hold down bolt clockwise.

To prevent the spare tire and tools from "rattling", store them in their proper location.



If it is hard to loosen the tire hold-down wing bolt by hand, you can loosen it easily using the wheel nut wrench.

Turn the tire hold-down wing bolt counterclockwise with the wheel nut wrench.

Install and remove the jack



Mount the jack after being fastened the spare tire to the bar when you install the jack.

You should mount the jack following the guide line.

Stop the jack when it touches the bracket.

You should fit the jack in a suitable position to support the load of the tire.

Changing tires

⚠ WARNING

A vehicle can slip or roll off of a jack causing serious injury or death to you or those nearby. Take the following safety precautions:

- Do not get under a vehicle that is supported by a jack.
- **NEVER** attempt to change a tire in the lane of traffic. **ALWAYS** move the vehicle completely off the road on level, firm ground away from traffic before trying to change a tire. If you cannot find a level, firm place off the road, call a towing service for assistance.
- Be sure to use the jack provided with the vehicle.
- **ALWAYS** place the jack on the designated jacking positions on the vehicle and **NEVER** on the bumpers or any other part of the vehicle for jacking support.

- Do not start or run the engine while the vehicle is on the jack.
- Do not allow anyone to remain in the vehicle while it is on the jack.
- Keep children away from the road and the vehicle.

Follow these steps to change your vehicle's tire:

1. Park on a level, firm surface.
2. Move the shift lever into P (Park, for dual clutch transmission vehicle) or neutral (for manual transmission vehicle), apply the parking brake, and place the ignition switch in the LOCK/OFF position.
3. Press the hazard warning flasher button.
4. Remove the wheel lug nut wrench, jack, jack handle, and spare tire from the vehicle.



[A] : Block

5. Block both the front and rear of the tire diagonally opposite of the tire you are changing.



6. Loosen the wheel lug nuts counterclockwise one turn each in the order shown above, but do not remove any lug nuts until the tire has been raised off of the ground.

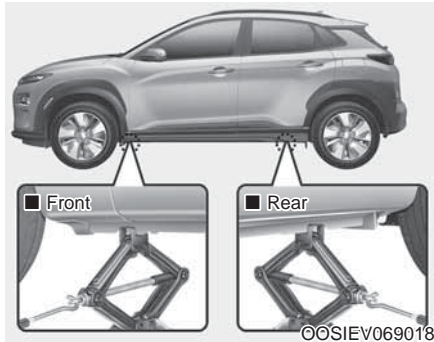

7. Place the jack at the designated jacking position under the frame closest to the tire you are changing. The jacking positions are plates welded to the frame with two notches. Never jack at any other position or part of the vehicle. It may damage the side seal molding.



8. Insert the jack handle into the jack and turn it clockwise, raising the vehicle until the tire clears the ground. Make sure the vehicle is stable on the jack.

9. Loosen the lug nuts with the wheel lug nut wrench and remove them with your fingers. Remove the wheel from the studs and lay it flat on the ground out of the way. Remove any dirt or debris from the studs, mounting surfaces, and wheel.

10. Install the spare tire onto the studs of the hub.

11. Tighten the lug nuts with your fingers onto the studs with the smaller end of the lug nuts closest to the wheel.

12. Lower the vehicle to the ground by turning the jack handle counterclockwise.



13. Use the wheel lug nut wrench to tighten the lug nuts in the order shown. Double-check each lug nut until they are tight. After changing tires, we recommend that an authorized HYUNDAI dealer tighten the lug nuts to their proper torque as soon as possible. **The wheel lug nut should be tightened to 11~13 kgf-m (79~94 lbf-ft).**

If you have a tire gauge, check the tire pressure (see "Tires and Wheels" in chapter 8 for tire pressure instructions.). If the pressure is lower or higher than recommended, drive slowly to the nearest service station and adjust it to the recommended pressure. Always reinstall the valve cap after checking or adjusting tire pressure. If the cap is not replaced, air may leak from the tire. If you lose a valve cap, buy another and install it as soon as possible. After changing tires, put the flat tire in its place and return the jack and tools to their proper storage locations.

NOTICE

- **Check the tire pressure as soon as possible after installing a spare tire. Adjust it to the recommended pressure.**
- **Check and tighten the wheel lug nuts after driving over 50 km if tires are replaced. Re-check the tire wheel lug nuts after driving over 1,000 km.**

CAUTION

Your vehicle has metric threads on the studs and lug nuts. Make certain during tire changing that the same nuts that were removed are reinstalled. If you have to replace your lug nuts make sure they have metric threads to avoid damaging the studs and ensure the wheel is properly secured to the hub. We recommend that you consult an authorized HYUNDAI dealer for assistance.

If any of the equipment such as the jack, lug nuts, studs, or other equipment is damaged or in poor condition, do not attempt to change the tire and call for assistance.

Use of compact spare tires (if equipped)

Compact spare tires are designed for emergency use only. Drive carefully on the compact spare tire and always follow the safety precautions.

WARNING

To prevent compact spare tire failure and loss of control possibly resulting in an accident:

- **Use the compact spare tire only in an emergency.**
- **NEVER operate your vehicle over 80 km/h (50 mph).**
- **Do not exceed the vehicle's maximum load rating or the load carrying capacity shown on the sidewall of the compact spare tire.**
- **Do not use the compact spare tire continuously. Repair or replace the original tire as soon as possible to avoid failure of the compact spare tire.**

When driving with the compact spare tire mounted to your vehicle:

- Check the tire pressure after installing the compact spare tire. The compact spare tire should be inflated to 420 kPa (60 psi).
- Do not take this vehicle through an automatic car wash while the compact spare tire is installed.
- Do not use the compact spare tire on any other vehicle because this tire has been designed especially for your vehicle.
- The compact spare tire's tread life is shorter than a regular tire. Inspect your compact spare tire regularly and replace worn compact spare tires with the same size and design, mounted on the same wheel.
- Do not use more than one compact spare tire at a time.
- Do not tow a trailer while the compact spare tire is installed.

NOTICE

When the original tire and wheel are repaired and reinstalled on the vehicle, the lug nut torque must be set correctly. The correct lug nut tightening torque is 11~13 kgf-m (79~94 lbf-ft).

⚠ CAUTION

To prevent damaging the compact spare tire and your vehicle:

- Drive slowly enough for the road conditions to avoid all hazards, such as a potholes or debris.
- Avoid driving over obstacles. The compact spare tire diameter is smaller than the diameter of a conventional tire and reduces the ground clearance approximately 25 mm (1 inch).
- Do not use tire chains on the compact spare tire. Because of the smaller size, a tire chain will not fit properly.
- Do not use the compact spare tire on any other wheels, nor should standard tires, snow tires, wheel covers or trim rings be used with the compact spare wheel.

Jack label

■ Example

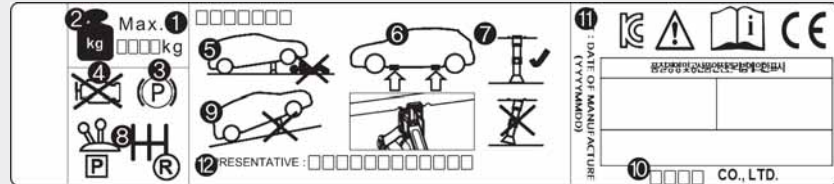

OOS067043

The actual Jack label in the vehicle may differ from the illustration. For more detailed specifications, refer to the label attached to the jack.

1. Model Name
2. Maximum allowable load
3. When using the jack, set your parking brake.
4. When using the jack, stop the engine.
5. Do not get under a vehicle that is supported by a jack.
6. The designated locations under the frame
7. When supporting the vehicle, the base plate of jack must be vertical under the lifting point.
8. Shift into Reverse gear on vehicles with manual transmission or move the shift lever to the P position on vehicles with dual clutch transmission.
9. The jack should be used on firm level ground.
10. Jack manufacture
11. Production date
12. Representative company and address

EC Declaration of conformity for Jack

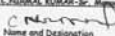
 MK TRON AUTOPARTS PRIVATE LIMITED <small>(Formerly known as LMV Dorgahin Motech Private Limited)</small>		
13.04.2022		
EC DECLARATION OF CONFORMITY According to EC Machinery directive 2006/42/EC Here with declare that the following products is in conformity with the provision of following EC Directive(s) he undersigned representing the manufacturer: Manufacturer Name: M/s. MKTRON AUTO PARTS PRIVATE LIMITED. Address : H 4 133, SIDCO INDUSTRIAL, THIRUMADIASAI, CHENNAI-600 124, TAMIL NADU, INDIA Declare under our sole responsibility that the products : Products : Jack Assemblies - Pantograph & Bottle jacks Type Designation[s] : 700 KG, 800 KG, 1000 KG & 2000 KG Serial no : NA (proto type) Year of manufacture: 2021 In which the declaration recasts it is in conformity with the following standards or other normative documents EN -15012100 Safety of machinery-General principles for design- risk assessment and risk reduction [2010] EN 15012100-2/A1 Safety of machinery -Basic concepts, general principles design part [2009] Part-2 Technical principles EN1494/A1 Mobile or movable jacks and associated lifting equipment [2006] Following the provisions of Directives: 2006/42/EC Directive on the approximation of the laws of member states relating to machinery Directive [OJL157 24. 2006] MKTRON AUTO PARTS PVT.LTD, INDIA /02.09.2021. C.NIRMAL KUMAR-Sc. Manager - Operation Name & Place of  Home and Designation • T.C.F. Compiling Person: GS Karish A6 • E.O. Oper. Nbr: 6335, CCI: 8050, Karish		
STAMPING DIVISION Plot No. A-19, Talegaon Industrial Area, Village Nivkhumbra, Tal. Masal, Pune - 410 507, Maharashtra, INDIA. Tel. No. : +91 2114 308935	JACK DIVISION No. 14, SIDCO Industrial Estate, Thirumadai, Chennai 600124, Tamil Nadu, INDIA Tel. No. : +91-44-26810211	DIE CASTING DIVISION 821 & B, 18C, SIDCO Industrial Estate, Thirumadai, Chennai - 600 132, Tamil Nadu, INDIA. Tel. No. : +91-44-4804 7777
CIN NO.: U29255PN2007PTC133046 Registered Office: Plot No. A-19, Talegaon Industrial Area, Village Nivkhumbra, Tal. Masal, Pune - 410 507, Maharashtra, INDIA.		

NX41082001

TOWING

Towing service

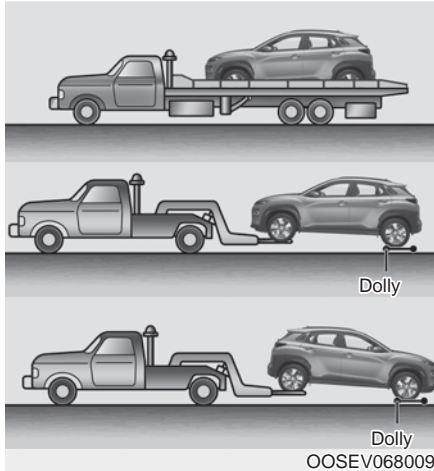

If emergency towing is necessary, we recommend having it done by an authorized HYUNDAI dealer or a commercial tow-truck service.

Proper lifting and towing procedures are necessary to prevent damage to the vehicle. The use of wheel dollies or flatbed is recommended.

It is acceptable to tow the vehicle with the rear wheels on the ground (without dollies) and the front wheels off the ground.

If any of the loaded wheels or suspension components are damaged or the vehicle is being towed with the front wheels on the ground, use a towing dolly under the front wheels.

When being towed by a commercial tow truck and wheel dollies are not used, the front of the vehicle should always be lifted, not the rear.



CAUTION

- Do not tow the vehicle with the front wheels on the ground as this may cause damage to the vehicle.



Precautions when moving a short distance before towing a vehicle

Move short distances within 10 m at a speed of 5 km/h (3 mph) or less only when loading on a tow truck or if the vehicle needs to be repositioned. At this time, the gear must be in the 'N' (neutral) position and the parking brake must be released. If it is impossible to operate the reduction gear and parking brake, move the vehicle with the front wheel lifted.



CAUTION

- Do not tow with sling-type equipment. Use wheel lift or flatbed equipment.



Removable towing hook

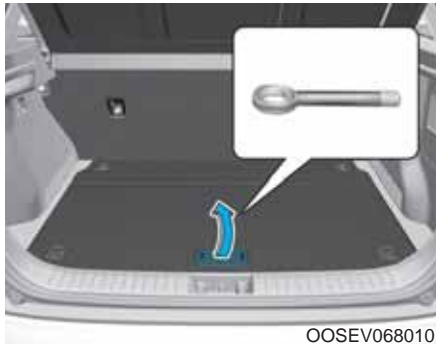

1. Open the tailgate and remove the towing hook from the tool case. The tool case is placed under the luggage tray.

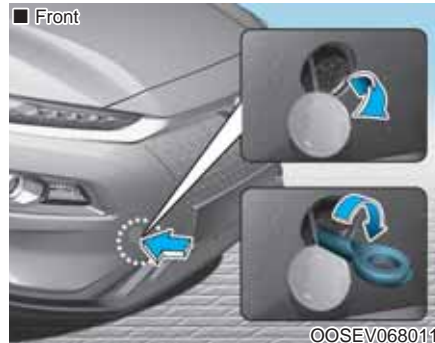

2. Remove the hole cover by pressing the lower part of the cover on the bumper.

3. Install the towing hook by turning it clockwise into the hole until it is fully secured.
4. Remove the towing hook and install the cover after use.

Maintenance

Motor compartment	8-3	Battery (12 Volt)	8-21
Maintenance services	8-4	For best battery service	8-22
Owner's responsibility	8-4	Battery capacity label.....	8-22
Owner maintenance precautions	8-4	Battery recharging	8-23
Owner maintenance	8-5	Reset features.....	8-24
Owner maintenance schedule	8-5	Tires and wheels.....	8-25
Scheduled maintenance services	8-7	Tire care.....	8-25
Normal maintenance schedule - Except Europe	8-8	Recommended cold tire inflation pressures.....	8-26
Maintenance under severe usage conditions -		Check tire inflation pressure.....	8-27
Except Europe	8-10	Tire rotation	8-28
Explanation of scheduled maintenance items	8-12	Wheel alignment and tire balance	8-29
Coolant	8-13	Tire replacement.....	8-29
Brake fluid	8-14	Wheel replacement.....	8-30
Checking the brake fluid level	8-14	Tire traction	8-30
Washer fluid	8-15	Tire maintenance	8-30
Checking the washer fluid level	8-15	Tire sidewall labeling.....	8-30
Climate control air filter	8-16	Fuses	8-35
Filter inspection.....	8-16	Instrument panel fuse replacement	8-36
Wiper blades.....	8-18	Motor compartment panel fuse replacement.....	8-37
Blade inspection.....	8-18	Fuse/relay panel description	8-38
Blade replacement.....	8-18		

Light bulbs	8-50
Headlamp, daytime running light (DRL), position lamp, turn signal lamp and static lamp bulb replacement	8-51
Side repeater lamp replacement	8-56
Rear combination lamp bulb replacement	8-56
High mounted stop lamp bulb replacement	8-59
License plate light bulb replacement	8-59
Interior light bulb replacement	8-60
Appearance care	8-62
Exterior care	8-62
Interior care	8-67

MOTOR COMPARTMENT

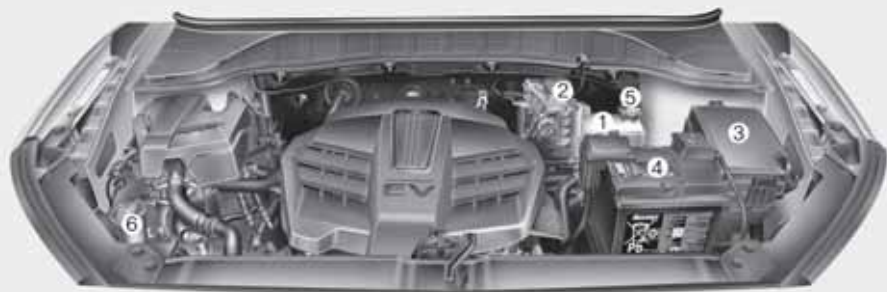

1. Coolant reservoir
2. Brake fluid reservoir
3. Fuse box
4. Battery (12 volt)
5. Coolant reservoir cap
6. Windshield washer fluid reservoir

The actual motor compartment in the vehicle may differ from the illustration.

OOSEV078001

MAINTENANCE SERVICES

You should exercise the utmost care to prevent damage to your vehicle and injury to yourself whenever performing any maintenance or inspection procedures.

We recommend you have your vehicle maintained and repaired by an authorized HYUNDAI dealer. An authorized HYUNDAI dealer meets HYUNDAI's high service quality standards and receives technical support from HYUNDAI in order to provide you with a high level of service satisfaction.

Owner's responsibility

Maintenance service and record retention are the owner's responsibility.

You should retain documents that show proper maintenance has been performed on your vehicle in accordance with the scheduled maintenance service charts shown on the following pages. You need this information to establish your compliance with the servicing and maintenance requirements of your vehicle warranties.

Detailed warranty information is provided in your Service Passport.

Repairs and adjustments required as a result of improper maintenance or a lack of required maintenance are not covered.

Owner maintenance precautions

Inadequate, incomplete or insufficient servicing may result in operational problems with your vehicle that could lead to vehicle damage, an accident, or personal injury. This chapter provides instructions only for the maintenance items that are easy to perform. Several procedures can be done only by an authorized HYUNDAI dealer with special tools.

Your vehicle should not be modified in any way. Such modifications may adversely affect the performance, safety or durability of your vehicle and may, in addition, violate conditions of the limited warranties covering the vehicle.

NOTICE

Improper owner maintenance during the warranty period may affect warranty coverage. For details, read the separate Service Passport provided with the vehicle. If you're unsure about any service or maintenance procedure, have it done by an authorized HYUNDAI dealer.

OWNER MAINTENANCE

WARNING

Performing maintenance work on a vehicle can be dangerous. If you lack sufficient knowledge and experience or the proper tools and equipment to do the work, have it done by an authorized HYUNDAI dealer. ALWAYS follow these precautions for performing maintenance work:

- Park your vehicle on level ground, shift to P (Park) position, apply the parking brake, place the START/STOP button in the OFF position.
- Block the tires (front and back) to prevent the vehicle from moving.

Remove loose clothing or jewelry that can become entangled in moving parts.

- Keep flames, sparks, or smoking materials away from the battery related parts.

The following lists are vehicle checks and inspections that should be performed by the owner or an authorized HYUNDAI dealer at the frequencies indicated to help ensure safe, dependable operation of your vehicle.

Any adverse conditions should be brought to the attention of your dealer as soon as possible.

These Owner Maintenance vehicle checks are generally not covered by warranties and you may be charged for labor, parts and lubricants used.

Owner maintenance schedule

When you stop for charging:

- Check coolant level in the coolant reservoir.
- Check the windshield washer fluid level.
- Check for low or under-inflated tires.

WARNING

Be careful when checking your coolant level if the parts in the motor compartment are hot. This may result in coolant being blown out of the opening and cause serious burns and other injuries.

While operating your vehicle:

- Check for vibrations in the steering wheel. Notice if there is any increased steering effort or looseness in the steering wheel, or change in its straight-ahead position.
- Notice if your vehicle constantly turns slightly or “pulls” to one side when traveling on smooth, level road.
- When stopping, listen and check for unusual sounds, pulling to one side, increased brake pedal travel or “hard-to-push” brake pedal.
- If any slipping or changes in the operation of your reduction gear occurs, check the reduction gear fluid level.
- Check the reduction gear P (Park) function.
- Check the parking brake.
- Check for fluid leaks under your vehicle (water dripping from the air conditioning system during or after use is normal).

At least monthly:

- Check coolant level in the coolant reservoir.
- Check the operation of all exterior lights, including the stoplights, turn signals and hazard warning flashers.
- Check the inflation pressures of all tires including the spare for tires that are worn, show uneven wear, or are damaged.
- Check for loose wheel lug nuts.

At least twice a year: (for example, every Spring and Fall)

- Check radiator, heater and air conditioning hoses for leaks or damage.
- Check windshield washer spray and wiper operation. Clean wiper blades with clean cloth dampened with washer fluid.
- Check headlamp alignment.
- Check the seat belts for wear and function.

At least once a year:

- Clean body and door drain holes.
- Lubricate door hinges and hood hinges.
- Lubricate door and hood locks and latches.
- Lubricate door rubber weather strips.
- Check the air conditioning system.
- Inspect and lubricate reduction gear linkage and controls.
- Clean the battery and terminals.
- Check the brake fluid level.

SCHEDULED MAINTENANCE SERVICES

Follow Normal Maintenance Schedule if the vehicle is usually operated where none of the following conditions apply. If any of the following conditions apply, you must follow the Maintenance Under Severe Usage Conditions.

- Repeatedly driving short distance of less than 8 km (5 miles) in normal temperature or less than 16 km (10 miles) in freezing temperature
- Low speed driving for long distances
- Driving on rough, dusty, muddy, unpaved, graveled or salt spread roads
- Driving in areas using salt or other corrosive materials or in very cold weather
- Driving in heavy dust condition
- Driving in heavy traffic area
- Driving on uphill, downhill, or mountain roads repeatedly
- Towing a trailer, or using a camper or roof rack
- Driving as a patrol car, taxi, other commercial use or vehicle towing
- Driving over 170 km/h (106 miles/h)
- Frequently driving under high speed or rapid acceleration/deceleration
- Frequently driving in stop-and-go conditions

If your vehicle is operated under the above conditions, you should inspect, replace or refill more frequently than the following Normal Maintenance Schedule. After the periods or distance shown in the chart, continue to follow the prescribed maintenance intervals.

Normal maintenance schedule

The following maintenance services must be performed to ensure good vehicle performance.

Keep receipts for all vehicle services to protect your warranty. Where both mileage and time are shown, the frequency of service is determined by whichever occurs first.

MAINTENANCE INTERVALS		Number of months or driving distance, whichever comes first								
		Months	2	12	24	36	48	60	72	84
MAINTENANCE ITEM	Years	-	1	2	3	4	5	6	7	8
	Km×1,000	1.5	10	20	30	40	50	60	70	80
Cooling system		Inspect "Coolant level and leak" every day At first, inspect 60,000 km or 48 months after that, inspect every 30,000 km or 24 months								
Coolant *1		Replace every 60,000 km or 36 months *2								
Reduction gear fluid		-	-	-	-	I	-	-	-	I
Battery condition		-	I	I	I	I	I	I	I	I
All electrical system		-	I	I	I	I	I	I	I	I
Brake lines, hoses and connections		-	I	I	I	I	I	I	I	I
Brake pedal		-	-	I	-	I	-	I	-	I
Parking brake		-	-	I	-	I	-	I	-	I

I : Inspect and if necessary, adjust, correct, clean or replace.

R : Replace or change.

*1 : When replacing or adding coolant, we recommend that you visit an authorized HYUNDAI dealer.

*2 : For your convenience, it can be replaced prior to it's interval when you do maintenance of other items.

Normal maintenance schedule

MAINTENANCE INTERVALS MAINTENANCE ITEM	Number of months or driving distance, whichever comes first									
	Months	2	12	24	36	48	60	72	84	96
	Years	-	1	2	3	4	5	6	7	8
	Km×1,000	1.5	10	20	30	40	50	60	70	80
Brake fluid*										
Brake discs and pads										
Steering gear rack, linkage and boots										
Driveshaft and boots	-	-	-	-		-	-	-	-	
Tire (pressure, condition & rotation)*	-									
Front suspension ball joints	-									
Bolt and nuts on chassis and body	-									
Air conditioner refrigerant	-	-		-		-		-		
Air conditioner compressor	-	-		-		-		-		
Climate control air filter*										
Wheel Alignment & Balancing*										
Warning lights & operation GDS system check										
TPMS Sensor ID writing*										

I : Inspect and if necessary, adjust, correct, clean or replace

TR: Tyre rotation

R : Replace or change

T : Teaching

* : Chargeable basis

Maintenance under severe usage conditions

The following items must be serviced more frequently on cars mainly used under severe driving conditions. Refer to the chart below for the appropriate maintenance intervals.

R : Replace I : Inspect and if necessary, adjust, correct, clean or replace

Maintenance item	Maintenance operation	Maintenance intervals	Driving condition
Reduction gear fluid	R	Every 1,20,000 km (80,000 miles)	C, D, E, F, G, H, I, J
Steering gear rack, linkage and boots	I	Inspect more frequently depending on the condition	C, D, E, F, G
Front suspension ball joints	I	Inspect more frequently depending on the condition	C, D, E, F, G
Disc brakes and pads, calipers and rotors	I	Inspect more frequently depending on the condition	C, D, E, G, H

Maintenance under severe usage conditions

Maintenance item	Maintenance operation	Maintenance intervals	Driving condition
Driveshaft and boots	I	Inspect more frequently depending on the condition	C, D, E, F, G, H, I
Climate control air filter	R	Replace more frequently depending on the condition	C, E

Severe driving conditions

- A : Repeatedly driving short distance of less than 8 km (5 miles) in normal temperature or less than 16 km (10 miles) in freezing temperature
- B : Low speed driving for long distances
- C : Driving on rough, dusty, muddy, unpaved, graveled or salt spread roads
- D : Driving in areas using salt or other corrosive materials or in very cold weather
- E : Driving in heavy dust condition
- F : Driving in heavy traffic area

- G : Driving on uphill, downhill, or mountain roads repeatedly
- H : Towing a trailer, or using a camper or roof rack
- I : Driving as a patrol car, taxi, other commercial use or vehicle towing
- J : Driving over 170 Km/h (106 miles/h)
- K : Frequently driving in stop-and-go conditions

EXPLANATION OF SCHEDULED MAINTENANCE ITEMS

Cooling system

Check cooling system components, such as radiator, coolant reservoir, hoses and connections for leakage and damage. Replace any damaged parts.

Coolant

The coolant should be changed at the intervals specified in the maintenance schedule.

Reduction gear fluid

The reduction gear fluid should be inspected according to the intervals specified in the maintenance schedule.

Brake hoses and lines

Visually check for proper installation, chafing, cracks, deterioration and any leakage. Replace any deteriorated or damaged parts immediately.

Brake fluid

Check brake fluid level in the brake fluid reservoir. The level should be between the MIN and the MAX marks on the side of the reservoir. Use only hydraulic brake fluid conforming to DOT 3 or DOT 4 specification.

Brake discs, pads, calipers and rotors

Check the pads, the disc, and the rotor for any excessive wear-out. Inspect calipers for any fluid leakage. For more information on checking the pads or lining wear limit, refer to the HYUNDAI web site.

(<http://service.hyundai-motor.com>)

Suspension mounting bolts

Check the suspension connections for looseness or damage. Retighten to the specified torque.

Steering gear box, linkage & boots/lower arm ball joint

With the vehicle stopped and the hybrid system off, check for excessive free-play in the steering wheel. Check the linkage for bends or damage. Check the dust boots and ball joints for deterioration, cracks, or damage.

Replace any damaged parts.

Drive shafts and boots

Check the drive shafts, boots and clamps for cracks, deterioration, or damage. Replace any damaged parts and, if necessary, repack the grease.

Air conditioning refrigerant

Check the air conditioning lines and connections for leakage and damage.

COOLANT



Check the condition and connections of all cooling system hoses and heater hoses. Replace any swollen or deteriorated hoses.

The coolant level should be filled between the MAX and the MIN marks on the side of the coolant reservoir when the parts in the motor compartment is cool.

If the coolant level is low, have your vehicle inspected by an authorized HYUNDAI dealer. Use only designated coolant water for electric vehicles, adding other types of water or antifreeze can damage the vehicle.

WARNING

Since specific coolant water is applied for electric vehicles, replenishment of other anti-freeze or water may cause problems to the vehicle.

WARNING



The electric motor for the cooling fan may continue to operate or start up when the vehicle is not operating and can cause serious injury.

Keep hands, clothing and tools away from the rotating fan blades of the cooling fan.

The electric motor for the cooling fan is controlled by coolant temperature, refrigerant pressure and vehicle speed. As the coolant temperature decreases, the electric motor will automatically shut off. This is a normal condition.

BRAKE FLUID

Checking the brake fluid level



Check the fluid level in the reservoir periodically. The fluid level should be between MAX and MIN marks on the side of the reservoir.

Before removing the reservoir cap and adding brake fluid, clean the area around the reservoir cap thoroughly to prevent brake fluid contamination.

If the level is low, add the specified brake fluid to the MAX level. The level will fall with accumulated mileage. This is a normal condition associated with the wear of the brake linings. If the fluid level is excessively low, we recommend that the brake system be checked by an authorized HYUNDAI dealer.

i Information

- Use only the specified brake fluid. Refer to “Recommended lubricants and capacities” in chapter 8.
- Before removing the brake filler cap, read the warning on the cap.
- Clean the filler cap before removing. Use only DOT3 or DOT4 brake fluid from a sealed container.

⚠ WARNING

If the brake system requires frequent additions of fluid this could indicate a leak in the brake system. We recommend that the vehicle be inspected by an authorized HYUNDAI dealer.

⚠ WARNING

Do not let brake fluid enter into your eyes. If brake fluid gets in your eyes, flush your eyes with clean water for at least 15 minutes and get immediate medical attention.

NOTICE

- Do not allow brake fluid to contact the vehicle's body paint, as it will result in paint damage.
- NEVER use brake fluid which has been exposed to open air for an extended time, as its quality cannot be guaranteed. It should be disposed of properly.
- Do not use the wrong type of brake fluid. A few drops of mineral based oil in your brake system can damage brake system parts.

WASHER FLUID

Checking the washer fluid level



Check the fluid level in the washer fluid reservoir and add fluid if necessary. Plain water may be used if washer fluid is not available. However, use washer solvent with antifreeze characteristics in cold climates to prevent freezing.

⚠ WARNING

To prevent serious injury or death, take the following safety precautions when using washer fluid:

- Do not use coolant or anti-freeze in the washer fluid reservoir. Coolant can severely obscure visibility when sprayed on the windshield and may cause loss of vehicle control resulting in an accident or damage to paint and body trim.
- Do not allow sparks or flame to contact the washer fluid or the washer fluid reservoir. Washer fluid may contain alcohol and can be flammable.
- Do not drink washer fluid and avoid contact with skin. Washer fluid is poisonous to humans and animals.
- Keep washer fluid away from children and animals.

CLIMATE CONTROL AIR FILTER

Filter inspection

The climate control air filter should be replaced according to the Maintenance Schedule. If the vehicle is operated in severely air-polluted cities or on dusty rough roads for a long period, it should be inspected more frequently and replaced earlier. When you replace the climate control air filter, replace it performing the following procedure, and be careful to avoid damaging other components.



1. With the glove box open, remove the stoppers on both sides.



2. Remove the support rod (1).

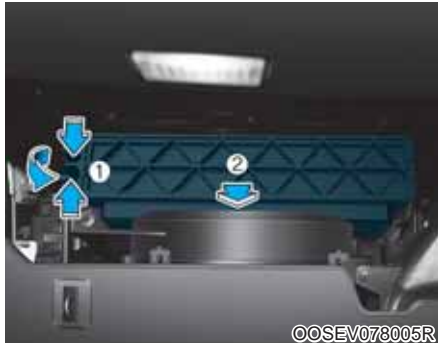

3. Press and hold the lock (1) on the right side of the cover.
4. Pull out (2) the cover.

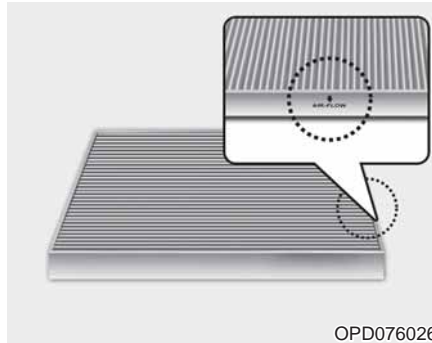

5. Replace the climate control air filter.
6. Reassemble in the reverse order of disassembly.

NOTICE

Install a new climate control air filter in the correct direction with the arrow symbol (↓) facing downwards. Otherwise, the climate control effects may decrease, possibly with a noise.

WIPER BLADES

Blade inspection

Contamination of either the windshield or the wiper blades with foreign matter can reduce the effectiveness of the windshield wipers.

Common sources of contamination are insects, tree sap, and hot wax treatments used by some commercial car washes. If the blades are not wiping properly, clean both the window and the blades with a good cleaner or mild detergent, and rinse thoroughly with clean water.

NOTICE

To prevent damage to the wiper blades, arms or other components, do not:

- Use gasoline, kerosene, paint thinner, or other solvents on or near them.
- Attempt to move the wipers manually.
- Use non-specified wiper blades.

i Information

Commercial hot waxes applied by automatic car washes have been known to make the windshield difficult to clean.

i Information

Wiper blades are a consumable item and normal wear of the wipers may not be covered by your vehicle warranty.

Blade replacement

When the wipers no longer clean adequately, the blades may be worn or cracked, and require replacement.

NOTICE

- In order to prevent damage to the hood and the wiper arms, the wiper arms should only be lifted when in the top wiping position.
- Always return the wiper arms to the windshield before driving.

Front windshield wiper blade

Type A

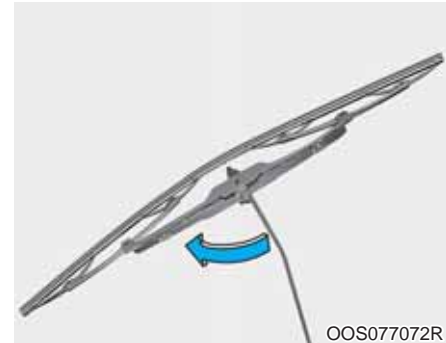

1. Raise the wiper arm and turn the wiper blade assembly to expose the plastic locking clip.

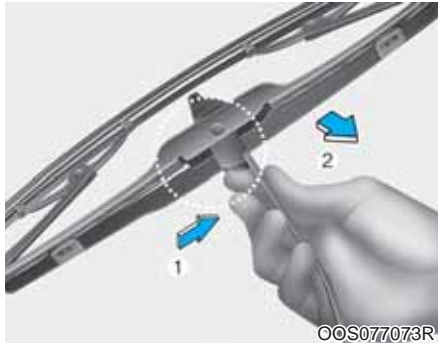

OOS077073R

2. Press the clip (1) and slide the blade assembly downward (2).

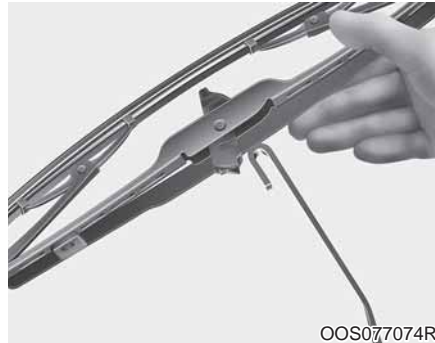

OOS077074R

3. Lift it off the arm.

4. Install a new wiper blade assembly in the reverse order of removal.

5. Return the wiper arm on the windshield.

Type B



OJS078073AU

1. Raise the wiper arm.

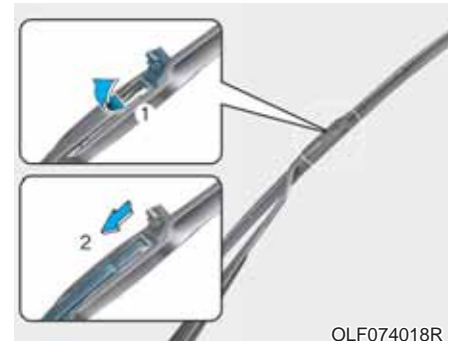

OLF074018R

2. Lift up the wiper blade clip (1). Then pull down the blade assembly and remove it (2).



3. Install the new blade assembly in the reverse order of removal.
4. Return the wiper arm on the windshield.

Rear window wiper blade



1. Raise the wiper arm and then turn the wiper blade assembly (1).
2. Pull out the wiper blade assembly (2).



3. Install the new blade assembly by inserting the center part into the slot in the wiper arm until it clicks into place (3).
4. Make sure the blade assembly is installed firmly by trying to pull it slightly.

To prevent damage to the wiper arms or other components, we recommend that the wiper blades be replaced by an authorized HYUNDAI dealer.

BATTERY (12 VOLT)

WARNING

To prevent **SERIOUS INJURY** or **DEATH** to you or bystanders, always follow these precautions when working near or handling the battery:



Always read and follow instructions carefully when handling a battery.



Wear eye protection designed to protect the eyes from acid splashes.



Keep all flames, sparks, or smoking materials away from the battery.



Hydrogen is always present in battery cells, is highly combustible, and may explode if ignited.



Keep batteries out of reach of children.



Batteries contain sulfuric acid which is highly corrosive. Do not allow acid to contact your eyes, skin or clothing.

If acid gets into your eyes, flush your eyes with clean water for at least 15 minutes and get immediate medical attention. If acid gets on your skin, thoroughly wash the area. If you feel pain or a burning sensation, get medical attention immediately.

- When lifting a plastic-cased battery, excessive pressure on the case may cause battery acid to leak. Lift with a battery carrier or with your hands on opposite corners.
- Do not attempt to jump start your vehicle if your battery is frozen.

- **NEVER** attempt to recharge the battery when the vehicle's battery cables are connected to the battery.
- The electrical ignition switch works with high voltage. **NEVER** touch these components with the “” indicator ON or when the START/STOP button is in the ON position.

NOTICE

Always follow these instructions when handling your vehicle's battery to prevent damage to your battery:

- When you do not use the vehicle for a long time in a low temperature area, disconnect the battery and keep it indoors.
- Always charge the battery fully to prevent battery case damage in low temperature areas.
- Prevent liquid from wetting the battery terminals. The performance of the battery may be degraded, and may cause injury. Be cautious when loading liquid in the trunk.
- Do not tilt the battery.
- If you connect unauthorized electronic devices to the battery, the battery may be discharged. Never use unauthorized devices.

For best battery service



- Keep the battery securely mounted.
- Keep the battery top clean and dry.
- Keep the terminals and connections clean, tight, and coated with petroleum jelly or terminal grease.
- Rinse any spilled acid from the battery immediately with a solution of water and baking soda.

Battery capacity label

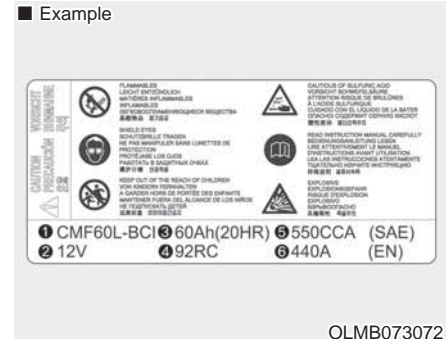

* The actual battery label in the vehicle may differ from the illustration.

1. AGM60L-DIN : The HYUNDAI model name of battery
2. 12V : The nominal voltage
3. 60Ah(20HR) : The nominal capacity (in Ampere hours)
4. 100RC : The nominal reserve capacity (in min.)
5. 640CCA : The cold-test current in amperes by SAE
6. 512A : The cold-test current in amperes by EN

Battery recharging

By battery charger

Your vehicle has a maintenance-free, calcium-based battery.

- If the battery becomes discharged in a short time (because, for example, the headlights or interior lights were left on while the vehicle was not in use), recharge it by slow charging (trickle) for 10 hours.
- If the battery gradually discharges because of high electric load while the vehicle is being used, recharge it at 20-30A for two hours.

WARNING

Always follow these instructions when recharging your vehicle's battery to avoid the risk of **SERIOUS INJURY or **DEATH** from explosions or acid burns:**

- **Before performing maintenance or recharging the battery, turn off all accessories and place the START/STOP button to the OFF position.**
- **Keep all flames, sparks, or smoking materials away from the battery.**
- **Always work outdoors or in an area with plenty of ventilation.**
- **Wear eye protection when checking the battery during charging.**
- **The battery must be removed from the vehicle and placed in a well ventilated area.**

- **Watch the battery during charging, and stop or reduce the charging rate if the battery cells begin boiling violently.**
- **The negative battery cable must be removed first and installed last when the battery is disconnected. Disconnect the battery charger in the following order:**
 - (1) **Turn off the battery charger main switch.**
 - (2) **Unhook the negative clamp from the negative battery terminal.**
 - (3) **Unhook the positive clamp from the positive battery terminal.**
- **Always use a genuine HYUNDAI approved battery when you replace the battery.**

By jump starting

After a jump start from a good battery, drive the vehicle for 20-30 minutes before it is shutoff. The vehicle may not restart if you shut it off before the battery had a chance to adequately recharge. See “Jump Starting” in chapter 6 for more information on jump starting procedures.

***i* Information**



An inappropriately disposed battery can be harmful to the environment and human health. Dispose of the battery according to your local law(s) or regulation.

Reset features

Some items need to be reset after the battery has been discharged or the battery has been disconnected.

- Power Windows
- Trip Computer
- Climate Control System
- Clock
- Audio System
- Sunroof

TIRES AND WHEELS

WARNING

Tire failure may cause loss of vehicle control resulting in an accident. To reduce risk of **SERIOUS INJURY** or **DEATH**, take the following precautions:

- Inspect your tires monthly for proper inflation as well as wear and damage.
- The recommended cold tire pressure for your vehicle can be found in this manual and on the tire label located on the driver's side center pillar. Always use a tire pressure gauge to measure tire pressure. Tires with too much or too little pressure wear unevenly causing poor handling.
- Check the pressure of the spare every time you check the pressure of the other tires on your vehicle.

- Replace tires that are worn, show uneven wear, or are damaged. Worn tires can cause loss of braking effectiveness, steering) control, or traction.
- **ALWAYS** replace tires with the same size as each tire that was originally supplied with this vehicle. Using tires and wheels other than the recommended sizes could cause unusual handling characteristics, poor vehicle control, or negatively affect your vehicle's Anti-Lock Brake System (ABS) resulting in a serious accident.

Tire care

For proper maintenance, safety, and maximum fuel economy, you must always maintain recommended tire inflation pressures and stay within the load limits and weight distribution recommended for your vehicle.

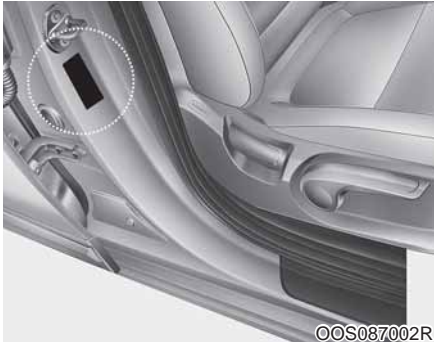

All specifications (sizes and pressures) can be found on a label attached to the driver's side center pillar.

Recommended cold tire inflation pressures

All tire pressures (including the spare) should be checked when the tires are cold. "Cold tires" means the vehicle has not been driven for at least three hours or driven less than 1.6 km (one mile).

Warm tires normally exceed recommended cold tire pressures by 28 to 41 kPa (4 to 6 psi). Do not release air from warm tires to adjust the pressure or the tires will be under-inflated. For recommended inflation pressure, refer to "Tire and Wheels" in chapter 8.

WARNING

Recommended pressures must be maintained for the best ride, vehicle handling, and minimum tire wear.

Over-inflation or under-inflation can reduce tire life, adversely affect vehicle handling, and lead to sudden tire failure that could result in loss of vehicle control resulting in an accident.

Severe under-inflation can lead to severe heat build-up, causing blowouts, tread separation and other tire failures that can result in the loss of vehicle control resulting in an accident. This risk is much higher on hot days and when driving for long periods at high speeds.

 **CAUTION**

- **Under-inflation results in excessive wear, poor handling and reduced fuel economy. Wheel deformation is also possible. Keep your tire pressures at the proper levels. If a tire frequently needs refilling, we recommend it be checked by an authorized HYUNDAI dealer.**
- **Over-inflation produces a harsh ride, excessive wear at the center of the tire tread, and a greater possibility of damage from road hazards.**

Check tire inflation pressure

Check your tires, including the spare tire, once a month or more.

How to check

Use a good quality tire pressure gauge to check tire pressure. You can not tell if your tires are properly inflated simply by looking at them. Radial tires may look properly inflated when they are under-inflated.

Remove the valve cap from the tire valve stem. Press the tire gauge firmly onto the valve to get a pressure measurement. If the cold tire inflation pressure matches the recommended pressure on the tire and loading information label, no further adjustment is necessary. If the pressure is low, add air until you reach the recommended pressure. Make sure to put the valve caps back on the valve stems. Without the valve cap, dirt or moisture could get into the valve core and cause air leakage. If a valve cap is missing, install a new one as soon as possible.

If you overfill the tire, release air by pushing on the metal stem in the center of the tire valve. Recheck the tire pressure with the tire gauge. Be sure to put the valve caps back on the valve stems. Without the valve cap, dirt or moisture could get into the valve core and cause air leakage. If a valve cap is missing, install a new one as soon as possible.

Tire rotation

To equalize tread wear, HYUNDAI recommends that the tires be rotated every 10,000 km (6,000 miles) or sooner if irregular wear develops.

During rotation, check the tires for correct balance.

When rotating tires, check for uneven wear and damage. Abnormal wear is usually caused by incorrect tire pressure, improper wheel alignment, out-of-balance wheels, severe braking or severe cornering. Look for bumps or bulges in the tread or side of tire. Replace the tire if you find either of these conditions. Replace the tire if fabric or cord is visible. After rotation, be sure to bring the front and rear tire pressures to specification and check lug nut tightness (proper torque is 11~13 kgf·m [79~94 lbf·ft]).

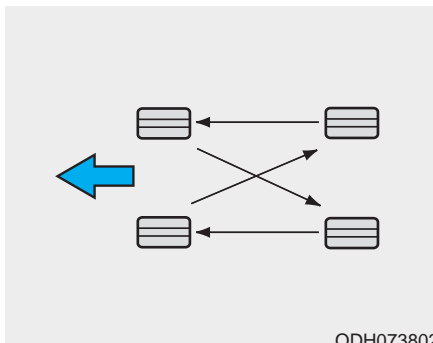

Disc brake pads should be inspected for wear whenever tires are rotated.

i Information

The outside and inside of the unsymmetrical tire is distinguishable. When installing an unsymmetrical tire, be sure to install the side marked "outside" face the outside. If the side marked "inside" is installed on the outside, it will have a bad effect on vehicle performance.

⚠ WARNING

- Do not use the compact spare tire for tire rotation.
- Do not mix bias ply and radial ply tires under any circumstances. This may cause unusual handling characteristics that may cause loss of vehicle control resulting in an accident.

Wheel alignment and tire balance

The wheels on your vehicle were aligned and balanced carefully at the factory to give you the longest tire life and best overall performance.

In most cases, you will not need to have your wheels aligned again. However, if you notice unusual tire wear or your vehicle pulling one way or the other, the alignment may need to be reset.

If you notice your vehicle vibrating when driving on a smooth road, your wheels may need to be rebalanced.

NOTICE

Improper wheel weights can damage your vehicle's aluminum wheels. Use only approved wheel weights.

Tire replacement



If the tire is worn evenly, a tread wear indicator will appear as a solid band across the tread. This shows there is less than 1.6 mm (1/16 in.) of tread left on the tire. Replace the tire when this happens.

Do not wait for the band to appear across the entire tread before replacing the tire.

⚠ WARNING

To reduce the risk of DEATH or SERIOUS INJURY:

- Replace tires that are worn, show uneven wear, or are damaged. Worn tires can cause loss of braking effectiveness, steering control, and traction.
- Always replace tires with the same size as each tire that was originally supplied with this vehicle. Using tires and wheels other than the recommended sizes could cause unusual handling characteristics, poor vehicle control, or negatively affect your vehicle's Anti-Lock Brake System (ABS) resulting in a serious accident.

- **When replacing tires (or wheels), it is recommended to replace the two front or two rear tires (or wheels) as a pair. Replacing just one tire can seriously affect your vehicle's handling.**
- **Tires degrade over time, even when they are not being used. Regardless of the remaining tread, HYUNDAI recommends that tires be replaced after six (6) years of normal service.**
- **Heat caused by hot climates or frequent high loading conditions can accelerate the aging process. Failure to follow this warning may cause sudden tire failure, which could lead to a loss of vehicle control resulting in an accident.**

Wheel replacement

When replacing the metal wheels for any reason, make sure the new wheels are equivalent to the original factory units in diameter, rim width and offset.

Tire traction

Tire traction can be reduced if you drive on worn tires, tires that are improperly inflated or on slippery road surfaces. Tires should be replaced when tread wear indicators appear. To reduce the possibility of losing control, slow down whenever there is rain, snow or ice on the road.

Tire maintenance

In addition to proper inflation, correct wheel alignment helps to decrease tire wear. If you find a tire is worn unevenly, have your dealer check the wheel alignment.

When you have new tires installed, make sure they are balanced. This will increase vehicle ride comfort and tire life. Additionally, a tire should always be rebalanced if it is removed from the wheel.

Tire sidewall labeling

This information identifies and describes the fundamental characteristics of the tire and also provides the tire identification number (TIN) for safety standard certification. The TIN can be used to identify the tire in case of a recall.

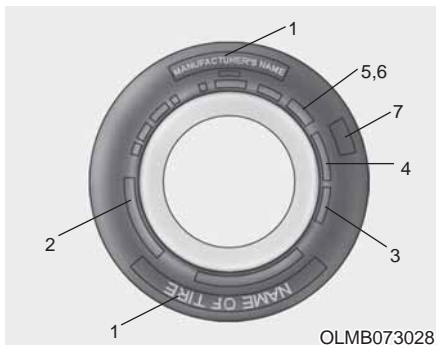

OLMB073028

1. **Manufacturer or brand name**

Manufacturer or brand name is shown.

2. **Tire size designation**

A tire's sidewall is marked with a tire size designation. You will need this information when selecting replacement tires for your car. The following explains what the letters and numbers in the tire size designation mean.

Example tire size designation:

(These numbers are provided as an example only; your tire size designator could vary depending on your vehicle.)

215/55 R17 94V

215 - Tire width in millimeters.

55 - Aspect ratio. The tire's section height as a percentage of its width.

R - Tire construction code (Radial).

17 - Rim diameter in inches.

94 - Load Index, a numerical code associated with the maximum load the tire can carry.

V - Speed Rating Symbol. See the speed rating chart in this section for additional information.

Wheel size designation

Wheels are also marked with important information that you need if you ever have to replace one. The following explains what the letters and numbers in the wheel size designation mean.

Example wheel size designation:

7.0J x 17

7.0 - Rim width in inches.

J - Rim contour designation.

17 - Rim diameter in inches.

Tire speed ratings

The chart below lists many of the different speed ratings currently being used for passenger car tires. The speed rating is part of the tire size designation on the sidewall of the tire. This symbol corresponds to that tire's designed maximum safe operating speed.

Speed Rating Symbol	Maximum Speed
S	180 km/h (112 mph)
T	190 km/h (118 mph)
H	210 km/h (130 mph)
V	240 km/h (149 mph)
Z	Above 240 km/h (149 mph)

3. Checking tire life (TIN : Tire Identification Number)

Any tires that are over six years old, based on the manufacturing date, (including the spare tire) should be replaced by new ones. You can find the manufacturing date on the tire sidewall (possibly on the inside of the wheel), displaying the DOT Code. The DOT Code is a series of numbers on a tire consisting of numbers and English letters. The manufacturing date is designated by the last four digits (characters) of the DOT code.

DOT : XXXX XXXX OOOO

The front part of the DOT means a plant code number, tire size and tread pattern and the last four numbers indicate week and year manufactured.

For example:

DOT XXXX XXXX 1523 represents that the tire was produced in the 15th week of 2023.

4. Tire ply composition and material

The number of layers or plies of rubber-coated fabric in the tire. Tire manufacturers also must indicate the materials in the tire, which include steel, nylon, polyester, and others. The letter "R" means radial ply construction; the letter "D" means diagonal or bias ply construction; and the letter "B" means belted-bias ply construction.

5. Maximum permissible inflation pressure

This number is the greatest amount of air pressure that should be put in the tire. Do not exceed the maximum permissible inflation pressure. Refer to the Tire and Loading Information label for recommended inflation pressure.

6. Maximum load rating

This number indicates the maximum load in kilograms and pounds that can be carried by the tire. When replacing the tires on the vehicle, always use a tire that has the same load rating as the factory installed tire.

7. Uniform tire quality grading

Quality grades can be found where applicable on the tire sidewall between tread shoulder and maximum section width.

For example:

TREADWEAR 200

TRACTION AA

TEMPERATURE A

Tread wear

The tread wear grade is a comparative rating based on the wear rate of the tire when tested under controlled conditions on a specified government test course. For example, a tire graded 150 would wear one-and-a-half times ($1\frac{1}{2}$) as well on the government course as a tire graded 100.

The relative performance of tires depends upon the actual conditions of their use, however, and may depart significantly from the norm due to variations in driving habits, service practices and differences in road characteristics and climate.

These grades are molded on the sidewalls of passenger vehicle tires. The tires available as standard or optional equipment on your vehicle may vary with respect to grade.

Traction - AA, A, B & C

The traction grades, from highest to lowest, are AA, A, B and C. Those grades represent the tire's ability to stop on wet pavement as measured under controlled conditions on specified government test surfaces of asphalt and concrete. A tire marked C may have poor traction performance.

WARNING

The traction grade assigned to this tire is based on straight-ahead braking traction tests, and does not include acceleration, cornering, hydroplaning, or peak traction characteristics.

Temperature - A, B & C

The temperature grades are A (the highest), B and C representing the tire's resistance to the generation of heat and its ability to dissipate heat when tested under controlled conditions on a specified indoor laboratory test wheel.

Sustained high temperature can cause the material of the tire to degenerate and reduce tire life, and excessive temperature can lead to sudden tire failure. Grades B and A represent higher levels of performance on the laboratory test wheel than the minimum required by law.

WARNING

The temperature grade for this tire is established for a tire that is properly inflated and not overloaded. Excessive speed, under-inflation, over-inflation, or excessive loading, either separately or in combination, can cause heat build-up and possible sudden tire failure. This may cause loss of vehicle control resulting in an accident.

FUSES

■ Blade type



Normal



Blown

■ Cartridge type



Normal



Blown

■ Multi fuse

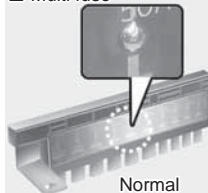

Normal

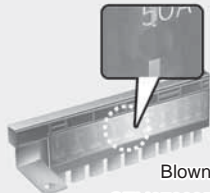

Blown

OTM078035

If any of your vehicle's lights, accessories, or controls do not work, check the appropriate circuit fuse. If a fuse has blown, the element inside the fuse will be melted or broken.

If the electrical system does not work, first check the driver's side fuse panel. Before replacing a blown fuse, turn the vehicle and all switches off, and then disconnect the negative battery cable. Always replace a blown fuse with one of the same rating.

If the replacement fuse blows, this indicates an electrical problem. Avoid using the system involved and immediately consult an authorized HYUNDAI dealer.

A vehicle's electrical system is protected from electrical overload damage by fuses.

This vehicle has 2 (or 3) fuse panels, one located in the driver's side panel bolster, the other in the motor compartment.

i Information

Three kinds of fuses are used: blade type for lower amperage rating, cartridge type, and multi fuse for higher amperage ratings.

! WARNING

NEVER replace a fuse with anything but another fuse of the same rating.

- A higher capacity fuse could cause damage and possibly cause a fire.
- Do not install a wire or aluminum foil instead of the proper fuse - even as a temporary repair. It may cause extensive wiring damage and possibly a fire.

! CAUTION

Do not use a screwdriver or any other metal object to remove fuses because it may cause a short circuit and damage the system.

Instrument panel fuse replacement



1. Turn the vehicle off.
2. Turn all other switches off.
3. Open the fuse panel cover.
4. Refer to the label on the inside of the fuse panel cover to locate the suspected fuse location.

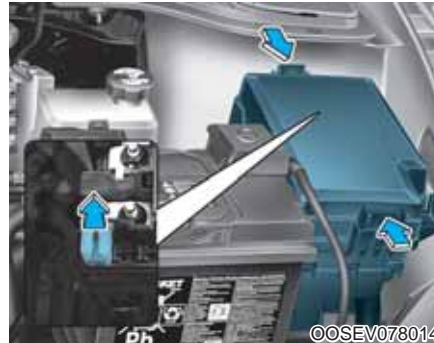

5. Pull the suspected fuse straight out. Use the removal tool provided in the motor compartment fuse panel.
6. Check the removed fuse; replace it if it is blown. Spare fuses are provided in the instrument panel fuse panels (or in the motor compartment fuse panel).
7. Push in a new fuse of the same rating, and make sure it fits tightly in the clips. If it fits loosely, we recommended that you consult an authorized HYUNDAI dealer.

In an emergency, if you do not have a spare fuse, use a fuse of the same rating from a circuit you may not need for operating the vehicle, such as the cigarette lighter fuse.

If the headlamps or other electrical components do not work and the fuses are OK, check the fuse panel in the motor compartment. If a fuse is blown, it must be replaced with the same rating.

Fuse switch



Always, place the fuse switch to the ON position.

If you move the switch to the OFF position, some items such as the audio system and digital clock must be reset and the smart key may not work properly.

i Information

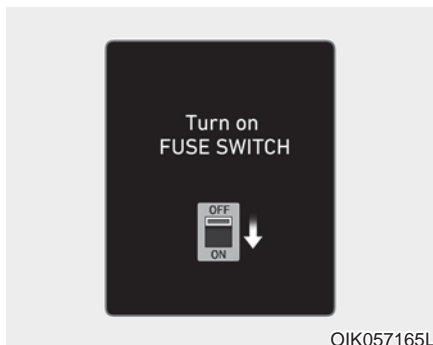

If the fuse switch is OFF, “Turn on FUSE SWITCH” message will appear.

NOTICE

- Always place the fuse switch in the ON position while driving the vehicle.
- Do not move the transportation fuse switch repeatedly. The fuse switch may be damaged.

Motor compartment panel fuse replacement

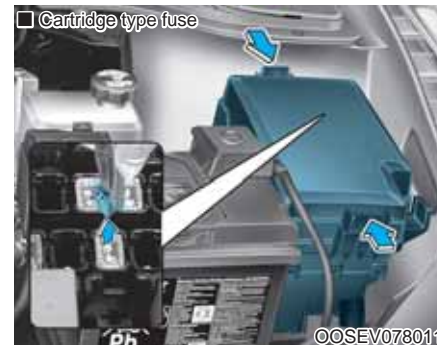

1. Turn the vehicle off.
2. Turn all other switches off.

3. Remove the fuse panel cover by pressing the tap and pulling up.
4. Check the removed fuse; replace it if it is blown. To remove or insert the fuse, use the removal tool in the motor compartment fuse panel.
5. Push in a new fuse of the same rating, and make sure it fits tightly in the clips. If it fits loosely, consult an authorized HYUNDAI dealer.

NOTICE

After checking the fuse panel in the motor compartment, securely install the fuse panel cover. You may hear a clicking sound if the cover is securely latched. If it is not securely latched, electrical failure may occur from water contact.

Multi fuse

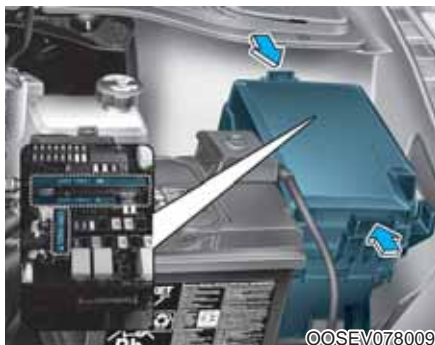

If the multi fuse is blown, we recommend that you consult an authorized HYUNDAI dealer.

Fuse/relay panel description

Instrument panel fuse panel



Inside the fuse/relay box cover, you can find the fuse/relay label describing fuse/relay name and capacity.





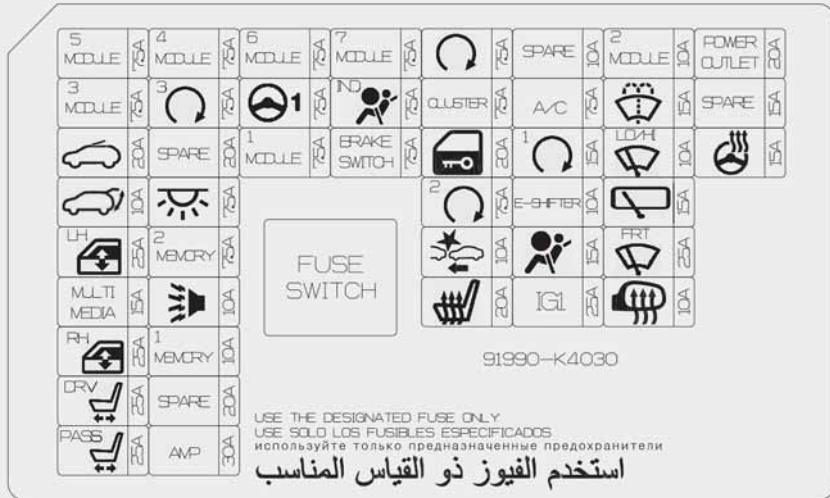

i Information

Not all fuse panel descriptions in this manual may be applicable to your vehicle; the information is accurate at the time of printing. When you inspect the fuse box on your vehicle, refer to the fuse box label.







OOSEV078039L







Driver's side fuse Panel

Fuse Name	Symbol	Fuse Rating	Circuit Protected
MODULE5	⁵ MODULE	7.5A	Electro Chromic Mirror, Audio, AMP, Head Lamp RH, A/V & Navigation Head Unit, Crash Pad Switch, Head Lamp LH, Auto Head Lamp Leveling Device Module, Front Air Ventilation Seat Module, Front Seat Warmer Module
MODULE3	³ MODULE	7.5A	Stop Switch, BCM
S/ROOF		20A	Sunroof Unit
T/Gate		10A	Tail Gate Relay
P/WDW LH	^{LH} 	25A	Power Window LH Relay, Driver Safety Power Window Module (LHD)
Multi Media	MULTI MEDIA	15A	Audio, A/V & Navigation Head Unit
P/WDW RH	^{RH} 	25A	Power Window RH Relay, Driver Safety Power Window Module (RHD)
DR/P/Seat	^{DRV} 	25A	Driver Seat Manual Switch
PS/P/Seat	^{PASS} 	25A	Passenger Seat Manual Switch
MODULE4	⁴ MODULE	7.5A	Blind-Spot Collision Warning Unit LH/RH, BCM, Crash Pad Switch, Vess Unit (Speaker), Multifunction Front View Camera
PDM3	³ 	7.5A	Smart Key Control Module
Spare	Spare	20A	Spare







Driver's side fuse Panel

Fuse Name	Symbol	Fuse Rating	Circuit Protected
INTERIOR LP		7.5A	Vanity Lamp LH/RH, Room Lamp, Overhead Console Lamp, Wireless Charger Unit, Luggage Lamp
MEMORY2	² MEMORY	7.5A	Vess Unit (Speaker), Electronic Refrigerant Reduced Pressure Valve
B/Alarm		10A	ICM Relay Box (Burglar Alarm Horn Relay)
MEMORY 1	¹ MEMORY	10A	A/C Control Module, Head Up Display, Instrument Cluster, BCM, Rain Sensor
Spare	Spare	20A	Spare
AMP	AMP	30A	AMP
MODULE6	⁶ MODULE	7.5A	Smart Key Control Module, BCM
MDPS	 ¹	7.5A	MDPS Unit
MODULE1	¹ MODULE	7.5A	Active Air Flap, ICM Relay Box (Outside Mirror Folding/Unfolding Relay), Hazard Switch, Data Link Connector
MODULE7	⁷ MODULE	7.5A	Front Air Ventilation Seat Module, Front Seat Warmer Module
A/BAG IND	 IND	7.5A	Instrument Cluster, A/C Control Module
BRAKE SWITCH	 BRAKE SWITCH	7.5A	Stop Lamp Switch, Smart Key Control Module







Driver's side fuse Panel

Fuse Name	Symbol	Fuse Rating	Circuit Protected
START		7.5A	Smart Key Control (With Smart Key), EPCU
CLUSTER	CLUSTER	7.5A	Head Up Display, Instrument Cluster
DR/LOCK		20A	Door Lock Relay, Door Unlock Relay, ICM Relay Box (Dead Lock Relay)
PDM2	² 	7.5A	Start/Stop Button Switch
FCA		10A	Forward Collision Avoidance Assist Unit
S/HTR		20A	Front Seat Warmer Module, Front Air Ventilation Seat Module
Spare	Spare	20A	Spare
A/CON	A/C	7.5A	A/C Control Module
PDM1	¹ 	15A	Smart Key Control Module
E-SHIFTER	^E SHIFTER	10A	Shift Select Switch (SBW), Front Console Switch
A/BAG		15A	SRS Control Module
IG1	IG1	25A	PCB Block (FUSE : F9, F11)

Driver's side fuse Panel

Fuse Name	Symbol	Fuse Rating	Circuit Protected
MODULE2		10A	Wireless Charger Unit, Smart Key Control Module, BCM, Audio, A/V & Navigation Head Unit, USB charger, AMP, Power Outside Mirror Switch
Washer		15A	Multifunction Switch
Wiper		10A	BCM
R/Wiper		15A	Rear Wiper Relay, Rear Wiper Motor
F/Wiper		25A	Front Wiper Motor, Motor Room Junction Block (Front Wiper (Low) Relay)
RR HTD		10A	Driver Power Outside Mirror, A/C Control Module
P/OUTLET	POWER OUTLET	20A	Power Outlet
SPARE	Spare	15A	Spare
HTD STRG		15A	BCM

Motor compartment fuse panel

Relay No.		Symbol	Relay Name
RLY.3	E63	² _(IG1) 	PDM #2 (IG1) Relay
RLY.5	E65	¹ IG3	IG3 #1 Relay
RLY.6	E66	³ _(IG2) 	PDM #3 (IG2) Relay
RLY.7	E67	² IG3	IG3 #2 Relay
RLY.8	E68	¹ _(ACC) 	PDM #1 (ACC) Relay
RLY.9	E69		Cooling Fan Relay
RLY.10	E70		Blower Relay
RLY.11	E71	E-SHIFTER	E-Shifter Relay
RLY.12	E72		Rear Defogger Relay



Motor compartment fuse panel

Type	Fuse Name	Symbol	Fuse Rating	Circuit Protected
MULTI FUSE-1	MAIN	MAIN	150A	Motor Room Junction Block (Fuse - F24, F26, F28), EPCU (LDC)
	MDPS	 1	80A	MDPS Unit
MULTI FUSE-2	BATT5	⁵ 	60A	PCB Block (Fuse - F7, F8, F14, F16), Ignition3 MAIN Relay
	BATT2	² 	60A	IGPM ((Fuse - F30), IPS0, IPS1, IPS2)
	BATT3	³ 	60A	IGPM (IPS3, IPS4 IPS5, IPS6, IPS7, IPS8)
	BATT4	⁴ 	50A	IGPM (Fuse - F3, F4, F5, F7, F8, F9, F15, F18)
	C/FAN		60A	Motor Room Junction Block (RLY.9)
	RR DEFOG		40A	Motor Room Junction Block (RLY.12)
	IG1	IG1	40A	Motor Room Junction Block (RLY.3, RLY.8)
	IG2	IG2	40A	Motor Room Junction Block (RLY.6)
MULTI FUSE-3	IEB4	⁴ IEB	40A	Electronic Brake Control Module
	BLOWER		40A	Motor Room Junction Block (RLY.10)

Motor compartment fuse panel

Type	Fuse Name	Symbol	Fuse Rating	Circuit Protected
FUSE	OBC	OBC	10A	OBC
	CHARGER2	² CHARGER	10A	ICM Relay Box (Charge Lock/Unlock Relay), CCM Unit
	IG3 5	⁵ IG3	20A	Motor Room Junction Block (RLY.5, RLY.7)
	BATT1	¹ 	40A	IGPM ((Fuse - F21, F24, F27, F28, F33) Leak Current Autocut Device)
	E-SHIFTER	E-SHIFTER	40A	Motor Room Junction Block ((Fuse - F34) RLY.11))
	CHARGER1	¹ CHARGER	10A	Charge Connector Door Module
	IEB1	¹ IEB	40A	Electronic Brake Control Module, Multipurpose Check Connector
	IEB2	² IEB	40A	Electronic Brake Control Module

Motor compartment fuse panel

Type	Fuse Name	Symbol	Fuse Rating	Circuit Protected
FUSE	IG3 3	³ IG3	10A	Motor Room Junction Block (RLY.9, RLY.10), Electronic A/C Compressor, 3Way Coolant Control Valve LH/RH
	E-SHIFTER3	³ E-SHIFTER	10A	SCU
	IG3 1	¹ IG3	15A	Motor Room Junction Block (RLY.5, RLY.7)
	ELECTRICAL WATER PUMP	ELECTRICAL WATER PUMP	15A	Electronic Water Pump
	IG3 2	² IG3	10A	BMU, OBC, EPCU
	EPCU1	¹ EPCU	15A	EPCU
	H/LAMP		10A	Head Lamp (High) Relay
	EPCU2	² EPCU	10A	EPCU
	IEB 3	³ IEB	10A	Electronic Brake Control Module, Multipurpose Check Connector
	IG3 4	⁴ IG3	15A	Active Air Flap, CCM Unit, Charge Connector Door Module, Air Conditioning PTC Heater, Crash Pad Switch, A/C Control Module, Audio, A/V & Navigation Head Unit, Instrument Cluster, IGPM
	BATTERY MANAGEMENT	BATTERY MANAGEMENT	10A	BMU
	HORN		15A	Horn Relay

Motor compartment fuse panel (Battery terminal cover)



Inside the fuse/relay box cover, you can find the fuse/relay label describing fuse/relay name and capacity.

i Information

Not all fuse panel descriptions in this manual may be applicable to your vehicle; the information is accurate at the time of printing. When you inspect the fuse panel in your vehicle, refer to the fuse panel label.



NOTICE

After checking the fuse panel in the motor compartment, securely install the cover. If it is not securely latched, electrical failure may occur from water contact.

LIGHT BULBS

Consult an authorized HYUNDAI dealer to replace most vehicle light bulbs. It is difficult to replace vehicle light bulbs because other parts of the vehicle must be removed before you can get to the bulb. This is especially true for removing the headlamp assembly to get to the bulb(s).

Removing/installing the headlamp assembly can result in damage to the vehicle.

WARNING

- Prior to working on a light, depress the foot brake, shift to P (Park), apply the parking brake, place the START/STOP button in the OFF position and take the key with you when leaving the vehicle to avoid sudden movement of the vehicle and to prevent possible electric shock.
- Be aware the bulbs may be hot and may burn your fingers.

NOTICE

Be sure to replace the burned-out bulb with one of the same wattage rating. Otherwise, it may cause damage to the fuse or electrical wiring system.

Information

After heavy driving rain or washing, the lamps could appear frosty. This condition is caused by the temperature difference between the lamp inside and the outside temperature. This is similar to the condensation on your windows inside your vehicle when raining and doesn't indicate a problem with your vehicle. If the water leaks into the light bulb circuitry, have your vehicle checked by an authorized HYUNDAI dealer.

Information

- A normally functioning lamp may flicker momentarily to stabilize the vehicle's electrical control system. However, if the lamp goes out after flickering momentarily, or continues to flicker, we recommend the system be checked by an authorized HYUNDAI dealer.
- The position lamp may not turn on when the position lamp switch is turned on, but the position lamp and headlamp switch may turn on when the headlamp switch is turned on. This may be caused by network failure or vehicle electrical control system malfunction. If this occurs, we recommend the system be checked by an authorized HYUNDAI dealer.

i Information

The headlamp aiming should be adjusted after an accident or after the headlamp assembly is reinstalled at an authorized HYUNDAI dealer.

Headlamp, daytime running light (DRL), position lamp, turn signal lamp and static lamp bulb replacement

Type A



- (1) Headlamp (High)
- (2) Headlamp (Low)
- (3) Daytime running light (DRL)/
Position lamp
- (4) Turn signal lamp



Headlamp

1. Open the hood.
2. Disconnect the negative battery cable.

3. Remove the bulb cover by turning it counterclockwise.
4. Remove the bulb socket from the headlamp assembly by turning it counterclockwise
5. Disconnect the bulb socket-connector.
6. Reinstall in the reverse order of removal.

⚠ WARNING



OIG076039

- **Handle halogen bulbs with care. Halogen bulbs contain pressurized gas that will produce flying pieces of glass that could cause injuries if broken.**
- **Wear eye protection when changing a bulb. Allow the bulb to cool down before handling it.**

- Always handle them carefully, and avoid scratches and abrasions. If the bulbs are lit, avoid contact with liquids.
- Never touch the glass with bare hands. Residual oil may cause the bulb to overheat and burst when lit.
- A bulb should be operated only when installed in a headlamp.
- If a bulb becomes damaged or cracked, replace it immediately and carefully dispose of it.

Daytime running light (DRL)/ Position lamp

If the lamp (LED) does not operate, we recommend that the system be checked by an authorized HYUNDAI dealer.

The LED lamps cannot be replaced as a single unit because it is an integrated unit. The LED lamps has to be replaced with the unit.

A skilled technician should check or repair the LED lamp, for it may damage related parts of the vehicle.

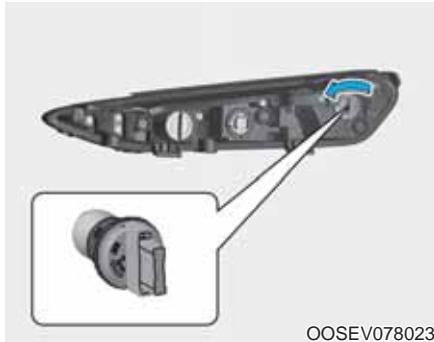

Turn signal lamp

1. Open the hood.
2. Disconnect the negative battery cable.
3. Remove the socket from the assembly by turning the socket counterclockwise until the tabs on the socket align with the slots on the assembly.
4. Remove the bulb from the socket by pressing it in and rotating it counterclockwise until the tabs on the bulb align with the slots in the socket. Pull the bulb out of the socket.

5. Insert a new bulb by inserting it into the socket and rotating it until it locks into place.
6. Install the socket into the assembly by aligning the tabs on the socket with the slots in the assembly.
7. Push the socket into the assembly and turn the socket clockwise.

Type B



- (1) Static lamp (Low beam assist)
- (2) Headlamp (Low/High)
- (3) Daytime running light (DRL)/
Position lamp
- (4) Turn signal lamp

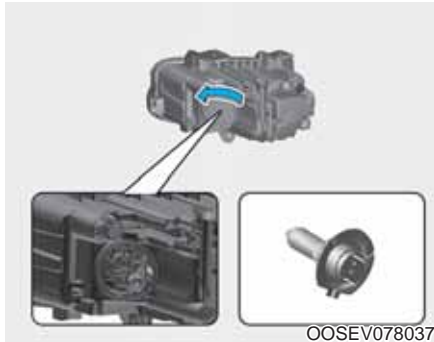

Static lamp (Low beam assist)

1. Open the hood.
2. Disconnect the negative battery cable.
3. Remove the bulb cover by turning it counterclockwise.
4. Remove the bulb socket from the headlamp assembly by turning it counterclockwise.
5. Disconnect the bulb socket-connector.
6. Reinstall in the reverse order of removal.

⚠ WARNING

- **Handle halogen bulbs with care. Halogen bulbs contain pressurized gas that will produce flying pieces of glass that could cause injuries if broken.**
- **Wear eye protection when changing a bulb. Allow the bulb to cool down before handling it.**

- Always handle them carefully, and avoid scratches and abrasions. If the bulbs are lit, avoid contact with liquids.
- Never touch the glass with bare hands. Residual oil may cause the bulb to overheat and burst when lit.
- A bulb should be operated only when installed in a headlamp.
- If a bulb becomes damaged or cracked, replace it immediately and carefully dispose of it.

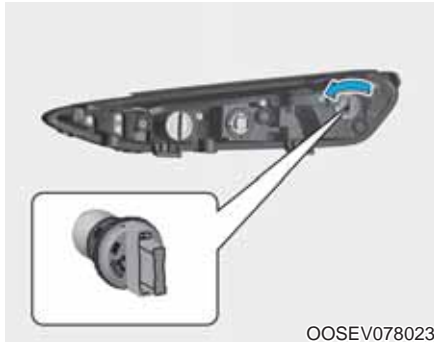

OOSEV078023

Turn signal lamp

1. Open the hood.
2. Disconnect the negative battery cable.
3. Remove the socket from the assembly by turning the socket counterclockwise until the tabs on the socket align with the slots on the assembly.
4. Remove the bulb from the socket by pressing it in and rotating it counterclockwise until the tabs on the bulb align with the slots in the socket. Pull the bulb out of the socket.
5. Insert a new bulb by inserting it into the socket and rotating it until it locks into place.
6. Install the socket into the assembly by aligning the tabs on the socket with the slots in the assembly.
7. Push the socket into the assembly and turn the socket clockwise.

Headlamp (Low/High) and Daytime running light (DRL)/Position lamp

If the lamp (LED) does not operate, we recommend that the system be checked by an authorized HYUNDAI dealer.

The LED lamps cannot be replaced as a single unit because it is an integrated unit. The LED lamps has to be replaced with the unit.

A skilled technician should check or repair the LED lamp, for it may damage related parts of the vehicle.

Side repeater lamp replacement



If the lamp (LED) (1) does not operate, we recommend that the system be checked by an authorized HYUNDAI dealer.

The LED lamps cannot be replaced as a single unit because it is an integrated unit. The LED lamps has to be replaced with the unit.

A skilled technician should check or repair the LED lamp, for it may damage related parts of the vehicle.

Rear combination lamp bulb replacement

Type A



- (1) Stop/Tail lamp
- (2) Tail lamp
- (3) Turn signal lamp
- (4) Fog lamp
- (5) Backup lamp



Stop and Tail lamp

1. Turn off the vehicle.
2. Open the tailgate.
3. Loosen the lamp assembly retaining screws with a cross-tip screwdriver.



4. Remove the rear combination lamp assembly from the body of the vehicle.

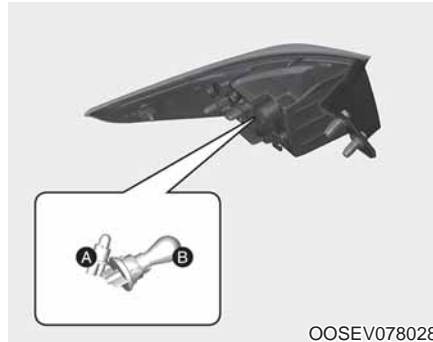

5. Remove the socket from the assembly by turning the socket counterclockwise until the tabs on the socket align with the slots on the assembly.

6.- Stop lamp (A)

Remove the bulb from the socket by pressing it in and rotating it counterclockwise until the tabs on the bulb align with the slots in the socket. Pull the bulb out of the socket.

- Tail lamp (B)

Remove the bulb from the socket by pulling out the bulb.

7. Reinstall in the reverse order of removal.



Tail lamp

1. Turn off the vehicle.
2. Open the tailgate.
3. Remove the service cover using a flat-blade screwdriver.

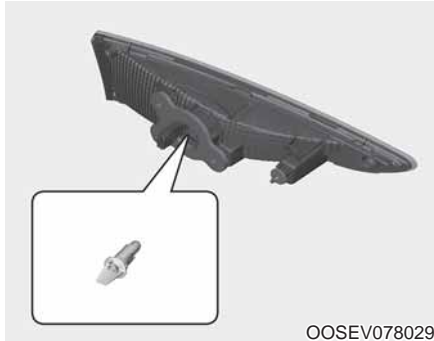

OOSEV078029

4. Remove the socket from the assembly by turning the socket counterclockwise until the tabs on the socket align with the slots on the assembly.
5. Remove the bulb from the socket by pulling out the bulb.
6. Reinstall in the reverse order of removal.

Turn signal lamp, fog lamp and backup lamp

If the lamp does not operate, we recommend that you have the vehicle checked by an authorized HYUNDAI dealer.

Type B



OOSEV078031L

- (1) Stop/tail lamp
- (2) Stop/tail lamp
- (3) Turn signal lamp
- (4) Fog lamp
- (5) Backup lamp

Stop/tail lamp

If the lamp (LED) does not operate, we recommend that the system be checked by an authorized HYUNDAI dealer.

The LED lamps cannot be replaced as a single unit because it is an integrated unit. The LED lamps has to be replaced with the unit.

A skilled technician should check or repair the LED lamp, for it may damage related parts of the vehicle.

Turn signal lamp, fog lamp and backup lamp

If the lamp does not operate, we recommend that you have the vehicle checked by an authorized HYUNDAI dealer.

High mounted stop lamp bulb replacement



If the lamp (LED) (1) does not operate, we recommend that the system be checked by an authorized HYUNDAI dealer.

The LED lamps cannot be replaced as a single unit because it is an integrated unit. The LED lamps has to be replaced with the unit.

A skilled technician should check or repair the LED lamp, for it may damage related parts of the vehicle.

License plate light bulb replacement



1. Loosen the lens retaining screws with a philips head screwdriver.
2. Remove the lens.
3. Remove the socket by turning it counterclockwise.
4. Remove the bulb by pulling it straight out.
5. Install a new bulb.
6. Reinstall in the reverse order of removal.

Interior light bulb replacement

Map lamp, room lamp and luggage compartment lamp (LED type)



If the lamp (LED) does not operate, we recommend that the system be checked by an authorized HYUNDAI dealer.

The LED lamps cannot be replaced as a single unit because it is an integrated unit. The LED lamps has to be replaced with the unit.

A skilled technician should check or repair the LED lamp, for it may damage related parts of the vehicle.

Map lamp, room lamp, vanity mirror lamp and luggage compartment lamp (Bulb type)

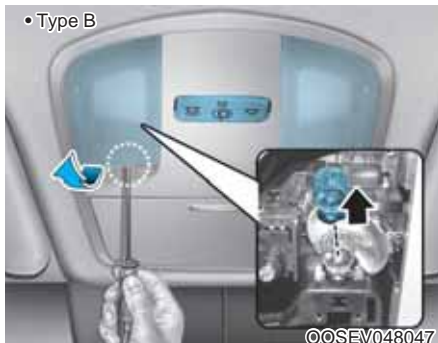
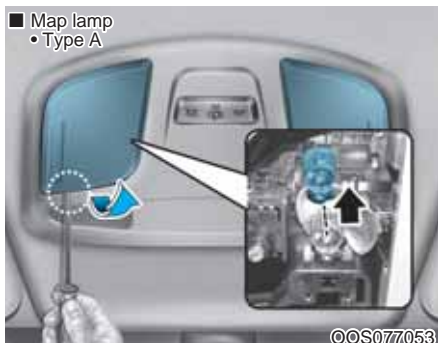

1. Using a flat-head screwdriver, gently pry the lens from the interior light housing.
2. Remove the bulb by pulling it straight out.
3. Install a new bulb into the socket.
4. Align the lens tabs with the interior light housing notches and snap the lens into place.

NOTICE

Use care not to dirty or damage lenses, lens tabs, and plastic housings.

APPEARANCE CARE

Exterior care

If you park your vehicle near a stainless steel sign or glass facade building, the vehicle's exterior plastic parts such as a bumper, spoiler, garnish, lamp or exterior mirror might be damaged due to sunlight reflected from the sign or building. To prevent damage of the exterior plastic parts, you should avoid parking in areas where light may be reflected or use a car cover. (The exterior plastic parts applied to your vehicle may vary.)

Exterior general caution

It is very important to follow the label directions when using any chemical cleaner or polish. Read all warning and caution statements that appear on the label.

High-pressure washing

- When using high-pressure washers, make sure to maintain sufficient distance from the vehicle. Insufficient clearance or excessive pressure can lead to component damage or water penetration.

- Do not spray the camera, sensors or its surrounding area directly with a high pressure washer. Shock applied from high pressure water may cause the device to not operate normally.
- Do not bring the nozzle tip close to boots (rubber or plastic covers) or connectors as they may be damaged if they come into contact with high pressure water.

Protecting your vehicle's finish

Washing

To help protect your vehicle's finish from rust and deterioration, wash it thoroughly and frequently at least once a month with lukewarm or cold water.

If you use your vehicle for off-road driving, you should wash it after each off-road trip. Pay special attention to the removal of any accumulation of salt, dirt, mud, and other foreign materials. Make sure the drain holes in the lower edges of the doors and rocker panels are kept clear and clean.

Insects, tar, tree sap, bird droppings, industrial pollution and similar deposits can damage your vehicle's finish if not removed immediately.

Even prompt washing with plain water may not completely remove all these deposits. A mild soap, safe for use on painted surfaces, should be used.

After washing, rinse the vehicle thoroughly with lukewarm or cold water. Do not allow soap to dry on the finish.

WARNING

After washing the vehicle, test the brakes while driving slowly to see if they have been affected by water before getting on the road. If braking performance is impaired, dry the brakes by applying them lightly while maintaining a slow forward speed.

NOTICE

- Do not use strong soap, chemical detergents or hot water, and do not wash the vehicle in direct sunlight or when the body of the vehicle is warm.
- Be careful when washing the side windows of your vehicle. Especially, with high-pressure water, water may leak through the windows and wet the interior.
- To prevent damage to the plastic parts, do not clean with chemical solvents or strong detergents.
- To prevent damage to the charging door, make sure to close and lock the vehicle doors when washing (high-pressure washing, automatic car washing, etc.) the vehicle.



NOTICE

- Water washing in the motor compartment including high pressure water washing may cause the failure of electrical circuits located in the motor compartment.
- Never allow water or other liquids to come in contact with electrical/electronic components inside the vehicle as this may damage them.

Waxing

A good coat of wax is a barrier between your paint and contaminate. Keeping a good coat of wax on your vehicle will help protect it.

Wax the vehicle when water will no longer bead on the paint.

Always wash and dry the vehicle before waxing. Use a good quality liquid or paste wax, and follow the manufacturer's instructions. Wax all metal trim to protect it and to maintain its luster.

Removing oil, tar, and similar materials with a spot remover will usually strip the wax from the finish. Be sure to re-wax these areas even if the rest of the vehicle does not yet need waxing.

NOTICE

- **Wiping dust or dirt off the body with a dry cloth will scratch the finish.**
- **Do not use steel wool, abrasive cleaners, or strong detergents containing highly alkaline or caustic agents on chrome-plated or anodized aluminum parts. This may result in damage to the protective coating and cause discoloration or paint deterioration.**

Repairing your vehicle's finish

Deep scratches or stone chips in the painted surface must be repaired promptly. Exposed metal will quickly rust and may develop into a major repair expense.

NOTICE

If your vehicle is damaged and requires any metal repair or replacement, be sure the body shop applies anti-corrosion materials to the parts repaired or replaced.

Bright-metal maintenance

- To remove road tar and insects, use a tar remover, not a scraper or other sharp object.
- To protect the surfaces of bright-metal parts from corrosion, apply a coating of wax or chrome preservative and rub to a high luster.
- During winter weather or in coastal areas, cover the bright metal parts with a heavier coating of wax or preservative. If necessary, coat the parts with non-corrosive petroleum jelly or other protective compound.

Underbody maintenance

Corrosive materials used for ice and snow removal and dust control may collect on the underbody. If these materials are not removed, accelerated rusting can occur on underbody parts such as the fuel lines, frame, floor pan and exhaust system, even though they have been treated with rust protection.

Thoroughly flush the vehicle underbody and wheel openings with lukewarm or cold water once a month, after off-road driving and at the end of each winter. Pay special attention to these areas because it is difficult to see all the mud and dirt. It will do more harm than good to wet down the road grime without removing it. The lower edges of doors, rocker panels, and frame members have drain holes that should not be allowed to clog with dirt; trapped water in these areas can cause rusting.

 **WARNING**

After washing the vehicle, test the brakes while driving slowly to see if they have been affected by water. If braking performance is impaired, dry the brakes by applying them lightly while maintaining a slow forward speed.

Aluminum wheel maintenance

The aluminum wheels are coated with a clear protective finish.

NOTICE

- **Do not use abrasive cleaner, polishing compound, solvent, or wire brushes on aluminum wheels.**
- **Clean the wheel when it has cooled.**
- **Use only a mild soap or neutral detergent, and rinse thoroughly with water. Also, clean the wheels after driving on salted roads.**
- **Do not wash the wheels with high-speed car wash brushes.**
- **Do not use any cleaners containing acid or alkaline detergents.**

Corrosion protection

Protecting your vehicle from corrosion

By using the most advanced design and construction practices to combat corrosion, HYUNDAI produces vehicles of the highest quality. However, this is only part of the job. To achieve the long-term corrosion resistance your vehicle can deliver, the owner's cooperation and assistance is also required.

Common causes of corrosion

The most common causes of corrosion on your vehicle are:

- Road salt, dirt and moisture that is allowed to accumulate underneath the vehicle.
- Removal of paint or protective coatings by stones, gravel, abrasion or minor scrapes and dents which leave unprotected metal exposed to corrosion.

High-corrosion areas

If you live in an area where your vehicle is regularly exposed to corrosive materials, corrosion protection is particularly important. Some of the common causes of accelerated corrosion are road salts, dust control chemicals, ocean air and industrial pollution.

Moisture breeds corrosion

Moisture creates the conditions in which corrosion is most likely to occur. For example, corrosion is accelerated by high humidity, particularly when temperatures are just above freezing. In such conditions, the corrosive material is kept in contact with the vehicle surfaces by moisture that is slow to evaporate.

Mud is particularly corrosive because it is slow to dry and holds moisture in contact with the vehicle. Although the mud appears to be dry, it can still retain moisture and promote corrosion.

High temperatures can also accelerate corrosion of parts that are not properly ventilated so the moisture can be dispersed. For all these reasons, it is particularly important to keep your vehicle clean and free of mud or accumulations of other materials. This applies not only to the visible surfaces but particularly to the underside of the vehicle.

To help prevent corrosion

Keep your vehicle clean

The best way to prevent corrosion is to keep your vehicle clean and free of corrosive materials. Attention to the underside of the vehicle is particularly important.

- If you live in a high-corrosion area — where road salts are used, near the ocean, areas with industrial pollution, acid rain, etc.—, you should take extra care to prevent corrosion. In winter, hose off the underside of your vehicle at least once a month and be sure to clean the underside thoroughly when winter is over.

- When cleaning underneath the vehicle, pay particular attention to the components under the fenders and other areas that are hidden from view. Do a thorough job; just dampening the accumulated mud rather than washing it away will accelerate corrosion rather than prevent it. Water under high pressure and steam are particularly effective in removing accumulated mud and corrosive materials.
- When cleaning lower door panels, rocker panels and frame members, be sure that drain holes are kept open so that moisture can escape and not be trapped inside to accelerate corrosion.

Keep your garage dry

Don't park your vehicle in a damp, poorly ventilated garage. This creates a favorable environment for corrosion. This is particularly true if you wash your vehicle in the garage or drive it into the garage when it is still wet or covered with snow, ice or mud. Even a heated garage can contribute to corrosion unless it is well ventilated so moisture is dispersed.

Keep paint and trim in good condition

Scratches or chips in the finish should be covered with "touch-up" paint as soon as possible to reduce the possibility of corrosion. If bare metal is showing through, the attention of a qualified body and paint shop is recommended.

Bird droppings are highly corrosive and may damage painted surfaces in just a few hours. Always remove bird droppings as soon as possible.

Interior care

Interior general precautions

Prevent caustic solutions such as perfume and cosmetic oil, from contacting the interior parts because they may cause damage or discoloration. If they do contact the interior parts, wipe them off immediately. See the instructions for the proper way to clean vehicle interior surfaces.

NOTICE

- **Never allow water or other liquids to come in contact with electrical/electronic components inside the vehicle as this may damage them.**
- **When cleaning leather products (steering wheel, seats etc.), use neutral detergents or low alcohol content solutions. If you use high alcohol content solutions or acid/alkaline detergents, the color of the leather may fade or the surface may get stripped off.**

Cleaning the upholstery and interior trim

Vehicle interior surfaces (if equipped)

Remove dust and loose dirt from interior surfaces with a whisk broom or a vacuum cleaner. If necessary, clean interior surfaces with a mixture of warm water and mild non-detergent cleaner (test all cleaners on a concealed area before use).

Fabric (if equipped)

Remove dust and loose dirt from fabric with a whisk broom or vacuum cleaner. Clean with a mild soap solution recommended for upholstery or carpets. Remove fresh spots immediately with a fabric spot cleaner. If fresh spots do not receive immediate attention, the fabric can be stained and its color can be affected. Also, its fire-resistant properties can be reduced if the material is not properly maintained.

NOTICE

Using anything but recommended cleaners and procedures may affect the fabric's appearance and fire-resistant properties.

Leather (if equipped)

- Features of seat leather
 - Leather is made from the outer skin of an animal, which goes through a special process to be available for use. Since it is a natural product, each part differs in thickness or density.
Wrinkles may appear as a natural result of stretching and shrinking depending on the temperature and humidity.
 - The seat is made of stretchable fabric to improve comfort.
 - The parts contacting the body are curved and the side supporting area is high which provides driving comfort and stability.
 - Wrinkles may appear naturally from usage. It is not a fault of the products.

NOTICE

- **Wrinkles or abrasions which appear naturally from usage are not covered by warranty.**
- **Belts with metallic accessories, zippers or keys inside the back pocket may damage the seat fabric.**
- **Make sure not to wet the seat. It may change the nature of natural leather.**
- **Jeans or clothes which could bleach may contaminate the surface of the seat covering fabric.**

- Caring for the leather seats
 - Vacuum the seat periodically to remove dust and sand on the seat. It will prevent abrasion or damage of the leather and maintain its quality.
 - Wipe the natural leather seat cover often with dry or soft cloth.
 - Use of proper leather protector may prevent abrasion of the cover and helps maintain the color. Be sure to read the instructions and consult a specialist when using leather coating or protective agent.
 - Light colored (beige, cream beige) leather is easily contaminated and the stain is noticeable. Clean the seats frequently.
 - Avoid wiping with wet cloth. It may cause the surface to crack.

- Cleaning the leather seats
 - Remove all contaminations instantly. Refer to instructions below for removal of each contaminant.
 - Cosmetic products (sunscreen, foundation, etc.)

Apply cleansing cream on a cloth and wipe the contaminated spot. Wipe off the cream with a wet cloth and remove water with a dry cloth.
 - Beverages (coffee, soft drink, etc.)

Apply a small amount of neutral detergent and wipe until contaminations do not smear.
 - Oil

Remove oil instantly with absorbable cloth and wipe with stain remover used only for natural leather.
 - Chewing gum

Harden the gum with ice and remove gradually.

Cleaning the seat belt webbing

Clean the belt webbing with any mild soap solution recommended for cleaning upholstery or carpet. Follow the instructions provided with the soap. Do not bleach or re-dye the webbing because this may weaken the seat belt.

Cleaning the interior window glass

If the interior glass surfaces of the vehicle become fogged (that is, covered with an oily, greasy or waxy film), they should be cleaned with glass cleaner. Follow the directions on the glass cleaner container.

NOTICE

Do not scrape or scratch the inside of the rear window. This may result in damage to the rear window defroster grid.

Specifications & Consumer Information

Dimensions.....	9-2
Electric vehicle specifications	9-2
Bulb wattage.....	9-3
Tires and wheels.....	9-4
Air conditioning system	9-5
Volume and weight	9-5
Recommended lubricants and capacities	9-6
Vehicle identification number (VIN).....	9-7
Vehicle certification label.....	9-7
Tire specification and pressure label	9-8
Motor number	9-8
Air conditioner compressor label	9-8

DIMENSIONS

Items	mm (in)
Overall length	4180 (164.6)
Overall width	1800 (70.9)
Overall height	1555 (61.2) / 1570 (61.8)*1
Front tread	1564 (61.6)
Rear tread	1575 (62.0)
Wheelbase	2600 (102.4)

*1 : with roof rack

ELECTRIC VEHICLE SPECIFICATIONS

Items		Economy type	Extended type*
Motor	Max. output	100 kW	150 kW
	Max. torque	395 Nm	395 Nm
Battery (Lithium-ion Polymer)	Capacity	39.2 kWh	64 kWh
	Power out-put	104 kW	170 kW
	Voltage	327 V	356 V
Charger (OBC)	Max. Output	7.2 kW	7.2 kW

OBC : On-Board Battery Chargers

* If equipped

BULB WATTAGE

Light bulb			Bulb type	Wattage	
Front	Type A	Headlamp	Low	H7	55
			High	H7	55
	Type B	Headlamp	Low/High	LED	LED
			Static lamp (Low beam assist)	H7	55
	Turn signal lamp			PY21W	21
	Daytime running light (DRL)/Position lamp			LED	LED
Side repeater lamp			LED	LED	
Rear	Type A	Tail/Stop lamp		P21W/5W	Tail: 5 / Stop: 21
		Tail lamp		W5W	5
	Type B	Tail/Stop lamp		LED	LED
	Turn signal lamp			PY21W	21
	Backup lamp			P21W	21
	Fog lamp			PR21W	21
	License plate lamp			W5W	5
	High mounted stop lamp			LED	LED
Interior	Map lamp		Type A	W10W	10
			Type B	LED	LED
	Room lamp		Type A	FESTOON	8
			Type B	LED	LED
	Vanity mirror lamp			FESTOON	5
	Luggage compartment lamp		Type A	FESTOON	10
Type B			LED	LED	

TIRES AND WHEELS

Item	Tire size	Wheel size	Inflation pressure, bar (KPa, psi)				Wheel lug nut torque kgfm (lbf.ft, N.m)
			Normal load ^{*1}		Maximum load		
			Front	Rear	Front	Rear	
Full size tire	215/55 R17	7.0J X 17	2.5 (250, 36)				11~13 (79~94, 107~127)
Spare tire	T135/80 D17	4T X 7					

*1 : Normal load : Up to 3 persons

NOTICE

- It is permissible to add 20 kPa (3 psi) to the standard tire pressure specification if colder temperatures are expected soon. Tires typically lose 7 kPa (1 psi) for every 7°C (12°F) temperature drop. If extreme temperature variations are expected, recheck your tire pressure as necessary to keep them properly inflated.
- An air pressure generally decreases, as you drive up to a high-altitude area above sea level. Thus, if you plan to drive a high-altitude area, check the tire pressures in advance. If necessary, inflate them to a proper level (Air inflation per altitude: +10 kPa/1 km (+2.4 psi/1 mile)).
- Spare tire are intended for emergency purpose only.
- Only steel wheel is provided as spare wheel. Spare tire can be from any manufacturer.

CAUTION

**When replacing tires, use the same size originally supplied with the vehicle.
Using tires of a different size can damage the related parts or not work properly.**

AIR CONDITIONING SYSTEM

Items		Weight of volume	Classification
Refrigerant g (oz.)	With standard climate control system	550 ±25 (19.4 ± 0.9)	R-1234yf
			R-134a
	With inner condenser	650 ± 25 (22.9 ± 0.9)	R-1234yf
			R-134a
	With heat pump	1000 ±25 (35.3 ± 0.9)	R-1234yf
			R-134a
Compressor lubricant g (oz.)		180 ± 10 (6.34 ± 0.35)	POE

Contact an authorized HYUNDAI dealer for more details.

VOLUME AND WEIGHT

Gross vehicle weight	Luggage volume	
	Min.	Max.
2020 kg (4453 lbs.)	332 / (11.7 cu ft)	1114 / (39.3 cu ft)

Min : Behind rear seat to roof

Max : Behind front seat to roof

RECOMMENDED LUBRICANTS AND CAPACITIES

To help achieve proper vehicle performance and durability, use only lubricants of the proper quality. These lubricants and fluids are recommended for use in your vehicle.

Lubricant		Volume	Classification
Reduction gear fluid		1.0 ~ 1.1 l (1.0 ~ 1.1 US qt.)	70W, API GL-4, TCGO-9(MS517-14)
Coolant	Economical type	without heat pump	Designated coolant water for electric vehicles
		with heat pump	
	Extended type (If applicable)	without heat pump	
		with heat pump	
Brake fluid		0.7 ~ 0.8 l (0.74 ~ 0.85 US qt.)	SAE J1704 DOT3 or DOT4, FMVSS 116 DOT-4 ISO 4925 CLASS-6

* : We recommend that you use the oils/coolants approved by HYUNDAI Motor India Ltd. We recommend that you consult an EV specialised and approved HYUNDAI dealer for details.

VEHICLE IDENTIFICATION NUMBER (VIN)

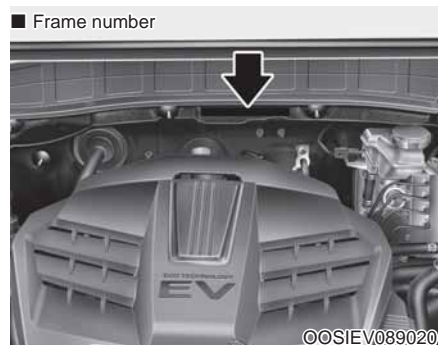

The vehicle identification number (VIN) is the number used in registering your vehicle and in all legal matters pertaining to its ownership, etc.

The number is punched on the cowl lower member in engine room.

To check the number, open the hood.



The VIN is also on a plate attached to the top of the dashboard. The number on the plate can easily be seen through the windshield from outside.

VEHICLE CERTIFICATION LABEL



The vehicle certification label attached on the driver's (or front passenger's) side center pillar gives the vehicle identification number (VIN).

TIRE SPECIFICATION AND PRESSURE LABEL

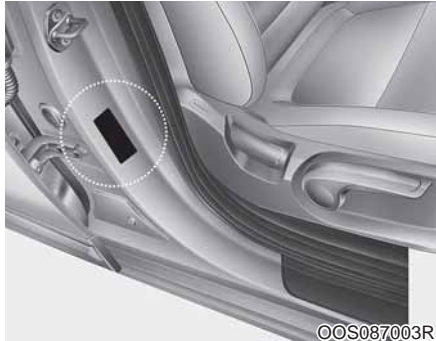

The tires supplied on your new vehicle are chosen to provide the best performance for normal driving. The tire label located on the driver's (or passenger's) side center pillar gives the tire pressures recommended for your vehicle.

MOTOR NUMBER

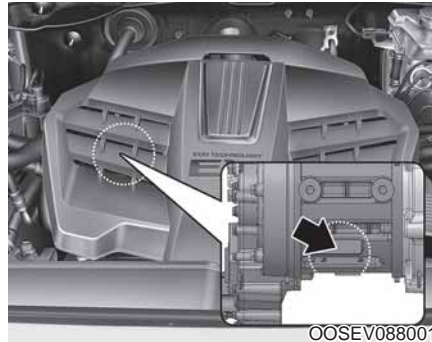

The motor number is stamped on the motor block as shown in the drawing. The motor number can be seen from under the vehicle.

AIR CONDITIONER COMPRESSOR LABEL

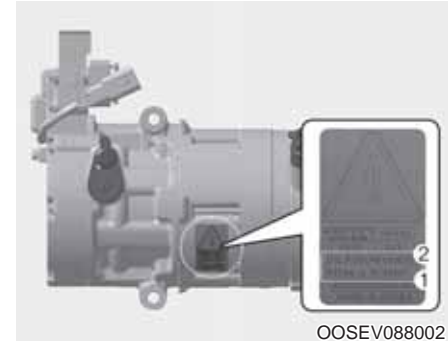

A compressor label informs you the type of compressor your vehicle is equipped with such as model, supplier part number, production number, refrigerant (1) and refrigerant oil (2).